

# Installation & Service Manual

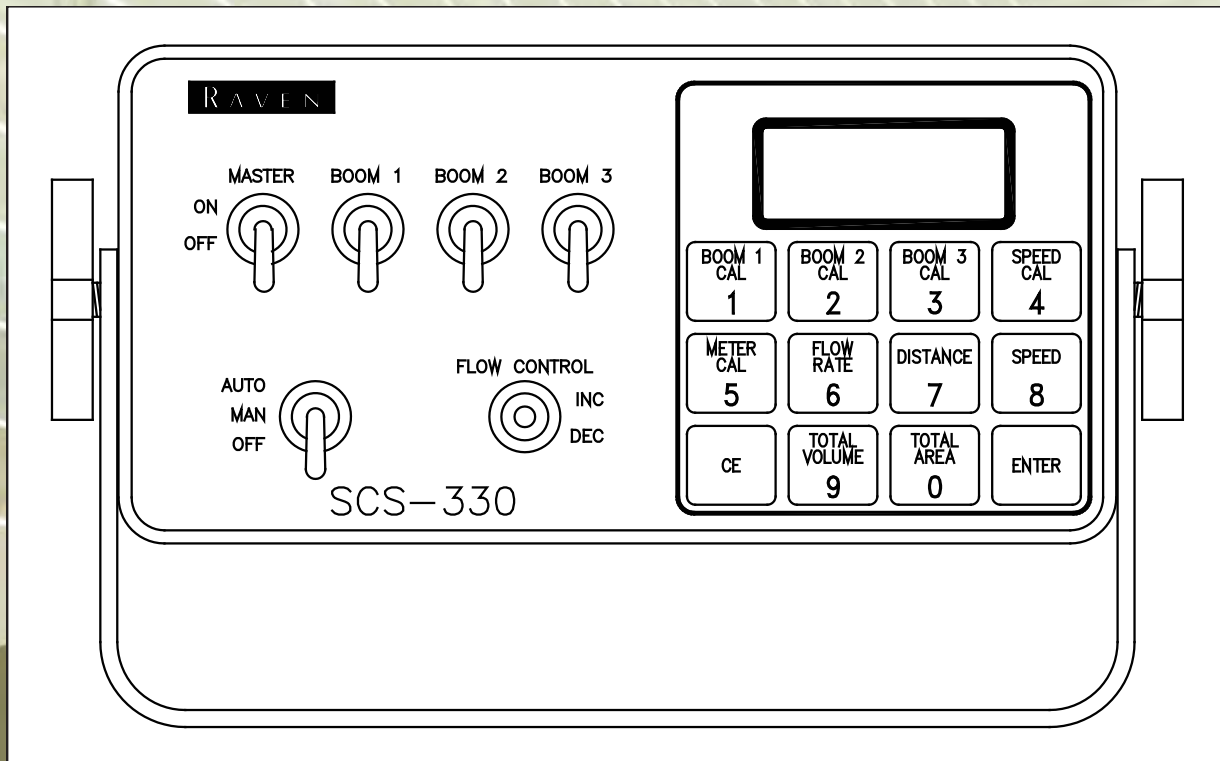

## N O T I C E

The use of the suspension type fertilizers and lime slurries will significantly reduce the life of the plastic parts in the Flow Meter and motorized Control Valve. Check the rotor and inlet hub assembly in the Flow Meter frequently for worn parts. Excessive wear can affect accuracy.

Do not attempt to modify or lengthen any of the three-wire Speed Sensor or Flow Meter cables. Extension cables are available from your Dealer.

# TABLE OF CONTENTS

SYMBOL DEFINITION .....	2
INTRODUCTION .....	3
INSTALLATION .....	4
1. MOUNTING THE RAVEN RADAR SPEED SENSOR .....	4
2. MOUNTING THE FLOW METER .....	5
3. MOUNTING THE CONTROL VALVE .....	5
4. MOUNTING THE CONSOLE AND CABLING .....	6
BATTERY CONNECTIONS .....	7
CONSOLE FEATURES .....	8
CONSOLE CALIBRATION .....	9
1. CALCULATING "BOOM CAL" .....	9
2. CALCULATING "SPEED CAL" .....	10
3. CALCULATING "METER CAL" .....	11
4. CALCULATING "VALVE CAL" .....	11
5. CALCULATING "RATE CAL" .....	12
CONSOLE PROGRAMMING .....	13
1. INITIAL CONSOLE PROGRAMMING .....	14
2. OTHER DISPLAY FEATURES .....	16
3. SELF TEST FEATURE .....	17
4. ALARM MENU .....	17
5. OFF TARGET ALARM .....	17
6. AUTOMATIC RATE +/- .....	18
7. LOW LIMIT FLOW SET POINT AND LOW LIMIT ALARM .....	18
8. DISPLAY SMOOTHING .....	18
9. "VALVE CAL" .....	19
10. CONTROL VALVE DELAY .....	19
11. SEQUENCE TO ACTIVATE DATA-LOCK .....	19
12. SEQUENCE TO CHANGE DATA-LOCK .....	19
13. ENTER MODE SEQUENCE WITH ACTIVATED DATA-LOCK .....	20
INITIAL SYSTEM SET-UP .....	20
INITIAL SYSTEM FIELD TEST .....	21
PREVENTIVE MAINTENANCE .....	21

---

## APPENDIXES

---

1. WHEEL DRIVE SPEED SENSOR INSTALLATION AND CALIBRATION .....	22
2. SPEEDOMETER DRIVE SPEED SENSOR INSTALLATION AND CALIBRATION .....	25
3. ALTERNATE BY-PASS LINE PLUMBING SYSTEM .....	27
4. PROCEDURE TO TEST SPEED SENSOR EXTENSION CABLES .....	29
5. PROCEDURE TO TEST FLOW METER CABLES .....	30
6. FLOW METER MAINTENANCE AND ADJUSTMENT PROCEDURE .....	31
7. PROCEDURE TO RE-CALIBRATE FLOW METER .....	32
8. REMOTE SWITCH OPTION .....	33
9. HIDDEN FEATURES .....	34

REPLACEMENT PARTS SHEETS

# SYMBOL DEFINITION

GPM	- Gallons per minute	cm	- Centimeters
lit/min	- Liters per minute	dm	- Decimeters
dl/min	- Deciliter per minute	m	- Meter
PSI	- Pounds per square inch	MPH	- Miles per hour
kPa	- Kilopascal	km	- Kilometers
GPA	- Gallon per acre	km/h	- Kilometers per hour
lit/ha	- Liter per hectare	US	- Volume per ACRE
ml/ha	- Milliliter per hectare	SI	- Volume per HECTARE
GPK	- Gallons per 1,000 sq. ft.	TU	- Volume per 1,000 sq. ft.
mm	- Millimeters	[]	- Metric numbers
		{}	- 1,000 sq. ft. numbers

## METER CAL CONVERSIONS

To convert the METER CAL number simply divide the original number (number printed on Flow Meter label) by the desired conversion factor.

### FOR EXAMPLE:

$$\frac{\text{Original METER CAL No.}}{128} = \text{METER CAL No. for displays in Fluid Ounces}$$

$$\frac{\text{Original METER CAL No.}}{3.785} = \text{METER CAL No. for displays in Liters}$$

$$\frac{\text{Original METER CAL No.}}{\text{Weight of one gallon}} = \text{METER CAL No. for displays in Pounds}$$

## LIQUID CONVERSIONS

U.S. Gallons x 128 = Fluid Ounces  
U.S. Gallons x 3.785 = Liters  
U.S. Gallons x 0.83267 = Imperial Gallons  
U.S. Gallons x 8.34 = Pounds (Water)

## LENGTH

1 millimeter (mm) = 0.039 inch  
1 centimeter (cm) = 0.393 inch  
1 meter (m) = 3.281 feet  
1 kilometer (km) = 0.621 mile  
1 inch = 25.4 millimeters; 2.54 centimeters  
1 mile = 1.609 kilometers

## PRESSURE

1 psi = 6.89 kPa

## AREA

1 square meter = 10.764 square feet  
1 hectare (ha) = 2.471 acres; 10,000 square meters  
1 acre = 0.405 hectare; 43,560 square feet  
1 square mile = 640 acres; 258.9 hectares

# INTRODUCTION

The Raven SCS 330 (SPRAYER CONTROL SYSTEM) is designed to improve the uniformity of spray applications automatically. Its performance relies on the installation and preventive maintenance of the complete sprayer. It is important that this Installation and Service Manual be reviewed thoroughly before operating the system. This Manual provides a simple step-by-step procedure for installing and operating.

The SCS 330 consists of a computer based Control Console, a Speed Sensor, a turbine type Flow Meter, and a motorized Control Valve. The Console mounts directly in the cab of the vehicle for easy operator use. The Raven Radar Speed Sensor is mounted on the vehicle or on the sprayer implement (Speedometer Drive Speed Sensors and Wheel Drive Speed Sensors are also available). The motorized Control Valve and Flow Meter mount directly to the framework of the sprayer. Appropriate cabling is furnished for field installation.

The operator sets the target rate (volume per area) to be sprayed and the SCS 330 automatically maintains the flow regardless of vehicle speed or gear selection (within range of selected spray nozzles). A manual override switch allows the operator to manually control flow for system check-out and spot spraying. The SCS 330 additionally functions as an area monitor, speed monitor, and volume totalizer.

# INSTALLATION

## 1. MOUNTING THE RAVEN RADAR SPEED SENSOR

See Appendix 1 for Wheel Drive Speed Sensor installation instructions.

See Appendix 2 for Speedometer Drive Speed Sensor installation instructions.

For mounting the Radar, the following guidelines will assure proper installation:  
It is suggested that a large heavy mounting bracket, (P/N 107-0159-693) be attached to the vehicle frame for mounting the Radar.

- 1) Park vehicle on level surface.
- 2) Select mounting site by considering the following:
  - a) The line of sight from the lens to the ground must not be obstructed by structures or tires. Obstructions must not come closer than 20 inches to the bottom of the Radar. See Figures 1 and 2.
  - b) The Radar lens must be parallel to the ground from front to back. Radar can be tilted out 0-15 degrees to provide more clearance and miss obstructions. See Figure 2.
  - c) The Radar should be mounted so that the **length** of the Radar is **parallel** with direction of vehicle travel.
- 3) Use carpenters level to verify that mounting bracket is parallel to the ground.
- 4) Bolt mounting bracket to implement.
- 5) Bolt Radar to mounting bracket using mounting hardware. See Figure 3.
- 6) Connect Radar with Radar Interface Cable (P/N 115-0159-539), to the Console. The Red wire should be connected to the Orange cable wire. The White wire should be connected to the White cable wire (See "BATTERY CONNECTIONS").

**CAUTION:** The connection of the Radar power in reverse polarity could result in damage to the Radar.

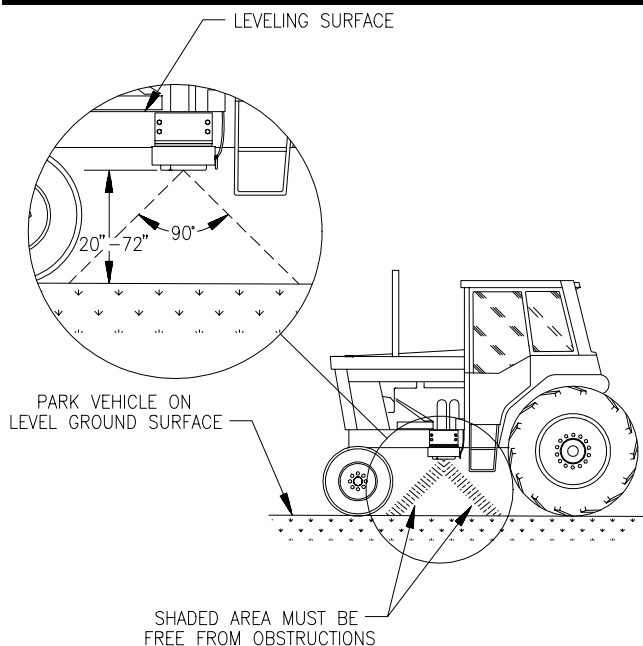

FIGURE 1

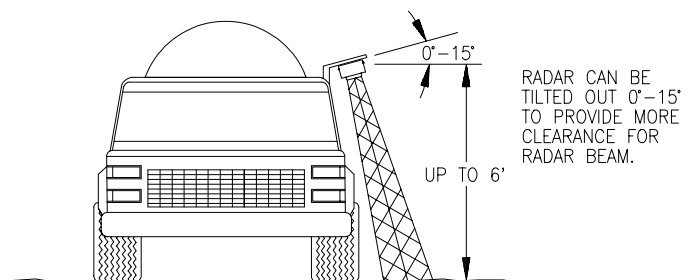

FIGURE 2

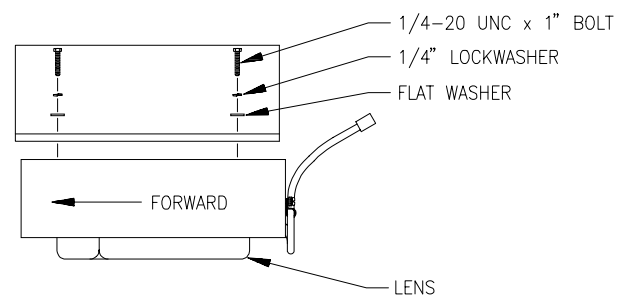
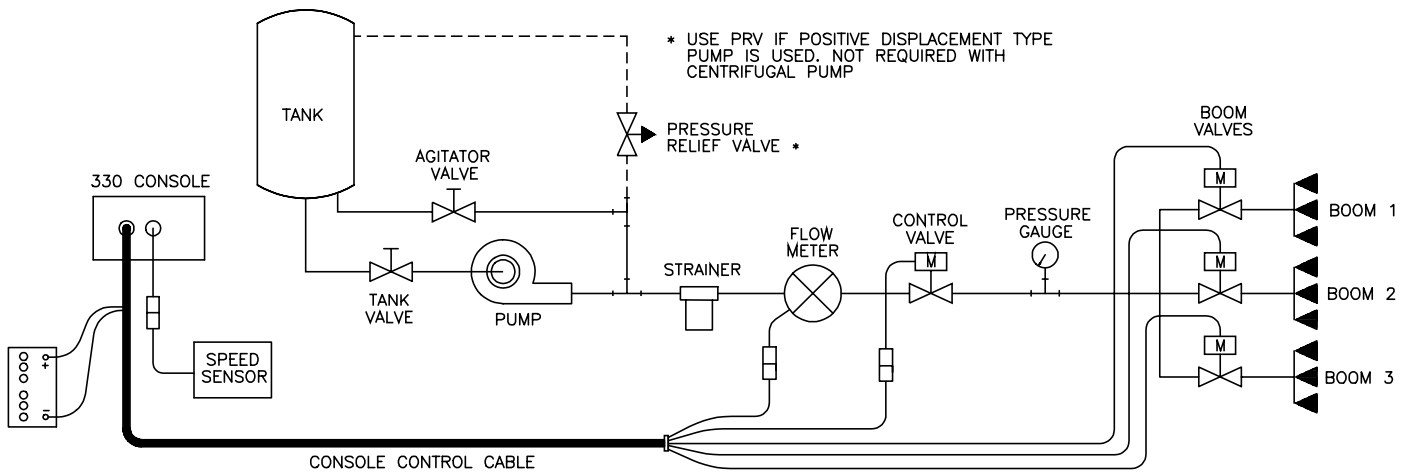

FIGURE 3

## 2. MOUNTING THE FLOW METER

- 1) Mount the Flow Meter in the area of the boom valves per Figure 4. All flow through the Flow Meter must go to booms only, i.e. no return line to tank or pump after Flow Meter.
- 2) Mount Flow Meter horizontal to the ground. Use the bracket to secure the Flow Meter.
- 3) For best results, allow a minimum of 7 1/2 inches [20 cm] of straight hose on inlet of Flow Meter. Bend radius of hose on outlet of Flow Meter should be gradual.
- 4) Flow must be in direction of arrow on Flow Meter.

**NOTE:** For flow rates less than 3 GPM [11 lit/min], mount the Flow Meter vertically with arrow pointing upward. (Refer to Appendix 3 for alternate plumbing diagram).



**FIGURE 4**

**NOTE:** It is essential, when using suspensions, that the system be thoroughly rinsed out each day after use. Failure to do so may cause system to malfunction.

## 3. MOUNTING THE CONTROL VALVE

- 1) Mount the motorized Control Valve in the main hose line between the Flow Meter and the booms, with motor in the upright position. (For less than 3 GPM [11 lit/min] the motorized Control Valve is mounted in the by-pass line, refer to Appendix 3 for alternate plumbing diagram).
- 2) Connect the Flow Control Cable connectors to boom valves, Flow Meter, and motorized Control Valve. (Black wire to boom valve #1, Brown wire to boom valve #2, and Blue wire to boom valve #3).

## 4. MOUNTING THE CONSOLE AND CABLING

- 1) Mount the Console to secure support inside the cab of the vehicle.
- 2) Connect the Control Cable to the plug in the back of the Console. Route the cable out of the vehicle cab. (Flow Meter extension cables are available from your Dealer).

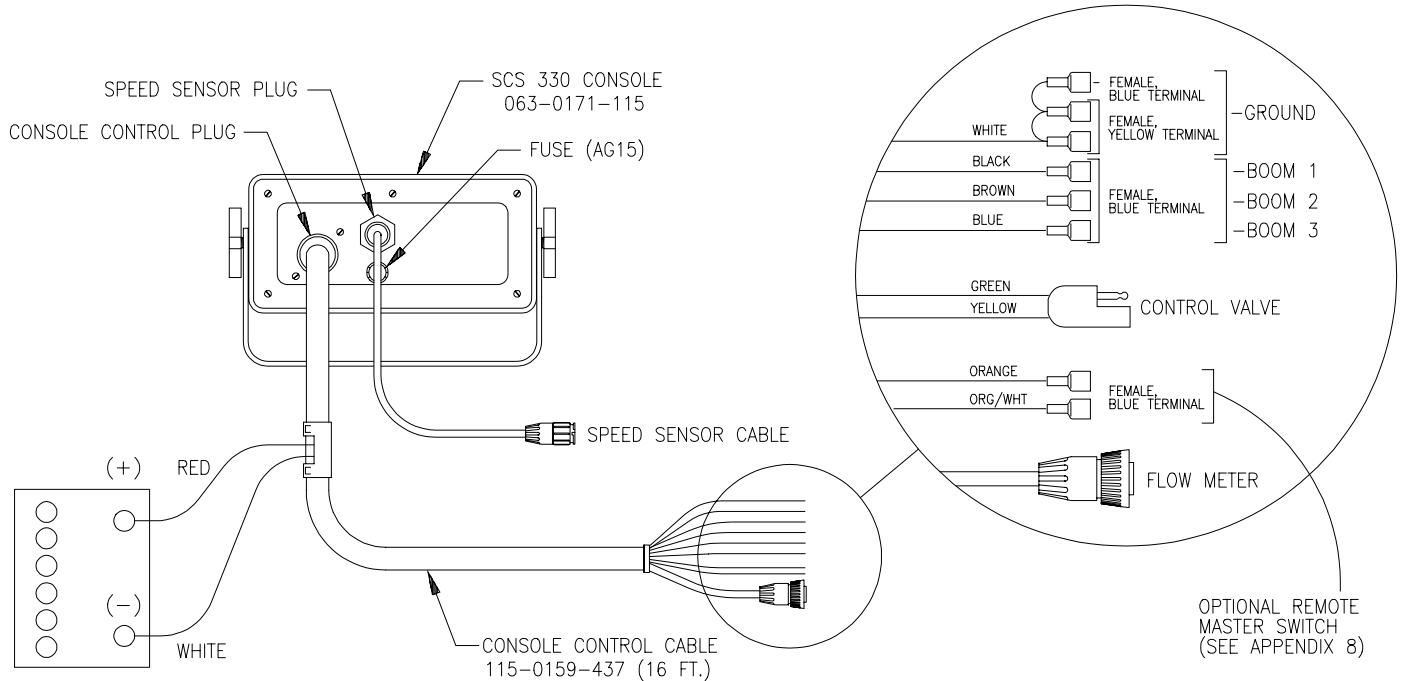
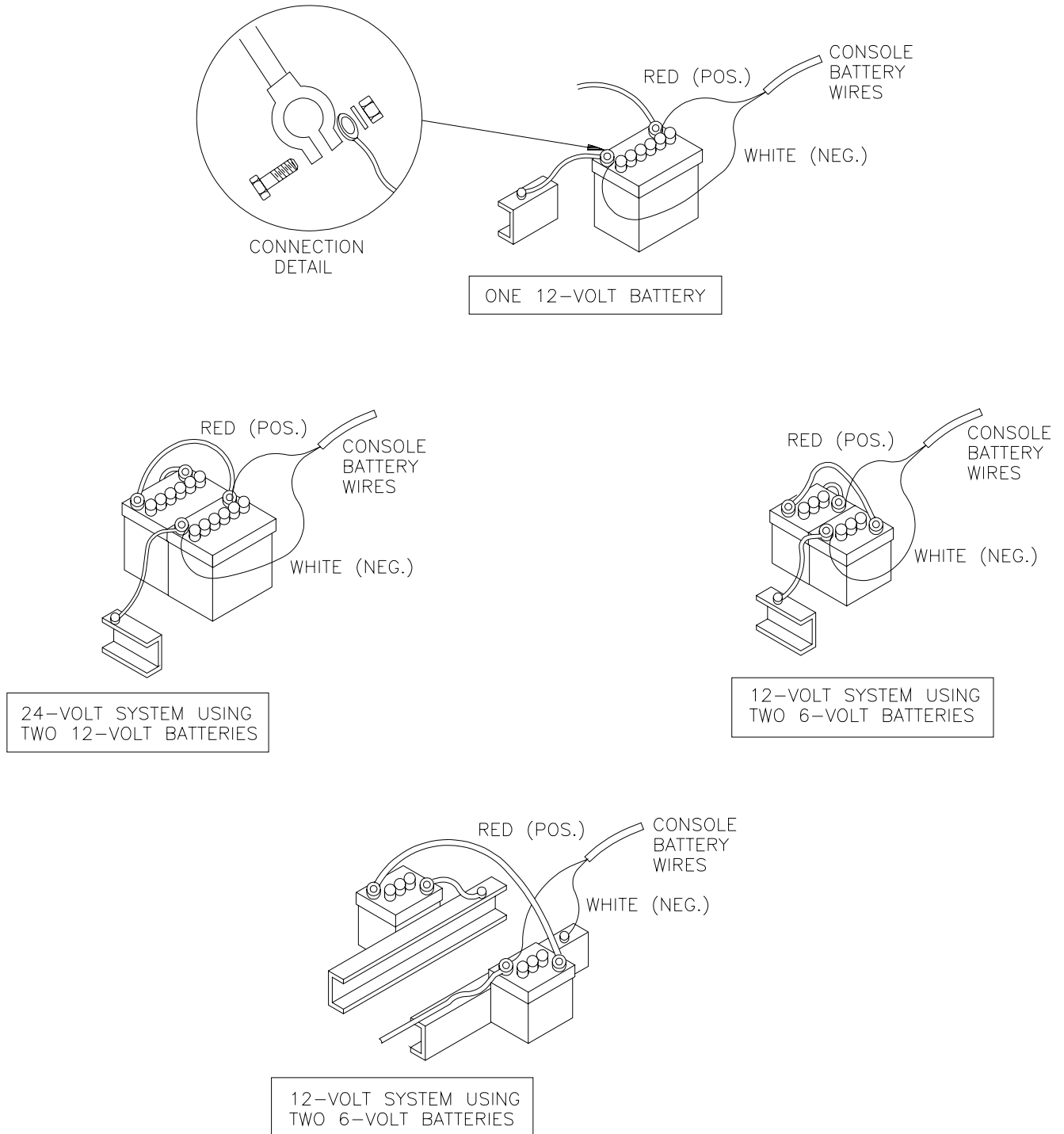

FIGURE 5

- 3) Turn AUTO/MAN/OFF switch OFF and route Red and White battery wires to a 12-Volt battery. Attach White battery wire to the **NEGATIVE** (-) battery terminal, and the Red battery wire directly to the **POSITIVE** (+) battery terminal. See Figure 6 on page 7. **(DO NOT CONNECT RED AND WHITE WIRES TO THE STARTER)**. Secure the battery wires with plastic cable ties. **DO NOT** tie battery wires close to existing battery leads or any other electrical wiring. See Appendix 8 for Remote Switch installation.
- 4) Connect the Speed Sensor to the plug in the back of the Console.
- 5) Secure and tie the Speed Sensor Cable and Console Control Cable with plastic cable ties.
- 6) Initial installation of the system is now complete.



# BATTERY CONNECTIONS



**FIGURE 6**

# CONSOLE FEATURES

**IMPORTANT:** This Console requires selection of **US** (acres), **SI** [hectares], or **TU** {1,000 sq. ft.} area; **SP1** (wheel drive, etc.) or **SP2** (radar) speed sensor; and **C-sd** (Standard Valve) or **C-FC** (Fast Close Valve).

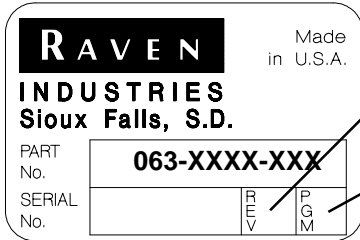

Console Revision can be determined by the letter stamped in REV box on label.

Console Program can be determined by the letter stamped in PGM box on label.

Manual override control provides capability for spot spraying.

Booms can be controlled individually, or all at once with MASTER ON/OFF switch.

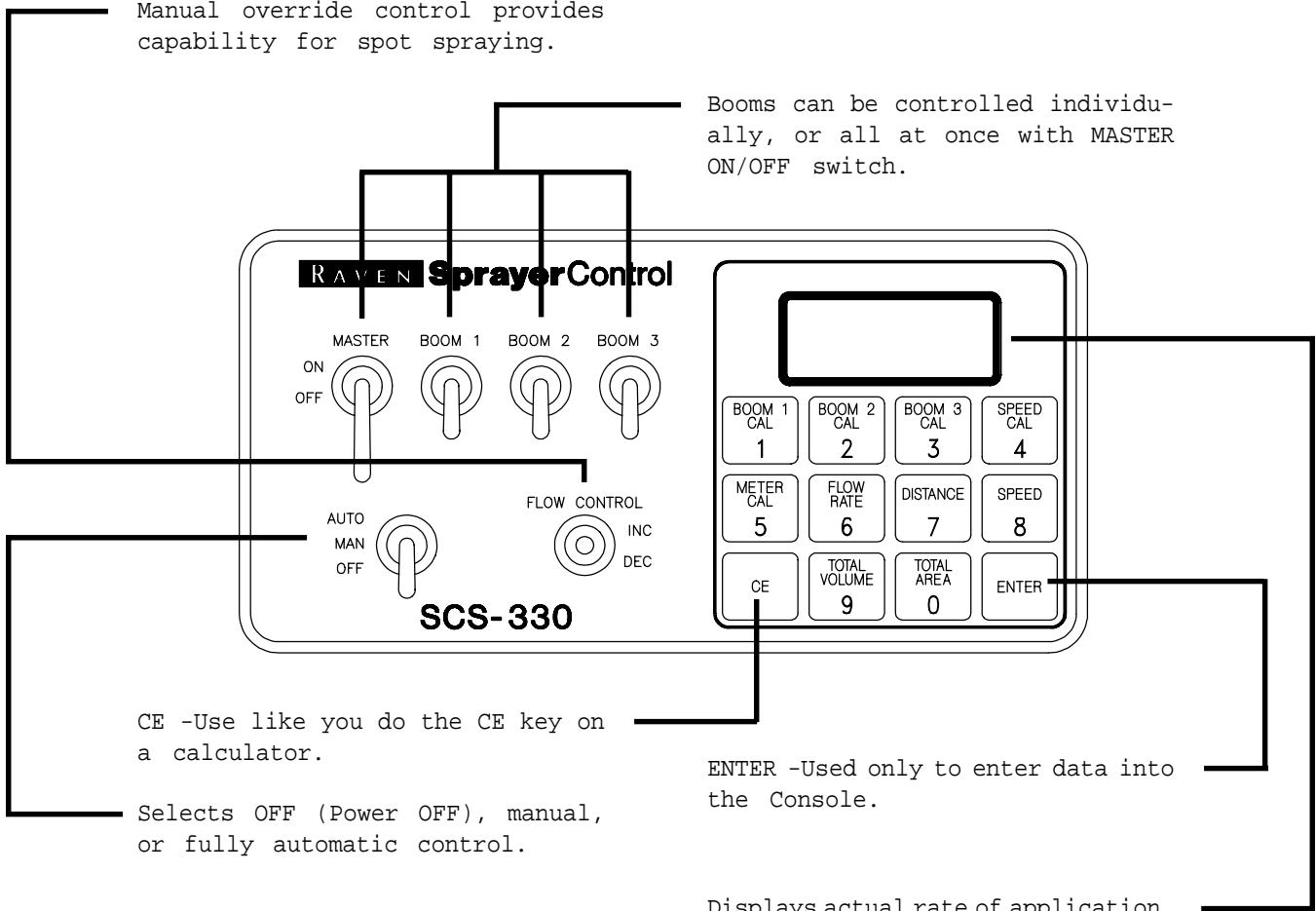

CALIBRATION KEYS -- Used to enter data into the Console to calibrate the system.

FUNCTION KEYS -- Used to Display Data

- BOOM 1 CAL -- Length of Boom 1
- BOOM 2 CAL -- Length of BOOM 2
- BOOM 3 CAL -- Length of BOOM 3
- SPEED CAL -- Determined by Speed Sensor
- METER CAL -- Meter Calibration Number
- FLOW RATE -- Target Application Rate

- DISTANCE -- Distance Traveled
- SPEED -- Speed of Vehicle
- TOTAL VOLUME -- Total Volume Applied
- TOTAL AREA -- Total Area Applied

# CONSOLE CALIBRATION

## 1. CALCULATING "BOOM CAL"

### 1) Broadcast Spraying:

Calculate the width of each boom in inches [cm] by multiplying the number of tips times the spacing. Write these boom widths down for future reference when programming the Console.

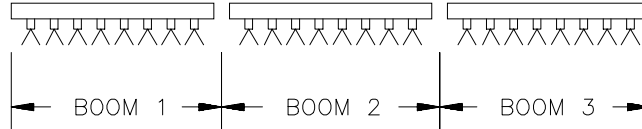

FIGURE 7

### 2) Band Spraying:



Calculate the width of each boom in inches [cm] by multiplying the number of tips by the spacing. Calculate the Adjusted Applied Rate by multiplying the Broadcast Rate by Band Width in inches [cm] divided by Spacing in inches [cm].

**EXAMPLE:** Broadcast Rate = 20 GPA [200 lit/ha]  
Spacing = 40 inches [100 cm]  
Band Width = 14 inches [40 cm]

$$\begin{aligned} \text{Adjusted Applied Rate} &= \frac{\text{GPA} \times \text{Band Width}}{\text{Spacing}} \\ &= \frac{20 \times 14}{40} = 7 \text{ GPA} \\ &= \frac{[200] \times [40]}{[100]} = [80 \text{ lit/ha}] \end{aligned}$$

## 2. CALCULATION OF RADAR "SPEED CAL"

**NOTE:** Numbers in brackets [ ] are metric equivalents.

- 1) Reset Console according to the instruction manual.
- 2) Complete "INITIAL CONSOLE PROGRAMMING" in the Installation and Service Manual for your Console. Select SP2 for correct operation of radar. If your Console does not have SP1/SP2 select, you must either update your Console's program, or use a radar adapter (P/N 063-0159-590).
- 3) Enter a SPEED CAL number of 598 [152] in key labelled  .
- 4) Set POWER switches to ON, all other switches to OFF.
- 5) Enter "0" in key labelled  .
- 6) Drive 1 mile [1 kilometer]. To achieve the most accurate calibration, accelerate and decelerate slowly.

**CAUTION:** Do not use vehicle odometer to determine distance. Use section lines or highway markers.

- 7) Read DISTANCE by depressing key labelled  .

DISTANCE display should read a value of approximately 5280 [1000]. If it reads between 5260-5300 [990-1010], the SPEED CAL is 598 [1520].

If the DISTANCE display reads any other value, divide SPEED CAL by the value observed in DISTANCE, then multiply by 5280 [1000]. This will give you the correct value to enter for SPEED CAL. Round off to the nearest 3 digit number.

**EXAMPLE:** Assume DISTANCE reads 5000 [980].

$$\begin{aligned} \text{ENGLISH UNITS:} \\ &= \frac{598 \times 5280}{5000} = 631.5 \end{aligned}$$

$$\begin{aligned} \text{METRIC UNITS:} \\ &= \frac{[1520] \times [1000]}{[980]} = [1550] \end{aligned}$$

The number to enter for SPEED CAL is 632 [155].

- 8) Recheck the new SPEED CAL calculated in Step 7 as follows:
  - a) Enter the new SPEED CAL number as in Step 3.
  - b) Repeat Steps 5, 6, and 7.



## 5. CALCULATING "RATE CAL"

Determine the application rate at which your chemical should be sprayed. Consult with your Dealer to ensure your spray nozzles are capable of applying at this rate. In determining which spray nozzles to use with your sprayer, you must know:

- 1) Nominal Application Pressure                    \_\_\_ PSI [kpa]
- 2) Target Application Rate                        \_\_\_ GPA [lit/ha]
- 3) Target Speed                                     \_\_\_ MPH [km/h]
- 4) Nozzle Spacing                                 \_\_\_ inches [cm]

From this information, calculate the volume per minute, per nozzle as follows:

$$\text{GPM [lit/min]} = \frac{\text{GPA [lit/ha]} \times \text{MPH [km/h]} \times \text{inches [cm]}}{5,940 [60,000]}$$

- EXAMPLE:**
- 1) Application Pressure                         = 30 PSI
  - 2) Target Application Rate                      = 20 GPA
  - 3) Target Speed                                  = 5.2 MPH
  - 4) Nozzle Spacing                               = 20 inches

$$\text{GPM} = \frac{20 \text{ GPA} \times 5.2 \text{ MPH} \times 20 \text{ inches}}{5,940} = .35$$

Using GPM .35 and pressure 30 you would select tip number XR8004 from the chart below, since it comes closest to providing the desired output.

TIP COLOR	TIP NO.		LIQUID PRESSURE IN PSI	CAPACITY 1 NOZZLE IN GPM	CAPACITY 1 NOZZLE IN OZ./MIN.	GALLONS PER ACRE 20" SPACING			
	80 DEG.	110 DEG.				5 MPH	6 MPH	7 MPH	8 MPH
YELLOW	XR8002	XR11002	15	.12	15	7.3	6.1	5.2	4.5
			20	.14	18	8.4	7.0	6.0	5.3
			30	.17	22	10.3	8.6	7.4	6.4
			40	.20	26	11.9	9.9	8.5	7.4
			60	.25	32	14.6	12.1	10.4	9.1
BLUE	XR8003	XR11003	15	.18	23	10.9	9.1	7.8	6.8
			20	.21	27	12.6	10.5	9.0	7.9
			30	.26	33	15.4	12.9	11.0	9.7
			40	.30	38	17.8	14.9	12.7	11.1
			60	.37	47	22.0	18.2	15.6	13.6
RED	XR8004	XR11004	15	.24	31	14.5	12.1	10.4	9.1
			20	.28	36	16.8	14.0	12.0	10.5
			30	.35	45	21.0	17.2	14.7	12.9
			40	.40	51	24.0	19.8	17.0	14.9
			60	.49	63	29.0	24.0	21.0	18.2
BROWN	XR8005	XR11005	15	.31	40	18.2	15.2	13.0	11.4
			20	.35	45	21.0	17.5	15.0	13.1
			30	.43	55	26.0	21.0	18.4	16.1
			40	.50	64	30.0	25.0	21.0	18.6
			60	.61	78	36.0	30.0	26.0	23.0

### VERIFYING FLOW RATE LIMITS:

The flow rate of spraying must be within the range of that specified for the Flow Meter included.

#### FLOW METER MODEL

RFM 5  
 RFM 15  
 RFM 55/55A  
 RFM 100  
 RFM 200/200 Poly  
 RFM 400

#### FLOW RANGE

0.05-5 GPM [0.2-18.9 lit/min]  
 0.3-15 GPM [1.1-56.8 lit/min]  
 1-55 GPM [3.8-208 lit/min]  
 3-100 GPM [11.4-379 lit/min]  
 15-200 GPM [56.8-757 lit/min]  
 25-400 GPM [94.6-1514 lit/min]

# CONSOLE PROGRAMMING

When entering data into the Console, the entry sequence is always the same.

NOTE: DATA MUST BE ENTERED INTO KEYS 1 THRU 6.

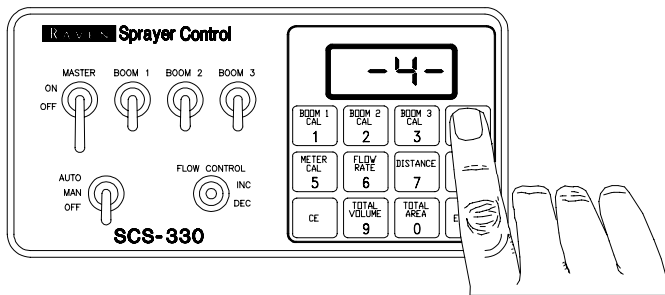

Depress the key in which you wish to enter data.

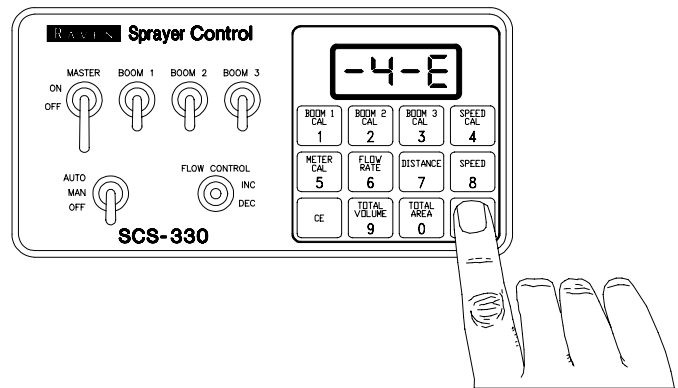

Depress the ENTER key. An "E" will illuminate in the DATA display.

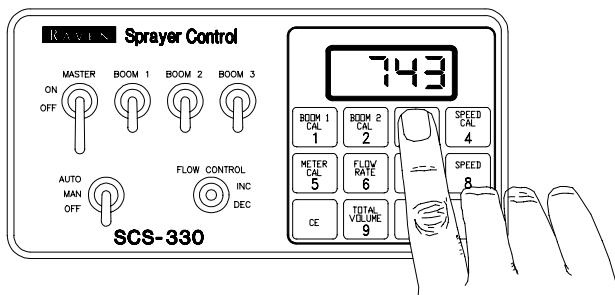

Depress the keys corresponding to the number you wish to enter (i.e. "7", "4", "3"). The numbers will be displayed as they are entered.

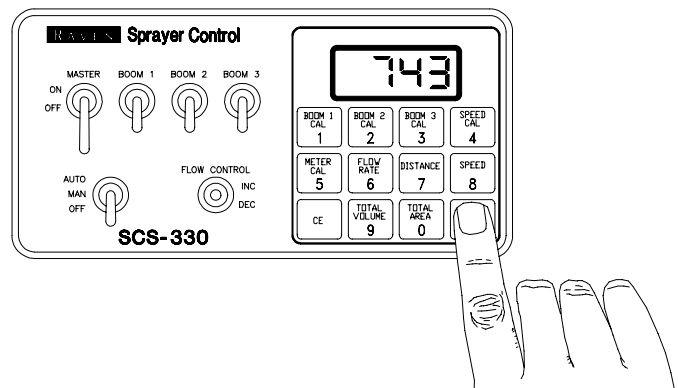

Complete the entry by again depressing the ENTER key.

# 1. INITIAL CONSOLE PROGRAMMING

When you first turn on Console power after all installation procedures have been completed, the Console will display "US" in the display window. This means you must "calibrate", or program, the Console before it can be operated. This is a one-time operation which does not have to be repeated. Turning OFF the power switch does not affect the Console memory. All data is retained.

**IMPORTANT:** If an entry selection error is made during Steps 1-6, place the AUTO/MAN/OFF switch to the OFF position. Depress the  key and hold while placing the AUTO/MAN/OFF switch to AUTO or MAN. This will "reset" the Console.

The following steps must be followed:

- 1) Display US (acres), SI [hectares], or TU {1000 sq. ft.}.
  - a) Depressing momentarily  steps the display from US to SI.
  - b) Depressing momentarily  steps the display from SI to TU.
  - c) Depressing momentarily  steps the display from TU to US.
- 2) Selecting US, SI, or TU.
  - a) To select US, SI, or TU, step  until the desired code is displayed.
  - b) Momentarily depress . The display will now display SP1.
- 3) Display SP1 (wheel drives, etc.) or SP2 (radar).
  - a) Depressing momentarily  steps the display from SP1 to SP2.
  - b) Depressing momentarily  steps the display from SP2 to SP1.
- 4) Selecting SP1 or SP2.
  - a) To select SP1 or SP2, step with  until desired code is displayed.
  - b) Momentarily depress . The display will now display C-Sd.



- 5) Display C-Sd (Standard Valve), or C-FC (Fast Close Valve).
- a) Depressing momentarily  steps the display from C-Sd to C-FC.
- b) Depressing momentarily  steps the display from C-FC to C-Sd.
- 6) Selecting C-Sd or C-FC.
- a) To select C-Sd or C-FC, step  until desired code is displayed.
- b) Momentarily depress , the display will now show "CAL".
- 7) Enter BOOM 1 CAL calibration number in inches [cm] in key labelled  .
- 8) Enter BOOM 2 CAL calibration number in inches [cm] in key labelled  .
- If there is only 1 boom used , you must enter "0" for BOOM 2 CAL.
- 9) Enter BOOM 3 CAL calibration number in inches [cm] in key labelled  .
- If there is only 1 or 2 booms used, you must enter "0" for BOOM 3 CAL.
- 10) Enter SPEED CAL calibration number inches [dm] in in key labelled  .
- 11) Enter METER CAL calibration number in key labelled  .
- 12) A VALVE CAL calibration number is automatically entered into the console based on what your valve selection was during the initial Console programming settings (C-Sd=2123 and C-FC=743). To change the VALVE CAL setting, depress key labelled  for 5 seconds. The display will show the current VALVE CAL calibration number. Enter a new VALVE CAL calibration number if desired.
- 13) Enter the FLOW RATE target application rate in GPA [lit/ha]{GPK} in key labelled  .









**NOTE:** A decimal point is displayed automatically. Therefore, twenty gallons per acre is entered as 20.0, not 2.0.

**YOU HAVE NOW COMPLETED PROGRAMMING THE CONSOLE**

The display of "CAL" will now extinguish and the Console will begin to display data. If not, repeat procedure starting at Step 7.

## 2. OTHER DISPLAY FEATURES

See Appendix 9 for detailed outline of each Console key and what features are located under them.

- 1)** To display the set operating modes for units of measure (US, SI, TU), speed sensor type (SP1, SP2), and valve type (C-Sd, C-FC), depress  for 5 seconds and continue holding. DATA display will toggle thru selections until key is released.
- 2)** To display TOTAL AREA covered, depress key labelled  .  
To "zero out" this total at any time, enter a "0" in this key.
- 3)** To display TOTAL VOLUME sprayed, depress key labelled  .  
To "zero out" this total at any time, enter a "0" in this key.
- 4)** To display speed in MPH [km/h], depress key labelled  .
- 5)** To display DISTANCE in feet [m] traveled, depress key labelled  .  
To "zero out" this total at any time, enter a "0" in this key.
- 6)** To display actual application flow rate in GAL/MIN [li/min], place MASTER switch in ON position and depress key labelled  .  
To display target application flow rate, place MASTER switch to OFF and depress key labelled  .  
To display the volume/minute being applied, depress key labelled  for 5 seconds.
- 7)** To display current VALVE CAL setting, depress key labelled  for 5 seconds.  
VALVE CAL number will show in DATA display.
- 8)** To view any of the set calibration numbers, depress the corresponding calibration keys.

### 3. SELF TEST FEATURE

SELF TEST allows speed simulation for testing the system while the vehicle is not moving. Enter the simulated operating speed by depressing the key labelled



for 5 seconds. Display will show "-tEst-". If 6 MPH [9.6 km/h] is desired,

enter 6.0 [9.6] (See CONSOLE PROGRAMMING). Verify SPEED by depressing key

labelled . The display will show 6.0 [9.6]. The SELF TEST speed will clear

itself when motion of vehicle is detected by the Speed Sensor. A SPEED CAL value of 900 [230] or greater is recommended when operating in this mode.

**NOTE:** To prevent nuisance clearing of self-test speed, disconnect speed connector on back of the Console when Radar Speed Sensors are used.

### 4. ALARM MENU

1) To display ALARM MENU, depress key labelled  for 5 seconds. "A on" will show in the DATA display.

a) Momentarily depressing  toggles the display between "A on" and "Aoff".

"A on" means alarm is enabled, "A off" means alarm is disabled.

### 5. OFF TARGET ALARM

Alarm sounds when the actual rate is off from the target rate by a specified percentage. The Off Target value is preset to 30%, but may be changed to a different number.

1) Adjusting Off Target value.

a) Depress  for 5 seconds. Display will show "or". Enter desired new number for OFF TARGET ALARM.

b) Depress  to store selection.

## 6. AUTOMATIC RATE +/-

This feature sets the increment at which flow is increased or decreased in the AUTO mode of operation. Select RATE +/- for product by depressing  for 7 seconds. The display will show "dELt". Enter the desired amount for +/-.

**EXAMPLE:** If flow rate is to be changed by "1.0":  
Enter a value of 1.0 for RATE +/- . When in AUTO, each time the INC/DEC switch is positioned to INC the flow rate CAL for that product will increase by "1.0". Likewise, when positioned to DEC the flow rate CAL will decrease by "1.0".

## 7. LOW LIMIT FLOW SET POINT AND LOW LIMIT ALARM

1) To display low limit flow set point depress key labelled  for 9 seconds.

Display will show "LL" and low limit flow rate will appear in the display. A low limit flow rate may now be entered.

2) If the actual volume per minute falls below the set limit the Control Valve stops closing, an alarm sounds (if enabled) and the display flashes "-LL-".

3) The low limit value should be determined with all booms ON. This value is automatically proportioned to the percentage of booms that are ON.

**EXAMPLE:** If the entered low limit is 4, and half the total boom length is shut OFF, the Console will automatically reduce the low limit flow set point to 2.

## 8. DISPLAY SMOOTHING

Turns display smoothing ON or OFF. Selecting display smoothing ON means the display window will show the target rate if the actual rate is within 10% of the target rate.

1) To show DISPLAY SMOOTHING, depress key labelled  for 7 seconds. "d on" will show in the display.

a) Momentarily depressing  toggles the display between "d on" and "doff".

"d on" means display smoothing is enabled, "doff" means display smoothing is disabled.

## 9. VALVE CAL

To display current VALVE CAL setting, depress key labeled  for 5 seconds. VALVE CAL number will show in DATA display.

## 10. CONTROL VALVE DELAY

Depress key labelled  for 5 seconds. "dLAY" will be displayed.

 Control Valve Delay Digit

The Control Valve Delay number is a 4 digit number. The first digit in the Control Valve Delay number represents the time (in seconds) between when the booms are turned ON and when the Console actually begins to control the flow rate. A value of 1-9 means a delay of 1-9 seconds respectively, a value of 0 means no delay. The remaining 3 digits are always zero. The Control Valve Delay feature only operates when the booms are toggled OFF or ON in intervals of 30 seconds or less.

## 11. SEQUENCE TO ACTIVATE DATA-LOCK

The DATA-LOCK feature prohibits the entry of data without first entering an activated code number. The code number may be up to 4 digits long. The code number may be cleared by changing the activated code from its existing number to "0", or by resetting the Console (SEE INITIAL CONSOLE PROGRAMMING).

**NOTE:** If the DATA-LOCK feature is not desired, skip Step 10.

- 1) Depress  for 5 seconds, a new code indicator message of "nEu.l " will appear.
- 2) Enter a desired number code within 15 seconds.



**EXAMPLE:** For code number 1234: Depress     and  .

## 12. SEQUENCE TO CHANGE DATA-LOCK

- 1) Depress  for 5 seconds, an old code indicator message of "oLd " will appear.
- 2) Enter the existing number code within 15 seconds.
- 3) A new code indicator message of "nEu.l " will appear.
- 4) Enter the new number code within 15 seconds.

**EXAMPLE:** For code number 4321: Depress     and  .

## 13. ENTER MODE SEQUENCE WITH ACTIVATED DATA-LOCK

- 1) Depress the Console key that you wish to enter data into and depress  .
- 2) "codE" message will appear in the display. Enter your activated code number and depress  . If code is correct, "E" will appear in display and Console will allow data entry, If code is incorrect, Console will cancel out of requested key.

## INITIAL SYSTEM SET-UP

- 1) Fill tank with water only. (If positive displacement pump is used, fully open pressure relief valve, PRV).
  - 2) Place MASTER ON/OFF switch to ON and BOOM ON/OFF switches to OFF.
  - 3) Place AUTO/MAN/OFF switch to MAN.
  - 4) Verify that Boom Widths, SPEED CAL, METER CAL, and RATE CAL have been entered correctly into the Console. In SELF TEST mode enter the normal sprayer operating speed.
  - 5) Run pump at normal operating RPM.
  - 6) If centrifugal pump is used, proceed with Step 8. If positive displacement pump is used, set pressure relief valve (PRV) to 65 PSI [450 kPa].
  - 7) Verify that boom valves operate and that no nozzles are plugged by operating the individual BOOM ON/OFF switches.
  - 8) Place all BOOM ON/OFF switches to ON.
  - 9) Hold the FLOW CONTROL switch in INC position until pressure is at its maximum. This assures that the motorized Control Valve is fully open. Verify maximum pressure and RATE. (Pressure gauge is not supplied with the system).
- NOTE:** A pressure gauge MUST be installed to properly monitor the system.
- 10) Adjust agitator line hand valve for desired agitation. Verify maximum pressure is still present.
  - 11) Hold the FLOW CONTROL switch to DEC position until pressure is at its minimum. This assures that the motorized Control Valve is fully closed. Verify minimum pressure and RATE. If minimum pressure and RATE can not be obtained, consider by-pass plumbing system in Appendix 3.

# INITIAL SYSTEM FIELD TEST

- 1) Drive down field or road at target speed with sprayer booms OFF, to verify SPEED readout on Console.
- 2) Turn MASTER switch and BOOM switches to ON. Place the OFF/MAN/AUTO switch to AUTO. Increase or decrease speed by one MPH [2 km/h]. The system should automatically correct to the target application rate.
- 3) If for any reason, the system is unable to correct to the desired RATE, check for an empty tank, a plugged line, a malfunctioning pump, improper vehicle speed, or a defect in the system.
- 4) If the system does not appear to be correcting properly, first review INITIAL SYSTEM SET-UP, then refer to SERVICE MANUAL and TROUBLESHOOTING GUIDE.
- 5) At the end of each row, place the MASTER switch to OFF to shut off flow. This also shuts off the area totalizer.
- 6) Verify area covered and volume used.

# PREVENTIVE MAINTENANCE

Preventive maintenance is most important to assure long life of the system. The following maintenance procedures should be followed on a regular basis:

- 1) Flush entire system with water after use of suspension type chemicals. Failure to clean system can result in crystallization of chemicals which may plug the Flow Meter, lines, and/or tips.
- 2) Flush and drain Sprayer before storing. **FREEZING TEMPERATURES MAY DAMAGE FLOW METER IF WATER IS NOT DRAINED.**
- 3) Remove Flow Meter at the end of each spraying season. Clean Flow Meter turbine and inlet hub. Clean off all metal filings and wettable powders which have hardened on the plastic and metal parts. Check the inlet hub and turbine assembly for worn or damaged turbine blades and bearings. Flush Flow Meter with clear water and drain.

**KEEP FROM FREEZING**

- 4) Remove Console when not in use for extended periods.

# APPENDIX 1

## WHEEL DRIVE SPEED SENSOR INSTALLATION AND CALIBRATION PROCEDURE

### 1. MOUNTING WHEEL DRIVE SPEED SENSOR

The Wheel Drive Speed Sensor consists of two magnets, a switch assembly with cable, and mounting hardware.

Sequence of mounting Speed Sensor:

- 1) Select a non-driven wheel (left front tractor wheel or implement wheel).
- 2) Check for predrilled holes in rim. If not predrilled, see "RIM DRILLING INSTRUCTIONS FOR WHEEL DRIVE SPEED SENSOR".
- 3) Mount the two magnets to the inside of rim and tighten (See Figures below). Magnets must be mounted in alternating red-black order.
- 4) Mount switch assembly to stationary column with the hardware provided (See below). The switch assembly need not pivot with the wheel.

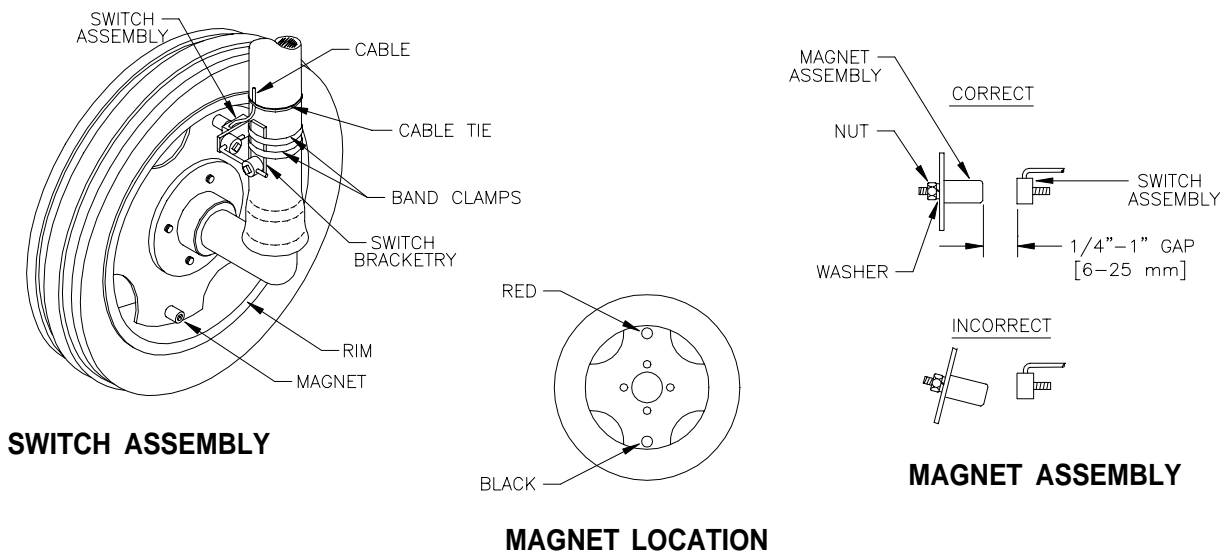

- 5) Position switch assembly so that as the wheel rotates the magnets pass across the center of the black, molded switch assembly.
- 6) Clearance gap between magnets and switch assembly must be between 1/4 inch [6 mm] and 1 inch [25 mm]. With wheels pointed straight ahead, rotate wheel to ensure gap is correct. Make sure vehicle wheels can be turned to their extremes in each direction without the magnets hitting the switch assembly.
- 7) Tighten switch assembly bracketry.
- 8) Secure cable to column with plastic cable ties.



## 2. RIM DRILLING INSTRUCTIONS FOR WHEEL DRIVE SPEED SENSOR MAGNETS

On wheels which do not have pre-punched mounting holes, proceed as follows:

**NOTE:** If only two magnets are to be mounted; drill two holes 180° from each other.

### RIMS WITH A FOUR OR EIGHT HOLE STUD PATTERNS:

Choose stud holes that are opposite each other as shown below. Using the center of opposite holes, scribe two lines on the rim web to divide the circumference into four equal parts. Measure in one inch from the outer edge of the web on each of the lines drawn. Mark this point as the center. Drill four 1/2" holes for mounting the magnets.

### RIMS WITH A SIX HOLE STUD PATTERN:

Locate the center of the holes to be drilled by using the rim webbing as a guide. Obtain a small piece of wood and cut to fit exactly over the web as shown. Measure the length of the piece of wood and mark the center on one edge. Using the center mark on the piece of wood, mark each of the four webs. Measure in one inch from the outer edge of the web on each of the lines drawn. Mark this point as center and drill four 1/2" holes for mounting the magnets.

**NOTE:** Distance (D) between each set of drilled holes must be equal within 1/8" [3 mm] to ensure accuracy of system.

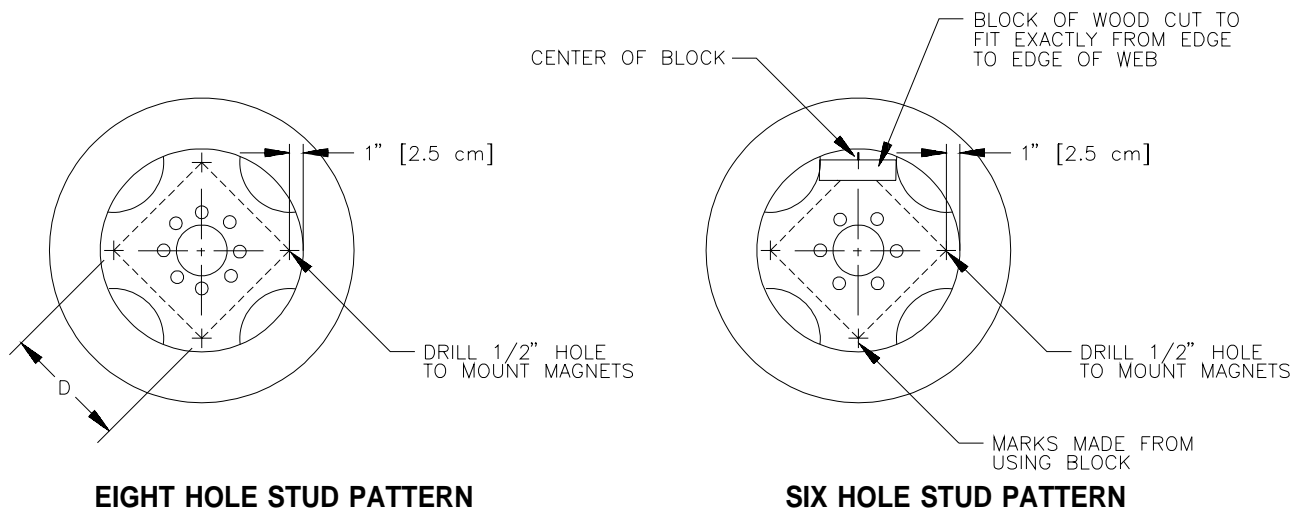

### 3. CALCULATING "SPEED CAL"

- 1) Place a chalk mark or tape onto the vehicle tire that the Speed Sensor mounted to it as shown below.
- 2) Mark the initial spot on the ground.
- 3) Drive vehicle straight ahead counting 10 full revolutions of the wheel. The mark must stop at the same position it was in when the vehicle started.
- 4) Measure the distance from the ground starting mark to stopping mark in inches [dm] (Round off fractions).
- 5) Write down this distance as the SPEED CAL number; keep it for future reference when programming the Console.

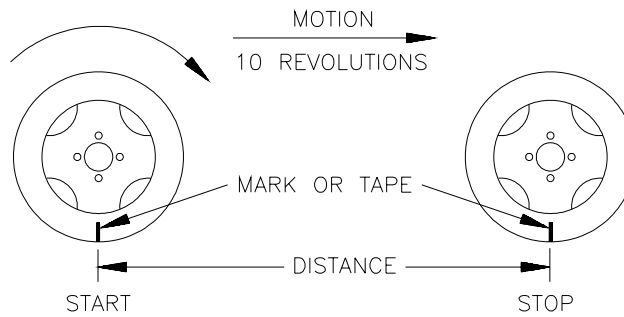

**NOTE:** This measurement is critical to the performance of the Console. **MEASURE CAREFULLY.** Be sure tire is properly inflated before measuring. Measure tire in type of soil in which you will be spraying. Circumference of tire will vary when measured in soft soil versus hard packed soil. For best results, measure several times and average the results.

- 6) It may be necessary to modify your SPEED CAL number based on the amount of magnets you are using. The SCS 330 software assumes that 2 magnets are mounted on the wheel. If more than 2 magnets are used, the following calculation must be made.

**EXAMPLE:**

Assumed # of magnets = 2  
 Actual # of magnets = 6  
 Current SPEED CAL = 612 [155]

Corrected SPEED CAL =  $\frac{\text{Assumed \# of magnets} \times \text{current SPEED CAL}}{\text{Actual \# of magnets}}$

**ENGLISH UNITS:**  
 =  $\frac{2 \times 612}{6} = 204$

**METRIC UNITS:**  
 =  $\frac{2 \times [155]}{6} = [51.6]$

Corrected SPEED CAL is 204 [52]

## APPENDIX 2

# SPEEDOMETER DRIVE SPEED SENSOR INSTALLATION AND CALIBRATION PROCEDURE

### 1. MOUNTING THE SPEEDOMETER DRIVE SPEED SENSOR

- 1) Remove the existing speedometer cable from the back of the vehicle speedometer. Pull cable through fire wall into engine compartment.
- 2) Install adapter and key on speedometer cable and connect to Transducer Assembly. (Some units do not use adapter and key).
- 3) Connect Extension Cable to Transducer Assembly.

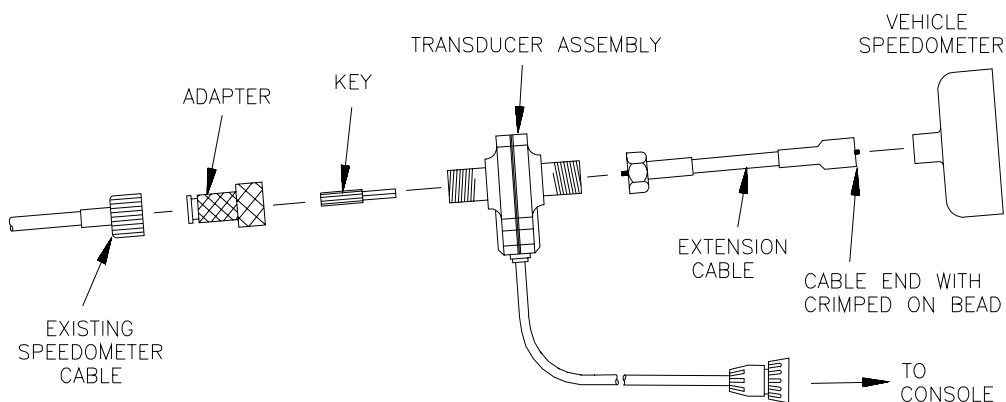

- 4) Push Extension Cable through fire wall and re-install on speedometer.
- 5) Connect the cable on the Transducer Assembly to the Console.
- 6) Secure all cables with plastic cable ties.

You are now ready to calibrate the Speedometer Drive Speed Sensor.

## 2. CALCULATING "SPEED CAL"

- 1) Complete "INITIAL CONSOLE PROGRAMMING" before doing this procedure.
- 2) Enter "0" in key labelled 

DISTANCE
7

 .
- 3) Enter a SPEED CAL of 306 [78] in key labelled 

SPEED CAL
4

 .
- 4) Drive 1 mile [1 km].

**CAUTION:** Do not use vehicle odometer to determine distance. Use section lines or Highway markers.

- 5) Read DISTANCE by depressing key labelled 

DISTANCE
7

 .
  - a) DISTANCE should read a value of approximately 5280 [1000]. If it reads between 5200-5350 [990-1010], the SPEED CAL for your vehicle is 306 [78].
  - b) If the DISTANCE display reads any other value, perform the following calculation:

Multiply the SPEED CAL by the target distance reading, then divide the sum by the actual value in DISTANCE display. This will give you the corrected value to enter for SPEED CAL. ***You must round off to the nearest 3 digit whole number.***

**EXAMPLE:**      SPEED CAL = 306 [78]  
                    Target distance reading = 5280 [1000]  
                    Assume the actual DISTANCE display reads 5000 [980]

<b>ENGLISH UNITS:</b>	<b>METRIC UNITS:</b>
$= \frac{306 \times 5280}{5000} = 323.1$	$= \frac{[78] \times [1000]}{[980]} = [79.6]$

- 6) The corrected number to enter for SPEED CAL is 323 [80].
- 7) Verify the corrected SPEED CAL number calculated above:
  - a) Zero out the DISTANCE display as in Step 2.
  - b) Enter the corrected SPEED CAL number as in Step 3.
  - c) Repeat Steps 4 and 5a. If DISTANCE value does not read correctly repeat Steps 5b, 6, and 7.

# APPENDIX 3

## ALTERNATE BY-PASS LINE PLUMBING SYSTEM

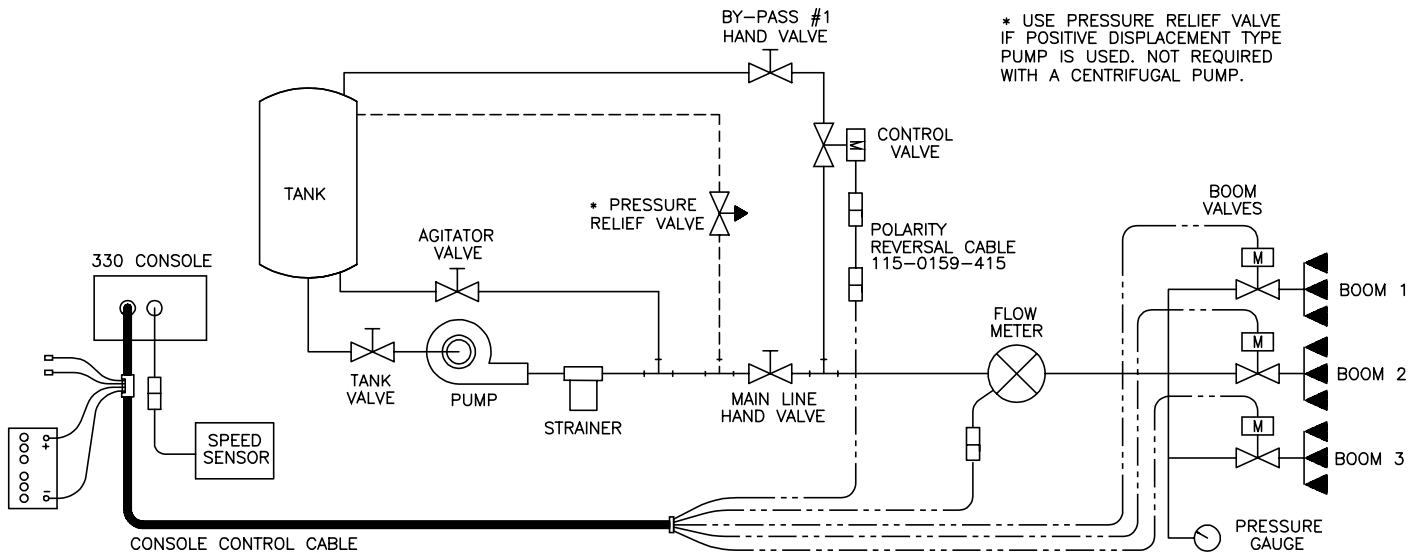

**FIGURE 11**

### INITIAL SYSTEM SET-UP

Plumb the system as shown in Figure 11.

Adjust as follows:

Install Polarity Reversal Jumper in motorized Control Valve Cable (P/N 115-0159-415).

- 1) Fill tank with water only.
- 2) Place MASTER ON/OFF switch to ON and BOOM ON/OFF switches to OFF.
- 3) Place AUTO/MAN/OFF switch to MAN.
- 4) Verify that Boom Widths, SPEED CAL, METER CAL, and RATE CALS have been entered correctly into the Console. In SELF TEST mode enter the normal sprayer operating speed.
- 5) With pump not running, fully open main line hand valve, fully open by-pass #1 hand valve, and completely close agitator line hand valve. If positive displacement pump is used, fully open the pressure relief valve (PRV).
- 6) Run pump at normal operating RPM.
- 7) If centrifugal pump is used, proceed with Step 8. If positive displacement pump is used, proceed as follows:
  - a) Place MASTER ON/OFF switch to OFF.
  - b) Close by-pass #1 hand valve.
  - c) Set PRV to 65 psi [450 kPa].
  - d) Open by-pass #1 hand valve.
  - e) Place MASTER ON/OFF switch to ON.

- 8) Verify that each boom valve operates and that no nozzles are plugged by operating the BOOM ON/OFF switches.
- 9) Place all BOOM ON/OFF switches to ON.
- 10) Hold the FLOW CONTROL switch to INC position for approximately 12 seconds. This assures motorized Control Valve is fully closed. (Pressure gauge is not supplied).

**NOTE:** A pressure gauge MUST be installed to properly adjust the system.

- 11) Adjust agitator line hand valve for desired agitation.
- 12) Close the main line hand valve, if necessary, to set the desired maximum operating pressure. Maximum pressure should be approximately 10 psi [70 kPa] above normal spraying pressure.  
**EXAMPLE:** If normal spraying pressure is 30 psi [210kPa], set maximum pressure at approximately 40 psi [280 kPa].
- 13) Hold the FLOW CONTROL switch to DEC position for approximately 12 seconds. This assures motorized Control Valve is fully open.
- 14) Close by-pass #1 hand valve to set the desired minimum operating pressure. Minimum pressure should be approximately one half the normal spraying pressure.  
**EXAMPLE:** If normal spraying pressure is 30 psi [210 kPa], set minimum pressure at approximately 15 psi [105 kPa].
- 15) Verify maximum and minimum pressures and RATE by repeating Steps 10 and 13.

## **INITIAL SYSTEM FIELD TEST**

- 1) Drive down field or road at target speed with sprayer booms OFF, to verify SPEED readout on Console.
- 2) Turn on sprayer and booms and place the OFF/MAN/AUTO switch to AUTO. Increase or decrease speed by one (1) MPH [2 km/h]. The system should automatically correct to the target application rate.
- 3) If for any reason, the system is unable to correct to the desired RATE, check for an empty tank, a plugged line, a malfunctioning pump, improper vehicle speed or a defect in the system.
- 4) If the system does not appear to be correcting properly, first review INITIAL SYSTEM SET-UP, then refer to TROUBLESHOOTING GUIDE.
- 5) At the end of each row, switch the MASTER ON/OFF switch to OFF to shut off flow. This also shuts off the area totalizer.
- 6) Verify area covered and volume used.

# APPENDIX 4

## PROCEDURE TO TEST SPEED SENSOR EXTENSION CABLES

Verify that the Console is in the SP1 Speed Sensor mode while testing the cable. Disconnect extension cable from Speed Sensor Assembly cable. Hold extension cable connector so that keyway is pointing in the 12 o'clock position.

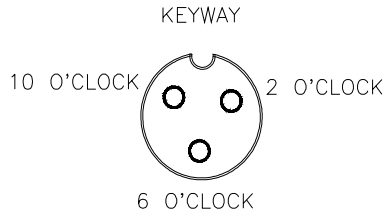

### PIN DESIGNATIONS



- 2 o'clock socket location is power.
- 10 o'clock socket location is ground.
- 6 o'clock socket location is signal.

### VOLTAGE READINGS

- 1) 10 o'clock socket to 6 o'clock socket = +5 VDC.
- 2) 10 o'clock socket to 2 o'clock socket = +5 VDC.

If a +5 VDC voltage reading is not present, disconnect the Flow Sensor cable. If the Speed reading is restored, Test the Flow Sensor cable per Appendix "PROCEDURE TO TEST FLOW METER CABLES".

### PROCEDURE TO CHECK CABLE:

- 1) Enter SPEED CAL number of 1000 in key labelled  .
- 2) Depress key labelled  .
- 3) With small jumper wire (or paper clip), short between the 10 o'clock and 6 o'clock sockets with a "short-no short" motion. Each time a contact is made, the DISTANCE total should increase by increments of 1 or more counts.
- 4) If DISTANCE does not increase, remove the section of cable and repeat test at connector next closest to Console. Replace defective cable as required.
- 5) Perform above voltage checks.
- 6) If all cables test good, replace Speed Sensor.

**NOTE:** After testing is complete, re-enter correct SPEED CAL number before application.

# APPENDIX 5

## PROCEDURE TO TEST FLOW METER CABLES

Disconnect cable from Flow Sensor. Hold Flow Sensor cable so that the keyway is pointing in the 12 o'clock position:

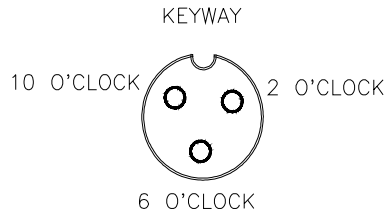

### **PIN DESIGNATIONS**



- 2 o'clock socket location is ground.
- 10 o'clock socket location is power.
- 6 o'clock socket location is signal.

### **VOLTAGE READINGS**

- 1) 2 o'clock socket to 6 o'clock socket = +5 VDC.
- 2) 2 o'clock socket to 10 o'clock socket = +5 VDC.

If a +5 VDC voltage reading is not present, disconnect the Speed Sensor cable. If the Flow reading is restored, Test the Speed Sensor cable per Appendix "PROCEDURE TO TEST SPEED SENSOR EXTENSION CABLES".

### **PROCEDURE TO CHECK CABLE:**

- 1) Enter a METER CAL number of one (1) in key labelled  .
- 2) Depress key labelled  .
- 3) Place BOOM switches to ON.
- 4) With small jumper wire (or paper clip), short between the 2 o'clock and 6 o'clock sockets with a "short-no short" motion. Each time a contact is made, the TOTAL VOLUME should increase by increments of 1 or more counts.
- 5) If TOTAL VOLUME does not increase, remove the section of cable and repeat test at connector next closest to Console. Replace defective cable as required.
- 6) Perform above voltage checks.
- 7) If all cables test good, replace Flow Sensor.

**NOTE:** After testing is complete, re-enter correct METER CAL numbers before application.



## APPENDIX 6

# FLOW METER MAINTENANCE AND ADJUSTMENT PROCEDURE

- 1) Remove Flow Meter from sprayer and flush with clean water to remove any chemicals.

**NH<sub>3</sub> WARNING:** Thoroughly bleed nurse tank hose and all other system lines prior to disassembling the Flow Meter, fittings, and hoses.

- 2) Remove flange bolts or clamp from the Flow Meter.
- 3) Remove the turbine hub and turbine from inside Flow Meter.
- 4) Clean turbine and turbine hub of metal filings or any other foreign material, such as wettable powders. Confirm that the turbine blades are not worn. Hold turbine and turbine hub in your hand and spin turbine. The turbine should spin freely with very little drag inside the turbine hub.
- 5) If transducer assembly is replaced or if turbine stud is adjusted or replaced, verify the turbine fit before reassembling. Hold turbine hub with turbine on transducer. Spin turbine by blowing on it. Tighten turbine stub until turbine stalls. Loosen turbine stud 1/3 turn. The turbine should spin freely.
- 6) Re-assemble Flow Meter.
- 7) Using a low pressure (5 psi) [34.5 kPa] jet of air, verify the turbine spins freely. If there is drag, loosen hex stud on the bottom of turbine hub 1/16 turn until the turbine spins freely.
- 8) If the turbine spins freely and cables have been checked per Appendix "PROCEDURE TO TEST FLOW CABLES", but Flow Meter still is not totalizing properly, replace Flow Meter transducer.

# APPENDIX 7

## PROCEDURE TO RE-CALIBRATE FLOW METER

- 1) Enter a METER CAL number of 10 [38] in the key labelled METER  
CAL  
5 .
- 2) Enter a TOTAL VOLUME of 0 in the key labelled TOTAL  
VOLUME  
9 .
- 3) Switch OFF all booms.
- 4) Remove a boom hose and place it into a calibrated 5 gallon [19 liter] container.
- 5) Switch ON appropriate boom switch (for the hose that was just placed into the 5 gallon container) and the MASTER switch. Pump exactly 10 gallons [38 liters].
- 6) Readout in TOTAL VOLUME is the new METER CAL number. This number should be within +/- 3% of the calibration number stamped on the tag of the Flow Meter.
- 7) Repeat this procedure several times to confirm accuracy. (Always "zero out" the TOTAL VOLUME display *before* retesting).

**NOTE:** For greatest precision, set METER CAL to 100 and pump 100 gallons (378 liters) of water.

- 8) To verify Flow Meter calibration, fill applicator tank with a predetermined amount of measured liquid (i.e. 250 gallons). **DO NOT RELY ON GRADUATION NUMBERS MOLDED INTO APPLICATOR TANK.** Empty the applicator tank under normal operating conditions. If the number displayed under TOTAL VOLUME is different from the predetermined amount of measured liquid by more than +/- 3%, complete the following calculation:

**EXAMPLE:**

METER CAL	=	720 [190]
TOTAL VOLUME	=	260 [984]
Predetermined amount of measured liquid	=	250 [946]

Corrected METER CAL =  $\frac{\text{METER CAL} \times \text{TOTAL VOLUME}}{\text{Predetermined amount of measured liquid}}$

**ENGLISH UNITS:**

$$= \frac{720 \times 260}{250} = 749$$

**METRIC UNITS:**

$$= \frac{[190] \times [984]}{[946]} = [198]$$

Corrected METER CAL = 749 [198]

- 9) Enter corrected METER CAL before resuming application.

# APPENDIX 8

## REMOTE SWITCH OPTION

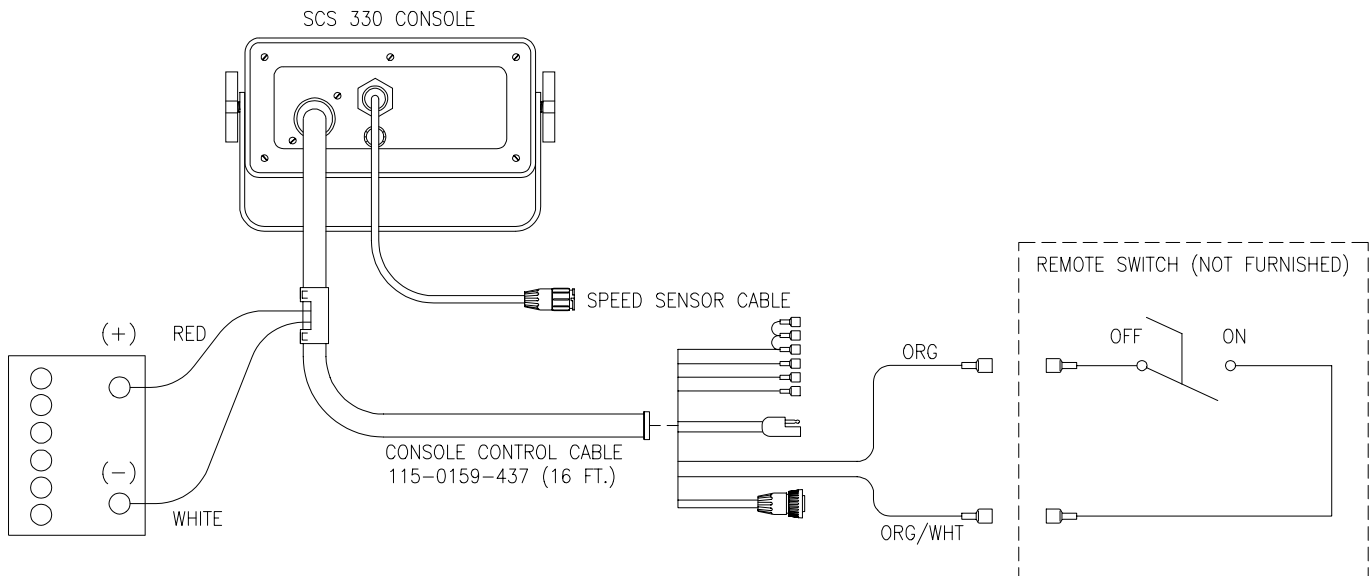

**FIGURE 12**

The REMOTE switch when installed is in parallel the Master switch; therefore switching on the REMOTE switch or the MASTER switch will energize the boom valves.

# APPENDIX 9 HIDDEN FEATURES

The SCS 330 Console is equipped with many hidden features. Several Console keys have multiple features located under them. The amount of time a key is held down determines the feature that will be displayed. The display will flash the coded name of the feature that is being programmed. These features and their display codes are outlined below:

## Console

Key	<u>Depress 5 seconds for:</u>	<u>Depress 7 seconds for:</u>	<u>Depress 9 seconds for:</u>
CE	Data Lock flashing "nEu.1" or "old"		
BOOM 1 CAL 1	Alarm Menu "A on" / "AoFF"	Display Smoothing "d on" / "doFF"	
BOOM 2 CAL 2	Program Rev. Number "-###"	Program Part Number "P #"	
BOOM 3 CAL 3	Off Target Alarm "or"		
SPEED CAL 4	Control Valve Delay "dLAY"		
METER CAL 5	Valve Cal "uCAL"		
FLOW RATE 6	Flow Rate "FLo"	Automatic Rate +/- "dELt"	Low Limit Alarm "LL"
DISTANCE 7			
SPEED 8	Self Test "tEst"		
TOTAL VOLUME 9			
TOTAL AREA 0	Display Units Alternates "US", "SI", or "tU" "SP1" or "SP2" "C-Sd" or "C-FC"		
ENTER			

# SCS 330 REPLACEMENT PARTS

ITEM	DESCRIPTION	RAVEN PART #
1	Master Switch	412-2011-037
2	Boom Switch	412-2011-038
3	Off/Man/Auto Switch	412-2011-052
4	Inc/Dec Switch	412-2011-053
5	Knob	309-1000-006
6	Mounting Bracket	107-0159-007
7	Console Control Cable (16 ft.)	115-0159-437
8	Kit, Cable Ass'y Terminals	117-0159-578
9	Screw, 6-32 UNC	321-0000-085
10	Connector Plate Assembly	063-0171-118
11	Screw, 6-32 UNC x 5/16"	311-0004-008
12	Internal Lockwasher	313-3000-007
13	Hex Nut	312-1001-014
14	Faceplate Assembly	063-0171-116
15	Display P.C. Assembly	064-0159-535
16	Spacer, Threaded	305-2540-625
17	Processor P.C. Assembly	064-0159-534
18	Enclosure, with Inserts	063-0171-135
19	SCS 330 Console	063-0171-115
20	10 ft. Console Control Cable (Optional)( Not Shown)	115-0159-418
21	12 ft. Flow Control Cable (Optional)( Not Shown)	115-0159-405
22	32 ft. Flow Control Cable (Optional) (Not Shown)	115-0159-706

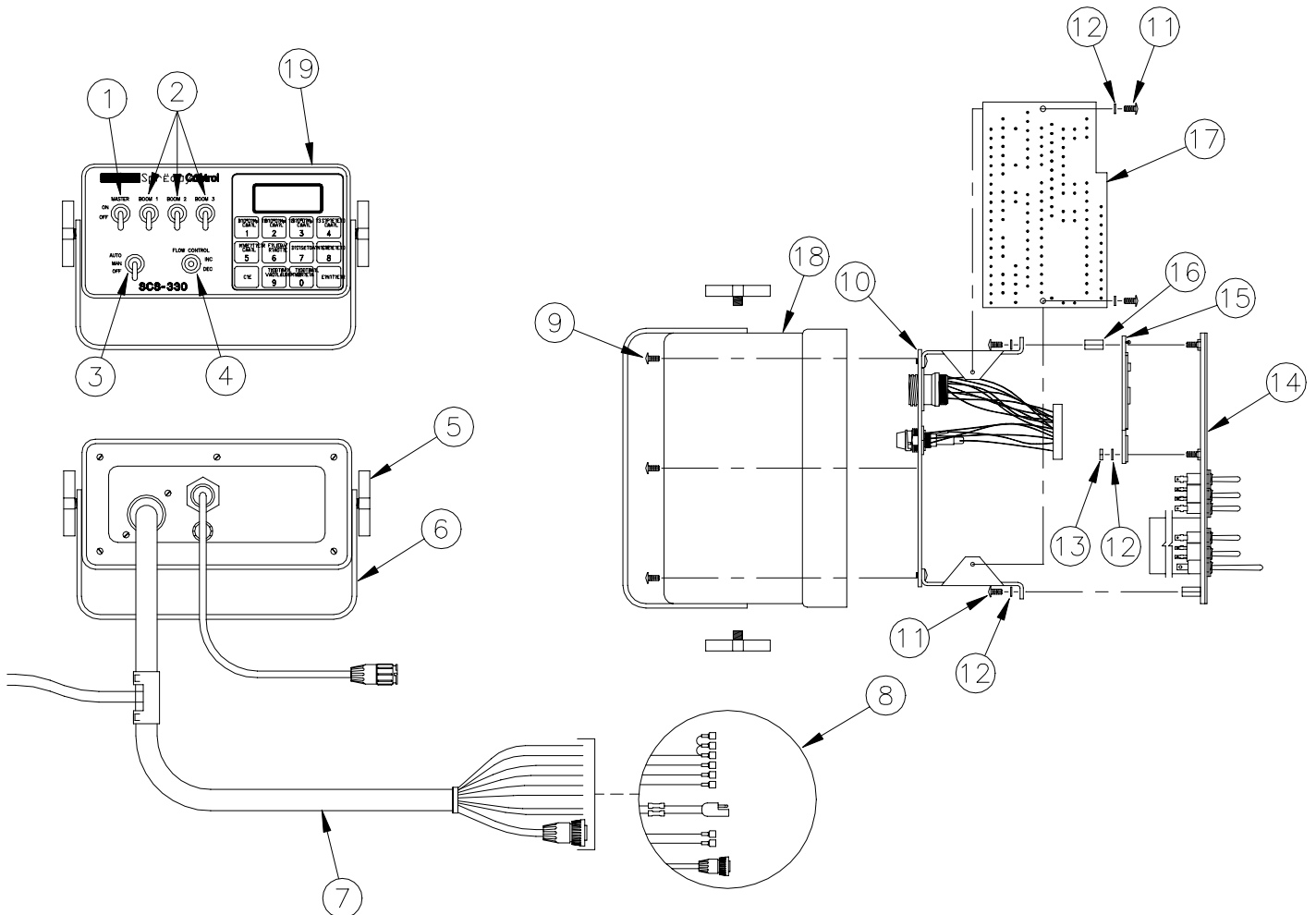



**RAVEN**

# **RAVEN INDUSTRIES**

## **Limited Warranty**

---

### ***What Does this Warranty Cover?***

This warranty covers all defects in workmanship or materials in your Raven Applied Technology Product under normal use, maintenance, and service.

### ***How Long is the Coverage Period?***

Raven Applied Technology Products are covered by this warranty for 12 months after the date of purchase. This warranty coverage applies only to the original owner and is nontransferable.

### ***How Can I Get Service?***

Bring the defective part and proof of purchase to your Raven Dealer. If your Dealer agrees with the warranty claim, the Dealer will send the part and proof of purchase to their distributor or to Raven Industries for final approval.

### ***What Will Raven Industries Do?***

Upon confirmation of the warranty claim, Raven Industries will, at our discretion, repair or replace the defective part and pay for return freight.

### ***What is not Covered by this Warranty?***

Raven Industries will not assume any expense or liability for repairs made outside our facilities without written consent. Raven Industries is not responsible for damage to any associated equipment or products and will not be liable for loss of profit or other special damages. The obligation of this warranty is in lieu of all other warranties, expressed or implied, and no person or organization is authorized to assume any liability for Raven Industries.

Damages caused by normal wear and tear, misuse, abuse, neglect, accident, or improper installation and maintenance are not covered by this warranty.

**R A V E N**

SCS 330  
Installation & Service Manual  
(P/N 016-0159-524 Rev E 2/09)

*Simply improving your position.<sup>SM</sup>*



Raven Industries  
Applied Technology Division  
P.O. Box 5107  
Sioux Falls, SD 57117-5107

Toll Free (U.S. and Canada): (800)-243-5435  
or Outside the U.S. :1 605-575-0722  
Fax: 605-331-0426  
[www.ravenprecision.com](http://www.ravenprecision.com)  
[atdinfo@ravenind.com](mailto:atdinfo@ravenind.com)

Notice: This document and the information provided are the property of Raven Industries, Inc. and may only be used as authorized by Raven Industries, Inc. All rights reserved under copyright laws.