

396-4412Y1



QuickDraw 3000 Operator's Manual



SCAN ME

QuickDraw 3000
Instructional Videos

*At the end of this manual is 396-4495Y1
Master Wiring Overview*



*It is the responsibility of the operator to read and understand
this manual for the safe operation of the QuickDraw.*

*The operator must follow all safety precautions from the
label of all products being used.*



Scan the Serial Number QR code from the right side wall inside the QD cabinet to register your QuickDraw.

Copy the information from the Serial Number label here:

Part Number: 605- _____

Serial Number : QD _____

Date: _____

Date Purchased; _____

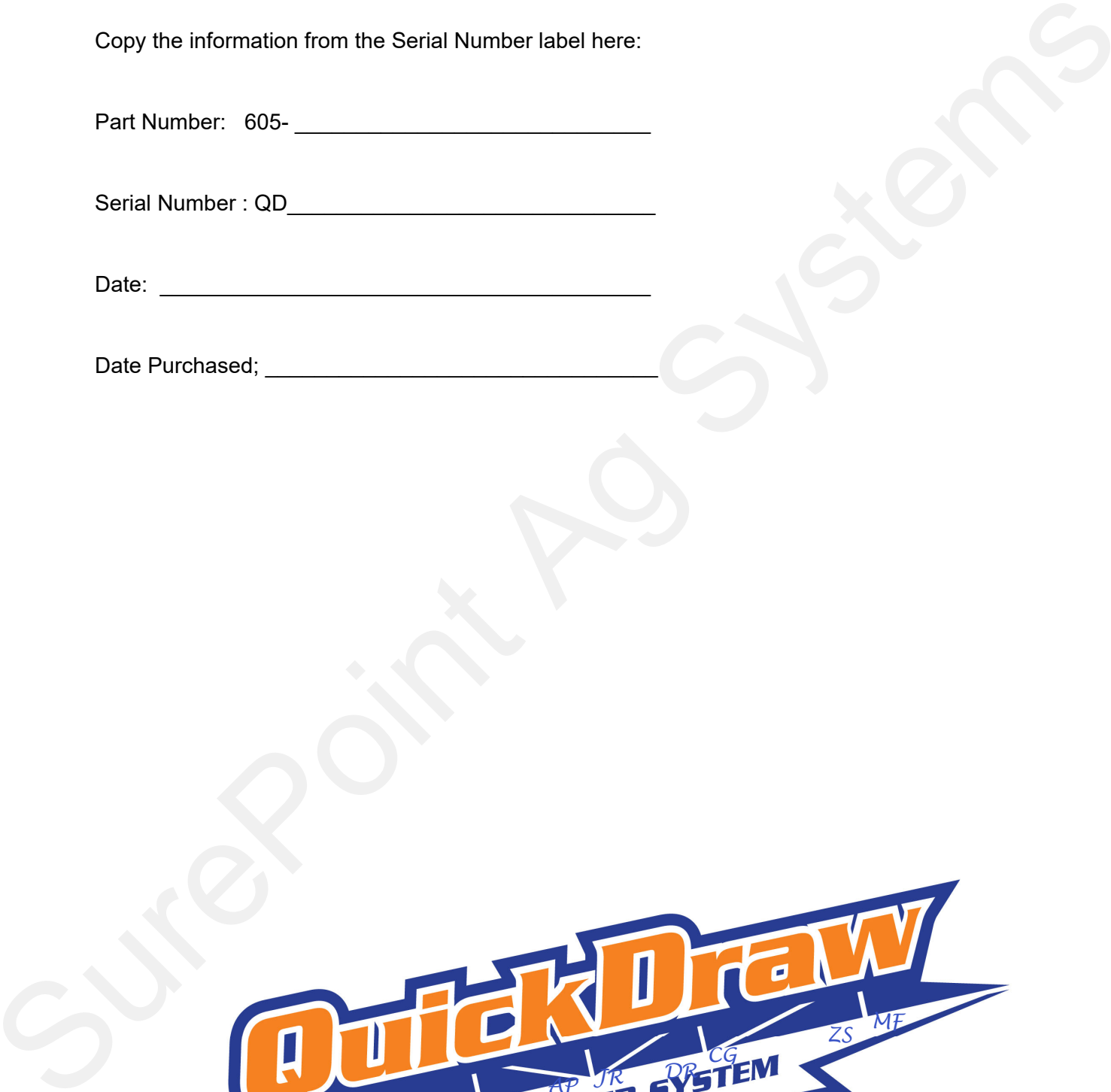

Table of Contents

Safety Information.....	3
QD3000 Instructional Videos	4-6
QuickStart Guide and Running a Batch	8-9
System Overview.....	10-11
QuickDraw Controller and iPad App Screens.....	12
Menu Screen	12-13
Run Screen.....	14-15
Job Screen	15-18
Product Hose Rinse Cycle.....	19-20
Alarms and Warnings	21-23
Manual Products.....	24
Pre-treating Carrier Water	25
Recipe Screens (Create and Edit).....	26-29
Tote (Product) Setup Screen	30
Carrier Setup Screen, Carrier Flowmeter Calibration	31-32
Advanced Settings Screen (including Multiple Carrier Setup), Diagnostics.....	33-34
IP Settings and Files.....	35
Carrier Blending (Multiple Carrier) Setup.....	36
Carrier (Select, Edit, Setup).....	37
System Settings.....	38-41
Remote Settings (including Wi-fi).....	42
Optional Remote Connectivity and Batch Complete Email	43
Field and Weather Settings	44
Maintenance Screen.....	45
History	47-51
Manual Operation	52
Mass Meter Data	53
Carrier Flowmeter.....	54
QuickDraw 3000 iPad App.....	56
iPad App Connection.....	56-59
iPad App Main Menu and Data Management Screen.....	60-61
iPad Settings Pages, Auto-Lock, and Maintenance.....	62
QuickDraw Plumbing	63
External Plumbing Fittings	63
Carrier/Product Plumbing and Flow.....	64
QuickDraw Main Plumbing Assembly and Carrier Flowmeter Inlet Assembly	66-67
QuickDraw Max Dimensioned Drawing	68-70
QuickDraw Connection Kits	71
Miscellaneous.....	72
Eductor Kits	72
Hose, Plumbing, and Valve Kits	73
Accessories & Replacement Parts.....	74-78
Common Troubleshooting Issues	79-80
Winterization.	81-82
Software Updates	83-85
Glossary of Terms	86-87

©2020-2022 SurePoint Ag Systems, All Rights Reserved



Software Update



Before you begin using your new QuickDraw 3000, check to see that it has the latest software.

On the QD Controller > MENU > MAINTENANCE > Look at Software Rev and Display Rev.



MAINTENANCE

Model Code:

100-1.17-6-137

Software Rev: 2.3.7

Display Rev: 1.17

Note: Pressing the RESET buttons will erase the current valve address.

Go to the SurePoint Support website (support.SurePointag.com/products/218)

Go to Home > Categories > Spray Tender Products > QuickDraw 3000 Max > QuickDraw 3000 Max (10/2019-Present)

On the right-hand side of the screen there are links to download different documents. Scroll down to “Software Update”, under which will be “QuickDraw 3000 Display Controller Firmware V.....” and “QuickDraw 3000 Display Software Update V”.

If your Software and/or Display Rev are not the latest > Click on both links to download the software to your computer.

Follow the rest of the Software Update instructions found on pages 79-81 of the QD 3000 manual.

Register your QuickDraw by scanning the QR code on the Serial Number label on the right inside wall of the QuickDraw cabinet. Complete the registration information on the website where the QR code takes you.

Thank you for purchasing a QuickDraw 3000 from SurePoint Ag Systems.



Safety

TAKE NOTE! THIS SAFETY ALERT SYMBOL FOUND THROUGHOUT THIS MANUAL IS USED TO CALL YOUR ATTENTION TO INSTRUCTIONS INVOLVING YOUR PERSONAL SAFETY AND THE SAFETY OF OTHERS. FAILURE TO FOLLOW THESE INSTRUCTIONS CAN RESULT IN INJURY OR DEATH.



Note the use of the signal words DANGER, WARNING and CAUTION with the safety messages. The appropriate signal word for each has been selected using the following guidelines:



DANGER: Indicates an imminently hazardous situation that, if not avoided, will result in death or serious injury. This signal word is to be limited to the most extreme situations typically for machine components which, for functional purposes, cannot be guarded.



WARNING: Indicates a potentially hazardous situation that, if not avoided, could result in death or serious injury, and includes hazards that are exposed when guards are removed. It may also be used to alert against unsafe practices.



CAUTION: Indicates a potentially hazardous situation that, if not avoided, may result in minor or moderate injury. It may also be used to alert against unsafe practices.

NOTICE is used to address safety practices not related to personal safety.



The QuickDraw is designed to batch and mix agricultural chemicals.

It is the responsibility of the user to store, handle, and mix these chemicals safely.

The operator should refer to the chemical label and MSDS for complete instructions on handling and mixing of the products being used.

All operators should be trained in the safe handling of chemicals, personal protective equipment needed, and what to do in the case of a chemical spill.

Learn via Video

QuickDraw 3000 Instructional Videos

Scan the QR Code at the right with your phone camera or click on the QR Code to go to the SurePoint Ag YouTube Channel to see this entire group of videos on the operation of the QuickDraw 3000, or scan on the list for a single video.



Click on any QR Code or scan with camera to see video.



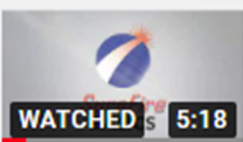

1  **QD3000 - Operation and Navigation**
SureFire Ag Systems
WATCHED 3:24

2  **QD3000 - Creating a New Recipe**
SureFire Ag Systems
7:34

3  **QD3000 - Setting Up Job Preparing to Load a Batch**
SureFire Ag Systems
WATCHED 5:18



4  **QD3000 - Product Hose Rinse Cycle**
SureFire Ag Systems
2:46

5  **QD3000 - Update Software**
SureFire Ag Systems
WATCHED 3:11















6  **QD3000 Run Screen and Batch Operation**
SureFire Ag Systems
4:48

7  **QD3000 Connecting to iPad App**
SureFire Ag Systems
WATCHED 3:48









8  **QD3000 Creating Recipe on iPad App
and Transferring to QD Controller**
SureFire Ag Systems
5:00

- 9  **QD3000 Editing an Existing Recipe**
SureFire Ag Systems
WATCHED 2:11 
- 10  **QD3000 Carrier Fill to Trailer and Treating with Water Conditioner**
SureFire Ag Systems
3:33
- 11  **QD3000 Inventory Mgmt Features**
SureFire Ag Systems
WATCHED 3:19 
- 12  **QD3000 Operating System with Manual Controls**
SureFire Ag Systems
4:12
- 13  **QD3000 Pump Suction Configuration Settings and Features**
SureFire Ag Systems
WATCHED 2:38 
- 14  **QD3000 Settings Page Overview**
SureFire Ag Systems
8:18
- 15  **QD3000 Carrier Blending**
SureFire Ag Systems
WATCHED 5:05 
- 16  **QD3000 Carrier Flow Meter Automated Calibration Process**
SureFire Ag Systems
1:27

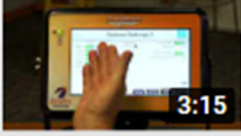
Scan the QR Code at the right with your phone camera or click on the QR Code to go to the SurePoint Ag YouTube Channel to see this entire group of videos on the operation of the QuickDraw 3000, or scan on the list for a single video.



- 17  **QD3000 Emailing History from iPad App**
SureFire Ag Systems
3:18
- 18  **QD3000 Individual Volumes Calculation Mode**
SureFire Ag Systems
4:37
- 19  **QD3000 Automatic vs. Manual Control of Carrier Blending Valves**
SureFire Ag Systems
3:26
- 20  **QD3000 Adjusting Tuning for Greater Accuracy**
SureFire Ag Systems
3:15
- 21  **QD3000 Product Hose Rinse**
SureFire Ag Systems
4:10
- 22  **QD3000 Automated Load Hose Purge**
SureFire Ag Systems
1:53
- 23  **QD3000 Carrier Refill Feature**
SureFire Ag Systems
2:31

SurePoint Ag Systems



QuickStart Guide (see the manual for full details)

QuickDraw 3000 iPad App

See page 56 of the QD 3000 manual for more instructions on the iPad app. The QD3000 iPad app is not the same as the original QuickDraw iPad app. User must download the QD3000 app.

(If using one iPad for more than one QuickDraw, the DATA transfer may be done differently.)

On the iPad app (OFFLINE - indicated by Red X at the top of the screen)

MENU > DATA MANAGEMENT > Add Grower/Farm/Field (optional)

DATA MANAGEMENT > Add Carrier and Product(s)

DATA MANAGEMENT > Add Recipe(s). SAVE when recipe is complete.

Repeat for additional Grower/Farm/Field information, additional Products, and additional Recipes.

Connect iPad to QuickDraw:

1. Turn on the QuickDraw controller and open the QuickDraw 3000 App on the iPad.
2. On each device go to **SETTINGS > REMOTE SETTINGS**.
3. On each device enter **USER NAME**, **Remote PASSWORD**, and **QuickDraw ID**. At least one of these must be changed from the default settings (typically will change the QuickDraw ID).
4. On the controller, press **WI-FI SETTINGS** or **WI-FI**. Note or set up **SSID (QuickDraw)** and **Password (SurePoint)**.
5. Note the **IP Address** on the Controller **WI-FI** page. **WI-FI IP** on iPad must match this.
6. Save the **WI-FI Settings** and reboot the controller.
7. After rebooting, connect the iPad to the **WI-FI network** you just set up on the controller: (iPad > Settings > WI-FI > QuickDraw > SurePoint (password)).
8. Go to the QuickDraw app. There should be green bars at the top of the iPad App screen, indicating that the iPad and controller are connected. (If not connected, press the red X.)

On the iPad app: **MENU > DATA MANAGEMENT > SEND & DELETE**.

The information and recipes you entered on the iPad are now on the QuickDraw controller.

With the iPad connected, the rest of this may be done from the iPad or from the QuickDraw.

JOB SCREEN

Name	Rate	Order	Prod Volume	Total	Inv.	Prod Rinse
Carrier: Water	13.9 GPA			1114.6 GAL		3 Sec
Tote 1: Arrow	2.00 Pt/Ac	5	20.0 GAL	20.0 GAL		Final Rinse
Tote 2: Bravo	32.00 fl. Oz/Ac	3	20.0 GAL	20.0 GAL		10 Sec
Tote 3: Champion	24.00 fl. Oz/Ac	2	15.0 GAL	15.0 GAL		
Tote 4: Durango	16.00 fl. Oz/Ac	4	10.0 GAL	10.0 GAL		
Tote 5: NO PRODUCT	.00 GAL/Ac	0	.0 GAL	.0 GAL		
Tote 6: NO PRODUCT	.00 GAL/Ac	0	.0 GAL	.0 GAL		
Man. Prod 1: AMS	17.00 lbs/100	1	204.0 lbs	20.4 GAL		
Man. Prod 2: NO PRODUCT	.00 GAL/Ac	0	.0 GAL	.0 GAL		
Man. Prod 3: NO PRODUCT	.00 GAL/Ac	0	.0 GAL	.0 GAL		
Man. Prod 4: NO PRODUCT	.00 GAL/Ac	0	.0 GAL	.0 GAL		
Man. Prod 5: NO PRODUCT	.00 GAL/Ac	0	.0 GAL	.0 GAL		

Recipe: Example Recipe Total Acres: 80.0 App Rate: 15.0 GPA
Calculation Mode: Volume & App Rate Total Volume: 1,200.0 GAL PreLoad Vol: 250.0 GAL

Field/Weather EDIT RUN MENU

FIELD AND WEATHER SETTINGS

FIELD AND WEATHER SETTINGS

Grower: MAW Field: W80
Farm: Rawlins Recipe: Example Recipe
Operator: Machine:
Crop: Pest:

Temperature: 66.0 °F Wind Dir/Speed: SW 4.0 MPH Boom Height: 0.0 Inches

JOB RUN MENU



Running a Batch on the QuickDraw 3000

1. Turn on the QuickDraw controller. The following steps can be done from the QD screen or from the iPad App if it is connected to the QuickDraw.
2. Open the **Job Screen**. (MENU > JOB)
3. Press on the box beside **Recipe**. Select a **Recipe** or create a new recipe.
4. On the Job Screen, select or verify the **Calculation Mode** (Volume & App Rate, Area & App Rate, Individual Volume, or Area and Carrier Rate).
5. Depending on Calculation Mode, enter the **Total Acres**, **App Rate**, and/or **Total Volume** for the batch.
6. Enter the **Preload Vol(ume)** (this is how much carrier (water) will be added at the start of the batch before any other products are added).
7. Verify that the totes/chemicals shown are correct and connected to the valve shown.
8. Verify/change the **Rate** for each product. Rates can be changed on this screen to be effective for this batch. To only change the rate for this batch, do NOT press SAVE. To change a rate for this batch and for all future batches with this recipe, make the change and then press SAVE. The recipe will be saved with the new rate.
9. Verify the **Order** that products will be added. If **Order** needs to be changed, press **EDIT** at the bottom of the screen and make the desired changes.
10. Press on **Field/Weather** to enter **Grower**, **Farm**, **Field**, **Operator**, **Crop**, **Machine**, **Pest**, **Temp**, **Wind Speed / Direction** and **Boom Height**. These are optional entries, but will add information to the historical record for each batch. Return to Job Screen.
11. Pressing on **EDIT** will show the Totes with Rates and Load Order. Pressing on any blue box will do the same thing.
12. Press on the arrow under **Inv(entory)** to verify/update the amount of chemical in the Tote.
13. **Prod Rinse**: Default and minimum time is 3 seconds; it can be set for more. The product valve manifold will rinse for this time between every chemical that is loaded.
14. **Final Rinse**: Default and minimum time is 10 seconds. Longer times may be used. After all products/chemicals are loaded the product valve manifold will rinse for this amount of time.
15. Verify that **Prod Volume** and **Total Gallons** for each product appear reasonable for this batch and that there is enough product in each tote to complete the batch. See **Inv(entory)** above.
16. Verify that all tote valves are in correct position and that all hoses are connected properly.
17. When all is ready on the **Job Screen**, press **RUN** to go to the **RUN SCREEN** (this does NOT start the batch).
18. Start the pump when ready to run the batch, and then, on the **RUN SCREEN**, press **START**.

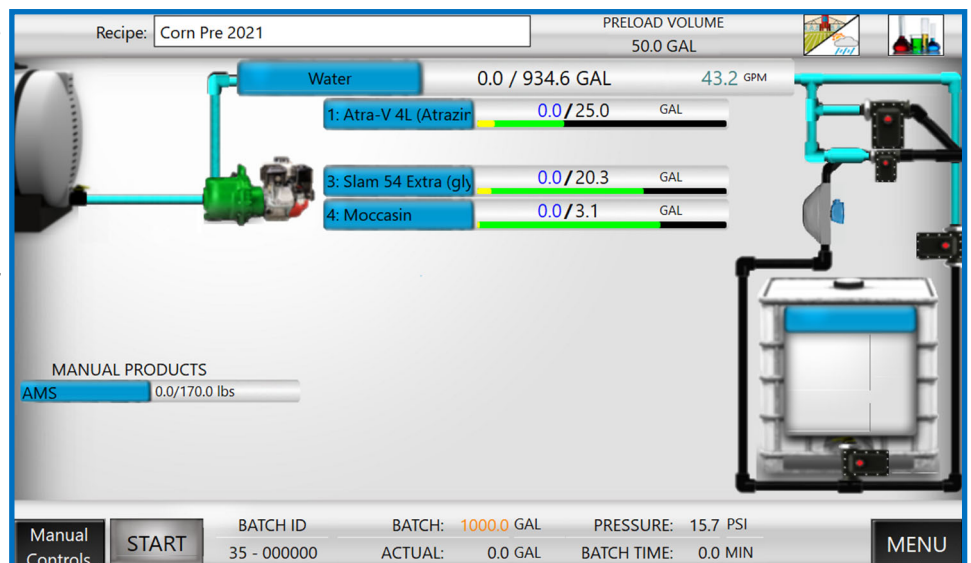

System Overview

The QuickDraw spray tender system makes the process of tendering your sprayer more efficient and more accurate, with greater safety. The system provides a historical record of each batch. The system allows the batching of either 4, 6, or 9 bulk products, depending on which model was purchased, plus 5 manual products. The QuickDraw controller works together with the iPad app to simplify the management of your sprayer batches. Configuration of recipes can be handled in either the QuickDraw controller or on the iPad QuickDraw app. The iPad QuickDraw app is the preferred method for recipe configuration due to its portable nature and ease of use. The QuickDraw app communicates with the QuickDraw controller via WI-FI. The QuickDraw controller takes these recipes and automatically handles the calculations and measurements necessary to complete a batch that ends up in the sprayer. The iPad can be used to start a batch and to monitor/control the mixing operation. Once a batch is completed, the information for that batch is logged in the controller. The QuickDraw app can then be used to send the historical information out of the controller to the iPad.

The QuickDraw manages bulk liquid products automatically. These are products typically stored in bulk totes or shuttles. The QuickDraw also calculates the correct amount of manual measured products in a batch. Manual measured products include small-package liquids, dry flowables, and powders. Each recipe can include up to 5 manual products.

Mass Meter Description

The QuickDraw takes advantage of mass meter technology to provide accuracy to the spray tendering system. The mass meter in the QuickDraw uses the Coriolis Effect to determine the mass and density of the product running through it. This can then be converted to volume and used for batching a specific volume amount. Other flowmeter technologies have the disadvantage of being affected by density and/or temperature changes whereas the mass meter accuracy and repeatability is not affected by changes in viscosity due to temperature and changes in density due to product differences. In a batching system like the QuickDraw where product is diluted immediately by loading directly into a carrier stream, calibration is not feasible. The mass meter allows the QuickDraw to be accurate from product to product and from batch to batch and from morning to afternoon without recalibration.

QuickDraw and iPad

The QuickDraw is designed to be used with an iPad. Creating and editing recipes, managing farms, fields, and products, configuring totes, and setting up batches can all be done on the QuickDraw controller or the QuickDraw iPad App. The iPad App can be used to start a batch and to monitor the batch while it is running. Batch history is downloaded to the iPad to be accessible outside the controller. If an iPad is temporarily unavailable, the QuickDraw controller is fully functional without the iPad.

Venturi and Pump Suction Configuration

The QuickDraw is available in two configurations, Venturi Suction and Pump Suction. Venturi Suction is the most common. In **Venturi Suction** the transfer pump is located on the QuickDraw inlet. It pushes water across a venturi to create suction which draws chemical products through the mass meter and into the batch. In a **Pump Suction** setup, the transfer pump is located on the Quick Draw outlet. Suction from the pump is utilized to draw chemical products through the mass meter and into the batch. The Pump Suction setup allows the unit to make smaller batches or batches with a higher concentration of chemical.

The QuickDraw should only be used with a wet-seal pump.

The standard product valve is a 1" Port Valve. Each QuickDraw will have at least one 1 1/2" valve to speed up the transfer of high volume and/or heavier products. The 4-product QuickDraw comes with one of these 1 1/2" valves. The 6-product can be set up with either one or three 1 1/2" valves. The 9-product comes with three 1 1/2" valves.

It is essential before each batch is run to verify that the recipe being used has the chemicals matched correctly with the valves they are connected to, as shown on the QuickDraw Run Screen.

Batches less than 100 gallons may not have time to dispense all the chemicals desired before the Total Carrier amount has been pumped. The carrier is pumped at approximately 50 gallons per minute while the products are being dispensed through the Venturi system. Also, batches that have 35% or more of the batch volume from the chemical products may not complete. The message *Batch Unlikely to Complete, >65% of the Total Batch needs to be carrier in order to guarantee batch success* will display if such a batch is set up. The Pump Suction setup may sometimes be a better option if small batches or batches with a high concentration of chemical are needed.

Air Leaks The QuickDraw will not work properly if there are any air leaks in the plumbing on the suction side of the venturi. Air leaks will create pump priming problems and will cause the flow-meters to behave erratically. Air leaks can result in inaccurate chemical measurement. It is essential that all hoses and connections be airtight.

Automated Air Purge Cycle: An optional accessory that will use compressed air to automatically purge the hose from the QuickDraw to the sprayer after each batch is run.



Before operating the QuickDraw, the user must be familiar with the chemical products to be used. Read the label for each product, understand and follow all precautions for safe handling, mixing, and application of the products being used. Wear any required PPE and be prepared to act in the event of an unintended release of any product.

QuickDraw Controller (and also on the iPad App) Menu Screen

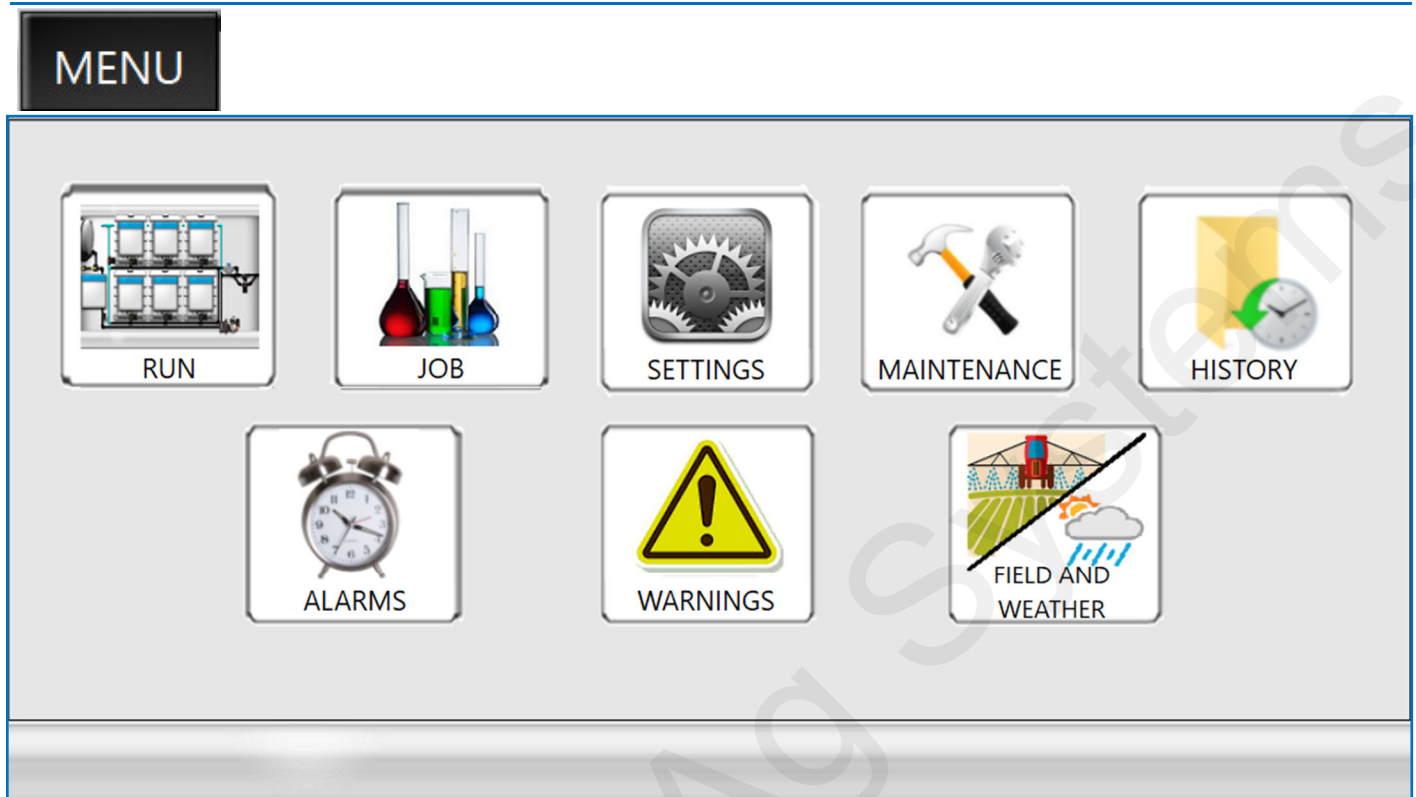

When the Power is turned on, QuickDraw defaults to the RUN SCREEN. Navigate to the MENU SCREEN by pressing “MENU” in the bottom right corner.

Menu Screen:

This screen allows access to the different sections of the controller.

RUN: Gives access to the main operational screen that shows live data during batch operation. All the operational and data management screens are available from here.

JOB SCREEN: Shows the job screen that is used to set up the current job that will be batched out. From here a new recipe can be created or an existing recipe can be loaded and edited.

SETTINGS: Global settings to the controller are changed here. There are 2 System Settings screens.

MAINTENANCE: This screen allows access to maintenance items that rarely need accessed.

HISTORY: Allows access to the historical log stored in the controller.

ALARMS: Alarms will prevent a batch from running. Press the **ALARMS** button to go the **ACTIVE ALARMS** screen to resolve the issue to continue running a batch.

WARNINGS: A batch will continue running with Warnings, but there may be a problem with completing the batch as desired. Press **WARNINGS** to see **ACTIVE WARNINGS** to resolve any issues.

FIELD AND WEATHER: This brings up a screen to enter the Grower, Farm, Field, Recipe, Temperature, Wind Speed/Direction and other information for the current batch record.

The iPad Menu screen will have one additional button: **DATA MANAGEMENT**

Press **DATA MANAGEMENT** while working OFFLINE with the iPad to access screens to add Grower, Farm, Field, and Product information, and to create Recipes. Go to this screen to begin transferring that data to the QuickDraw controller when the iPad is connected to the QuickDraw.



SurePoint Ag Systems

Run Screen

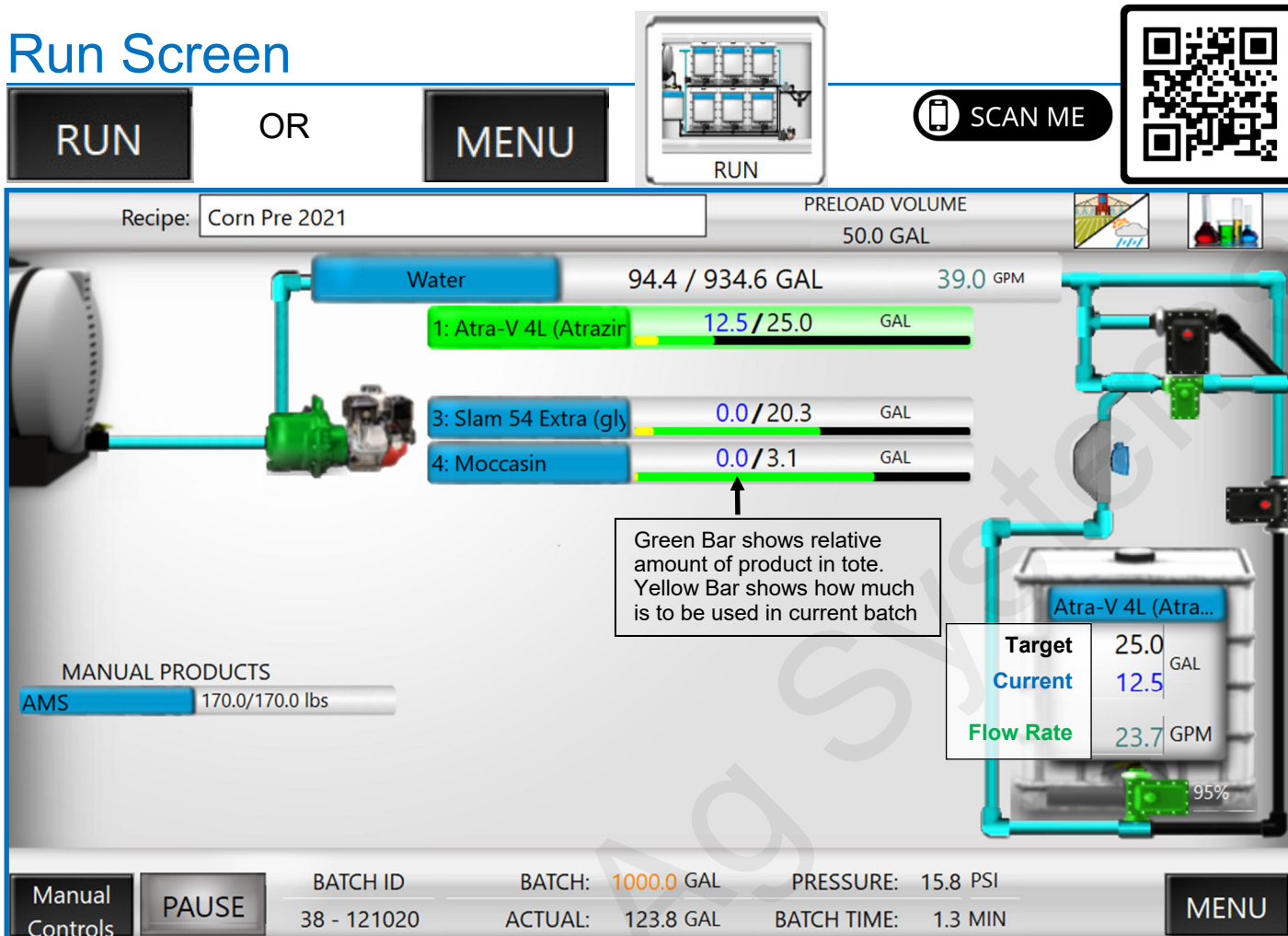

RUN SCREEN:

This screen contains all the real-time data that occurs during operation. Each box on the screen represents one of the shuttles or totes connected to the system. Each shuttle also corresponds with a specific product valve on the QuickDraw. The numbering of the totes starts at the top and proceeds down in numerical order. Totes that do not have a product in the current batch will not be shown. The corresponding valves on the side of the QuickDraw are valves 1 to 4 (or 6 or 9), starting from the large valve at the bottom and counting up from there. The tote will be green when it is dispensing. The first number shows the amount that has been dispensed; the second number is the target amount. The tote at the top of this screen shows the carrier flow information. **Press on a tote** to bring up the *TOTE SETUP SCREEN*.

The tote in the bottom right corner is the tote that is currently dispensing product. The **black number** in that tote contains the **target value** for this batch and is the result of the calculations on the Job Screen. The **blue number** in each tote contains the **current total value** (running total) that has been dispensed for this batch from that tote. This number will increase as the product in that tote is being dispensed. The system will switch to the next product in the sequence once the blue number equals the black number. The **green number** shows the **flow rate** of the product into the batch, so it will show how fast the product is added into the batch. *The units displayed for these three numbers are determined by the "Volume Units" selected for that product on the Recipe screens. So, your prescription or rate/acre could be in oz, but if gallons is selected for volume units, it will display in gallons here.*

Any manual products in the batch will be shown on the left side.

At the top of the screen, press the **RECIPE** box to select a recipe or to create a new recipe.

The left icon on the top row is the **FIELD AND WEATHER** button. Press this to enter **Grower, Farm, Field, Operator, Crop, Machine, Pest, Temp, Wind Speed / Direction and Boom Height**. These are optional entries, but will add information to the historical record for each batch.

The final icon on the top row is for the **JOB SCREEN**. Press this to return to the Job Screen to make changes for the current batch.

The bottom of the Run Screen contains the information about the entire batch. The **batch id** is a **unique number created for every batch** that can be used to tie this batch with other data that is being used elsewhere. Both sets of data can be correlated by using the batch id.

The **orange number** is the **calculated target total batch size** for this batch. This will be the **final batch size** that is loaded. The **black number in the bottom** that has the label **ACTUAL**: will count up as the batch is running and **the batch will complete when it reaches the target**.

The pump pressure is shown under **PRESSURE** and is a **monitor-only value** for troubleshooting but does not have any control of the process. The **BATCH TIME** displays how long the batch took to complete.

The **START** button is used to initiate a batch. Once initiated, this button changes from START to **PAUSE**. Once the batch is active, pushing the PAUSE will put the process into a paused state. By default, the pump will continue to run but the valves will be closed. On the Settings page, this can be changed to kill the pump when paused. Pushing the PAUSE also causes another window to pop up that gives you the choice to **RESUME**, **SKIP PRODUCT**, or **TERMINATE BATCH**. If the batch needs to be terminated, push the TERMINATE button. If the batch is ready to continue, then push the RESUME button.

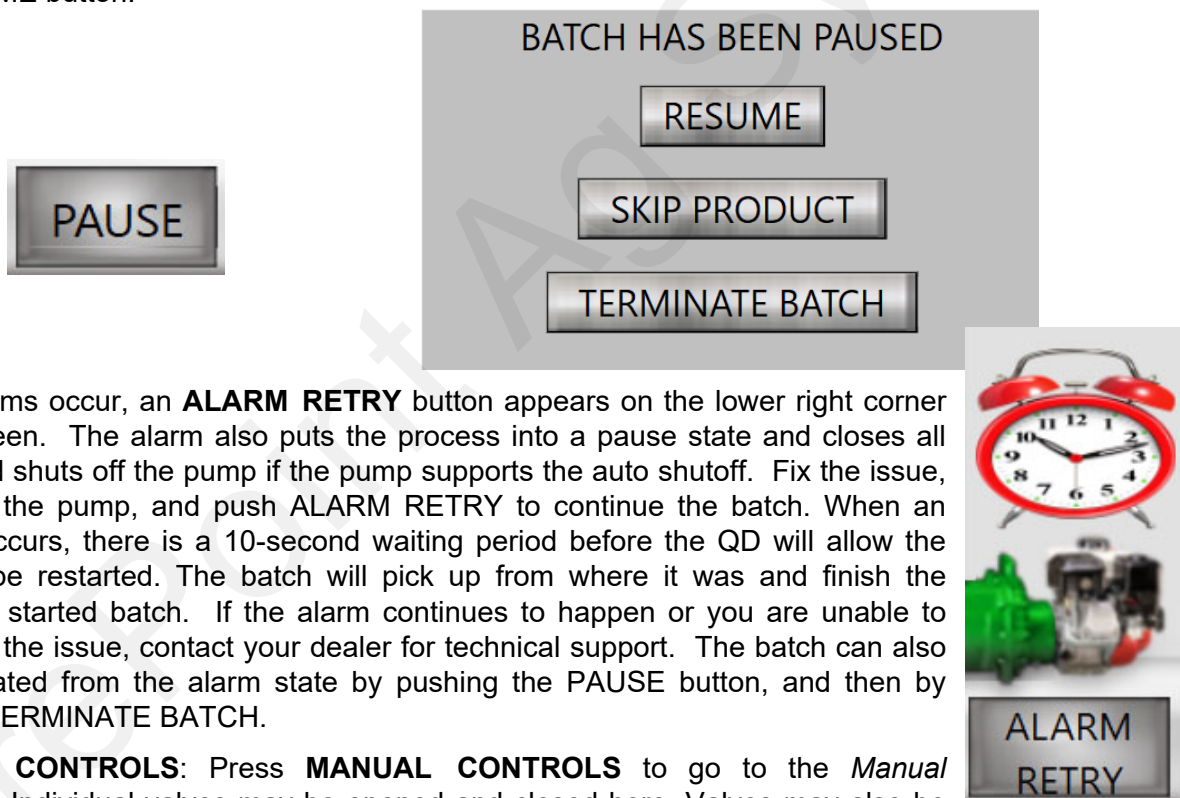

When alarms occur, an **ALARM RETRY** button appears on the lower right corner of the screen. The alarm also puts the process into a pause state and closes all valves and shuts off the pump if the pump supports the auto shutoff. Fix the issue, then start the pump, and push ALARM RETRY to continue the batch. When an ALARM occurs, there is a 10-second waiting period before the QD will allow the pump to be restarted. The batch will pick up from where it was and finish the previously started batch. If the alarm continues to happen or you are unable to determine the issue, contact your dealer for technical support. The batch can also be terminated from the alarm state by pushing the PAUSE button, and then by pressing TERMINATE BATCH.

MANUAL CONTROLS: Press **MANUAL CONTROLS** to go to the *Manual Operation*. Individual valves may be opened and closed here. Valves may also be controlled by pressing the valve icon on the Run screen. This is not necessary for normal operation but may be useful for troubleshooting or some other uses.

MENU: Press **MENU** to return to the main menu screen.



Running a batch will dispense chemical products. Be sure that the totes are identified correctly in the QuickDraw and that all hoses are connected securely and all manual valves are in the correct position. Know how to operate the E-stop.

Job Screen



JOB
OR
MENU

Recipe:

Total Acres

App Rate GPA

Calculation Mode

Volume GAL

PreLoad Vol GAL

Name	Rate	Order	Prod Volume	Total	Inv.	Prod Rinse
Carrier: Water	9.3 GPA			934.6 GAL	→	<input type="text" value="3"/> Sec
Tote1: Atra-V 4L (Atrazine)	<input type="text" value="1.00"/> Qt/Ac	2	25.0 GAL	25.0 GAL	→	Final Rinse <input type="text" value="10"/> Sec
Tote2: NO PRODUCT	<input type="text" value="0.00"/> GAL/Ac	0	0.0 GAL	0.0 GAL	→	
Tote3: Slam 54 Extra (glyph)	<input type="text" value="26.00"/> fl. Oz/Ac	3	20.3 GAL	20.3 GAL	→	
Tote4: Moccasin	<input type="text" value="4.00"/> fl. Oz/Ac	4	3.1 GAL	3.1 GAL	→	
Tote5: NO PRODUCT	<input type="text" value="0.00"/> GAL/Ac	0	0.0 GAL	0.0 GAL	→	
Tote6: NO PRODUCT	<input type="text" value="0.00"/> GAL/Ac	0	0.0 GAL	0.0 GAL	→	
Man. Prod1: AMS	<input type="text" value="17.00"/> lbs/100	1	170.0 lbs	17.0 GAL		
Man. Prod2: NO PRODUCT	<input type="text" value="0.00"/> GAL/Ac	5	0.0 GAL	0.0 GAL		
Man. Prod3: NO PRODUCT	<input type="text" value="0.00"/> GAL/Ac	0	0.0 GAL	0.0 GAL		
Man. Prod4: NO PRODUCT	<input type="text" value="0.00"/> GAL/Ac	0	0.0 GAL	0.0 GAL		
Man. Prod5: NO PRODUCT	<input type="text" value="0.00"/> GAL/Ac	0	0.0 GAL	0.0 GAL		

PRODUCT HOSE
RINSE DISABLED

Field/
Weather

EDIT

RUN

MENU

JOB SCREEN:

The **Job Screen** is used for setting up and verifying the batch to be run. Changes can be made here to the basic Recipe that will apply only to the batch about to be mixed.

1. Verify the **Recipe** at the top left or press on the box to select or create a different recipe.
2. Select or verify the **Calculation Mode** (Volume & App Rate, Area & App Rate, Individual Volume, or Area and Carrier Rate).
3. Depending on Calculation Mode, enter the **Total Acres**, **App Rate**, and/or **Total Volume** for the batch.
4. Enter the **Preload Vol(ume)**.
5. Verify that the totes/chemicals shown are correct and connected to the valve shown.
6. Verify/change the **Rate** for each product. Rates can be changed on this screen to be effective for this batch. To only change the rate for this batch, do NOT press SAVE. To change a rate for this batch and for all future batches with this recipe, make the change and then press SAVE. The recipe will be saved with the new rate.
7. Press on **Field/Weather** to enter **Grower, Farm, Field, Operator, Crop, Machine, Pest, Temp, Wind Speed / Direction and Boom Height**. These are optional entries, but will add information to the historical record for each batch.
8. Press on **EDIT** to see/change the Totes with Rates and Load Order. Pressing on any blue box will do the same thing.
9. Press on the arrow under **Inv(entory)** to verify/update the amount of chemical in the Tote.
10. Press **RUN** to go to the RUN SCREEN (this does NOT start the batch).

Recipes consist of automated bulk products and manually added products. The automated bulk products are the products that are connected to the QuickDraw product valves. These products hook up directly to valves 1-4 or 1-6 or 1-9 depending on the QuickDraw model. The system can pull in bulk products automatically as long as the total amount required for that product for the batch is greater than 0.5 gallons on a Venturi (Non-suction) model or 1.0 gallons on a Pump Suction model. Anything that is in powder form or less than the minimum stated above would be considered a manually added product. The process will pause when it gets to these products in the cycle and allow for the operator to use the optional *Swing Down* eductor system available from SurePoint or the operator can use the inductor system on their sprayer, if available, to add these products to the batch. When finished adding a manual product, a tap on the screen tells the controller to continue to the next product). *Do not delay in adding the manual products, as carrier is being pumped at 40-50 GPM during this time. A delay (especially on a small batch) could result in all the carrier being pumped before all the chemicals are added. If there will be a delay, **PAUSE** the batch.*

The recipe information used to create a batch is as follows.

PRELOAD VOLUME: An amount can be entered here if the operator wishes to preload an amount of the carrier before any product is loaded. A warning will be generated if the preload amount is too large for the batch size.

PRODUCT NAME: The name of the product used in the recipe.

RATE: The application rate/acre of each product. The units are set on the Edit Recipe Screen under Volume Units. *The Rate can be changed here for a particular batch.*

ORDER: This is the order that the products get loaded (as determined by the operator). Products are set up in the recipe based on which valve they are hooked up to (i.e. Product 1 is Valve 1, Product 2 is Valve 2 etc). *Products **do not** have to be loaded in valve order. The load order is set on the Recipe screen by the operator and products can be loaded in any order, regardless of valve number, or regardless of whether it is an Automatic or Manual product.* This allows the recipe to call for a manual product first and then go through the bulk automated products and then back to a manual product again or load them in any order the operator chooses.

PRODUCT VOLUME: This column displays the amount of product necessary in the selected totalizer units for that product. This is calculated by taking the number of acres times the rate entered and then converting from the rate units to the totalizer units. For example, if the rate is 32 Oz/Acre, the batch size is 100 Acres, and the totalizing units for the product is in gallons, then the product volume is $32(\text{oz/acre}) * 100(\text{acre}) / (128 \text{ oz/gal}) = 25 \text{ gal}$

TOTAL: This column shows the total amount needed for this batch for this product in the total batch units (either gal or liters). For example, if a batch needs 200 pts of product, then the total will read 25 GAL ($200 / 8 = 25$). *Always check to see that this amount seems reasonable before starting the batch.*

PROD(UCT) RINSE (TIME): This sets the rinse time before each product is batched. If this is set to 3 seconds, the rinse valve will be open for 3 seconds prior to the product valve opening which will rinse the common header for that time period. **The default and minimum time is 3 seconds.**

FINAL RINSE sets a final post rinse time (**default and minimum is 10 sec**). When the last product has been completely batched, the rinse valve will remain open to make sure all products are rinsed out of the system.

Calculation Mode: The information entered on the screen is used to calculate the size of the batch from the recipe that was loaded. There are 4 different ways to calculate batches that can be chosen from the drop-down menu, and they are as follows.

Volume and Application Rate: This setting will be used when filling the sprayer tank full. This uses the **Total Volume** box and the **App(lication) Rate** box to come up with the number of acres needed for this batch. Then all the product amounts are calculated. From this information, the carrier amount is determined by subtracting all the product amounts from the total gallons.

Acres and Application Rate: Use this mode when spraying a known area requiring less than a full sprayer tank. This uses the **Total Acres** box and the **App(lication) Rate** box to calculate how many gallons of product are necessary. Then the number of acres is used to calculate how much of each product is needed for this batch. From this information, the carrier amount is determined by subtracting all the product amounts from the total gallons.

Individual Volume: *This method does no math.* The total amount of each product that needs batched is entered into the column where the rate is normally entered. This amount is entered in the units set up by the Total column. The batch will still be automatically batched out, but the controller does no math on the batch.

Area and Carrier Rate: This uses the **carrier rate** box and the **acres** box. This mode is used if you want to specify how much carrier is going to be applied per acre instead of specifying the overall application rate. The application rate that gets entered into the sprayer is calculated in this case instead of set.

Edit Recipe: The only things that can be changed on the Job Screen are the items in the white boxes. Rate (for each product), Calculation Mode, and Calculation Variables (Total Acres, App Rate, Total Volume) can be changed on the Job Screen. To change other variables, press **EDIT**. Changes made on the Job Screen apply only to the current job and are not permanent changes to the recipe unless **SAVE** is pressed. Changes made on the **EDIT** screen will be for the current batch only unless **SAVE** is pressed. Permanent changes to the recipe will only be saved by pressing **SAVE**.

DUPLICATE: Use this to modify a base recipe with minor changes. The original recipe will remain intact. A new recipe with “DUP” added to the name will be started. The name can be edited and changes can be made to the recipe. Press **SAVE** when finished.

Run: Returns user to the RUN screen (does not start the batch)

Note on Individual Volume: This can be used to finish off a batch or top it off if something isn't right. If more chemical is needed, set that amount of chemical in the Rate column, set Preload Vol at 0. Enter an amount for the Carrier. Start the batch. As soon as the product is mixed in, press **PAUSE**, and terminate the batch. That will get the chemical added with as little water as possible.

If more water is needed, set the Rate on all the products to 0, and enter the amount of water desired in the Carrier: Water column. Run this batch to add the extra water.

At bottom left on Job Screen	→	PRODUCT HOSE RINSE DISABLED	→	PRODUCT HOSE RINSE ENABLED	→	Rinse Setup
------------------------------	---	--	---	---------------------------------------	---	-------------

—See next pages for more information on using the Product Hose Rinse feature to rinse a hose from the tote to the QuickDraw while a batch is running. This feature allows the user to rinse a product hose with clean water while running a batch, while accounting for the chemical in the hose and the water used for rinsing as part of the batch.

Product Hose Rinse can also be used in conjunction with the Bulk Blaster to rinse a tote and include that chemical and rinse water as part of the batch.

Product Hose Rinse

Rinse a product hose with the carrier, while accounting for the chemical in the hose and the carrier used for rinsing as part of the batch.

At bottom left on Job Screen



PRODUCT HOSE RINSE DISABLED



PRODUCT HOSE RINSE ENABLED

Rinse Setup

Length Units: Feet | Diameter Units: Inches

Enter Hose Length and Hose Diameter and check the Rinse Hose box so the chemical in the hose will be accounted for.

	Hose Length (Feet)	Hose Diameter (Inches)	Hose Volume (GAL)	Rinse Hose
Tote1: Atra-V 4L (Atrazine)	11.5	2.0	1.87	<input checked="" type="checkbox"/>
Tote2: NO PRODUCT	0.0	0.0	0.00	<input type="checkbox"/>
Tote3: Slam 54 Extra (glyphosate)	14.5	1.5	1.33	<input type="checkbox"/>
Tote4: Moccasin	0.0	0.0	0.00	<input type="checkbox"/>
Tote5: NO PRODUCT	0.0	0.0	0.00	<input type="checkbox"/>
Tote6: NO PRODUCT	0.0	0.0	0.00	<input type="checkbox"/>

After finishing the setup on this screen, return to the JOB or RUN screen.

Enter the Hose Length and Diameter for each product. Click on the Rinse Hose button(s) to have the hose volume subtracted from what is batched, so it can be added during rinsing.

JOB RUN

After all the products have been added, this screen will appear. See additional instructions on next page.

Product Hose Rinse

NOTE: OPENING VALVES WILL PULL PRODUCT INTO THE BATCH. ENSURE YOU OPEN THE CORRECT VALVE. FOR THE FULL INSTRUCTION SET, CLICK ON THE HELP BUTTON.

Product	Set Point	Actual	Rinse Volume	Valve	Status
Atra-V 4L (Atrazine)	25.0 GAL	23.8	0.0 GAL	Valve 1	100%
Moccasin	3.1 GAL	3.0	0.0 GAL	Valve 4	0%
NO PRODUCT	0.0 GAL	0.0	0.0 GAL	Valve 2	0%
NO PRODUCT	0.0 GAL	0.0	0.0 GAL	Valve 5	0%
Slam 54 Extra (glyphosate)	20.3 GAL	20.2	0.0 GAL	Valve 3	0%
NO PRODUCT	0.0 GAL	0.0	0.0 GAL	Valve 6	0%

PAUSE Batch: 1000.0 GAL Actual: 352.3 GAL Finished

Product Hose Rinse



Scan or Click
for VIDEO

FULL HOSE RINSE

1. Close the valve on the tote / shuttle.
2. Press the valve button that corresponds to the correct product. This will begin sucking product/carrier into the batch. If a hose volume was entered on the Rinse Setup screen, the Product Actual amount will count up until it reaches the SetPoint, after which, all measured liquid will be allocated to the Rinse Volume.
3. Detach the hose from the chemical tote and attach it to the Product Hose Rinse port on the side of the QuickDraw. Leave the other end of the hose attached to the QuickDraw valve stack.
4. Open the Product Hose Rinse port valve and all valves on the product hose.
5. Once you have reached the desired Rinse Volume, press the valve button again to close the valve. Then close the Product Hose Rinse port valve. (Repeat for each hose you want to rinse.)

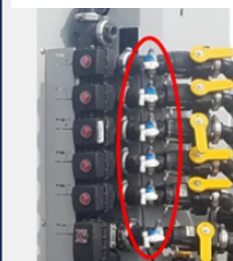
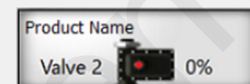

VALVE RINSE (This will rinse the area between the hose valve and the QuickDraw valve.)

1. Close the product hose valve next to the QuickDraw valve stack.
2. Open corresponding 3/8" Rinse Valve.
3. Press the valve button that corresponds to the correct product.
4. Once you have reached the desired Rinse Volume, press the valve button again and close the 3/8" Rinse Valve. (Repeat these steps for each hose that you intend to rinse.)

When all the valves have been correctly positioned, press on the desired Valve on the screen below to open the valve and rinse the hose. Press on the valve to close it when the hose has been rinsed. Press **"FINISHED"** when all hoses have been rinsed. The QuickDraw will advance to top off the remaining carrier. *Note: Once FINISHED has been pushed, you cannot return to Product Hose Rinse.*



Product Hose Rinse

NOTE: OPENING VALVES WILL PULL PRODUCT INTO THE BATCH. ENSURE YOU OPEN THE CORRECT VALVE. FOR THE FULL INSTRUCTION SET, CLICK ON THE HELP BUTTON.

Product	Set Point Actual	Rinse Volume	Product	Set Point Actual	Rinse Volume
Arrow Valve 1 95%	20.0 20.0 GAL	11.7 GAL	Durango Valve 4 0%	10.0 10.1 GAL	0.0 GAL
Bravo Valve 2 0%	20.0 20.2 GAL	0.0 GAL	NO PRODUCT Valve 5 0%	0.0 0.0 GAL	0.0 GAL
Champion Valve 3 0%	15.0 15.0 GAL	0.0 GAL	NO PRODUCT Valve 6 0%	0.0 0.0 GAL	0.0 GAL

Batch: 1200.0 GAL
Actual: 528.9 GAL

Alarms and Warnings (see the next two pages for more Alarms and Warnings)



Active Alarms



Sample Alarms

- Product Valve 1 Failed to Open
- Product Valve 1 Failed to Close
- Product Load Order Duplicated
- Can Not Skip a Number in Product Load Order
- Product 2 Flow Failure
- CAN Bus Valve Failure
- Mass Meter Comm Loss
- CAN BUS Failure

Suction Only Alarms:

- Carrier Holdback can't be more than 50% of Carrier Total After Preload.
- Carrier Holdback not allowed when Carrier Calibration is enabled.

If an Alarm is present, the batch will NOT run. Something must be done to correct the issue causing the Alarm.

Go To Problem
Go To Problem





Active Warnings



Sample Warnings

- Preload Too Large for Batch Size
- Some Automated Products are Set to Batch Less than 0.5 Gal. This May Affect Accuracy
- Product 3 Low Level Alarm
- Air Detected in Mass Meter
- The WIFI password is too short. Must be at least 8 carriers long.
- Some products have Rates but the Valve is Disabled.

If a Warning is present, the batch will run, but the issue causing the Warning should be investigated.

RUN **MENU**

Alarms

A batch will not run if there is an alarm. The issue must be resolved before the batch can be started or resumed.

Product Valve X Failed to Open

Product Valve X Failed to Close

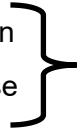

*Be sure valve is plugged in with good connection.
Go to RUN > Manual Controls > open/close valve.
Check Valve Position on Manual Controls screen.*

Product X Flow Failure—

Check Product in Tote, valves open. New tote may need Prime Enabled.

Carrier Flow Failure

Batch Complete, Products Not Complete—*Not all chemicals were added to batch.*

Battery Voltage Low—*Charge battery. Use good battery in QD cabinet.*

ESTOP has been enabled. Disable ESTOP to return to normal operation.

Mass Meter Comm Loss—*See Troubleshooting section, number 1 and number 12.*

CANNOT DUPLICATE A LOAD ORDER

CANNOT SKIP A LOAD ORDER

Suction Only

Carrier Throttling Valve Failed to Open

Carrier Throttling Valve Failed to Close

Carrier Holdback can't be more than 50% of Carrier Total after PreLoad.

Carrier Holdback not allowed when Carrier Calibration is enabled.

Multi Carrier Only

Carrier Valve X Failed to Open

Carrier Valve X Failed to Close

TOTAL CARRIER VOLUME HAS NOT BEEN ALLOCATED

MORE CARRIER HAS BEEN ALLOCATED THAN IS IN THE RECIPE

Can Not Have Duplicate Load Orders in Carrier Setup

Can Not Skip a Load Order in Carrier Setup

Carrier to be used as Preload has not been selected

Carrier Selected for Preload has no Rate and/or Load Order

Preload is larger than the total amount for the selected Carrier

Carrier must have a Rate if it has a Load Order

A Carrier must be selected if it has a Load Order

See Troubleshooting section of this manual.

See support.SurePointag.com website.

Warnings

A batch will run if there is a Warning, but the issue should be looked at as it could lead to a more serious problem. The warnings related to how much product is available are dependent on the inventory level being set correctly when a tote is attached. Be sure that the inventory level reported on the QuickDraw matches what is actually in the tote.

Carrier Level is Below the Low Level Setpoint

Product X Level is Below the Low Level Setpoint

Carrier Level is Below What is Needed to Complete the Batch

Product X Level is Below What is Needed to Complete the Batch

Check the product level in the tote.

Check the Inventory Level for that product in QD.

If tote is low, can empty tote, PAUSE batch, hook up new tote, and RESUME.

Some Automated Products are Set to Batch Less than 0.5 Gal. This may affect accuracy.

PreLoad Too Large for Batch Size—Reduce PreLoad amount for Batch.

Some Products have a Load Order and Rate but no Selected Product.

Some Products have Rates but No Load Order

Some products have Rates but the Valve is Disabled.

Air Detected In Mass Meter

Excessive Air In Mass Meter

Tighten all fittings and clamps from Tote to Mass Meter on QD. This could also happen when a new tote is connected or when a tote is near empty.

The Hose Volume for at least one of the Totes is Larger than the Batch Total for that Tote

Some Carriers Have Rates but No Load Order

Some Carriers are Set to Batch Less than 20 Gal. This May Affect Accuracy.

Carrier Volume May be Too Low to Guarantee Batch Success due to Carrier Calibration.

After Preload, more than 65% of the batch needs to be Carrier to Guarantee Batch Success
May be an issue when App Rate is very low and chemical concentration is high.

Carrier Calibration is not possible due to Low Carrier Setpoint.

Carrier Failed to Calibrate

The WIFI password is too short. The Password must be at least 8 characters long.

MultiCarrier Only

Carrier X Level is Below the Low Level Setpoint

Carrier X Level is Below What is Needed to Complete the Batch

Carrier X Calibration is not possible due to Low Carrier Setpoint.

Carrier X Failed to Calibrate

Check the carrier level in the tank.
Check the Inventory Level for that carrier in QD.

See Troubleshooting section of this manual.

See support.SurePointag.com website. See QuickDraw videos at youtube.

Manual Products

Manual Products are products in a batch that are **not** added through one of the automatic valves. These products are added through the optional Swing Down eductor or through the sprayer's inductor or are added directly to the sprayer tank. Manual products (up to 5) are included in the recipe and appear in the historical batch record. Manual products may be dry or powder products, or they may be liquid products that do not come in bulk containers or that will have less than 0.5 gallons (1.0 gal on Pump Suction model) in a batch. (Liquid products that are in a tote connected to one of the valves, but which are scheduled to have less than 1 gallon in a batch, may be run through the automatic product part of the recipe, but it is recommended they be added as a manual product.)

As the recipe is put together, the **Order** of the manual product(s) is entered. The manual product(s) can be set up to load in whatever order the operator desires. When the batch is being run, the message shown below will appear on the controller screen and on the iPad QuickDraw App. **The carrier will continue to be pumped at 40-50 GPM while the manual product is added.**

When it is time to add a Manual Product, the screen below will appear. On the right side it will show how many bags (or jugs) need to be added. As each bag (or jug) is added, touch a bag on the screen to turn it green to show it has been added.

Add the amount of product called for in the recipe, and then press **Required Amt Added**. The QuickDraw will continue to complete the batch after the operator presses **Required Amt Added**. If an amount different than the Total Product Required is used, enter that amount in **Actual Product Loaded** and press **Finished**.

*If, for some reason, there is going to be a substantial delay in adding the manual product, press **PAUSE** on this screen to stop the carrier flow until the manual product can be added. Then, the batch can be **RESUMED**.*

Manually Added Product

AMS

Total Required: 170.0 lbs

Actual Product Loaded: 0.0 lbs

Required Amt Added

Finished

Container Size: 51.0 lbs
Added/Needed: 0.00/3.33

Touch a bag as each one is added to keep track of what has been added.

0.0/16.98 lbs

2 Inch Venturi-De

PAUSE

Batch: 1,000.0 GAL

Actual: 31.4 GAL

Pre-treating Carrier Water



For users who are mixing batches that contain AMS and/or other treatment for the water carrier, it is possible to pre-mix this in the water and not have to do that step for every batch. To do the following process, the QuickDraw must be plumbed so that water can be pulled from the ground source tank and circulated through the QuickDraw to the trailer tank(s).

A recipe may even be set up for the pre-mixing process. Create the recipe with the products that will be added to the water for the pre-treating. Run this batch and load it into the carrier supply tank.

When using pre-treated water, use the same recipe that you would use if you were going to manually add the AMS or other treatment. Set up the AMS or other treatment as a Manually Added Product with Load Order of 1. When the batch gets to the point where it wants this Manually Added Product, simply push the button to say *Required Amt Added*. The batch will continue mixing the automatic products. With the AMS or other treatment on the recipe as a Manually Added Product, it will be shown in the Historical Batch Report.

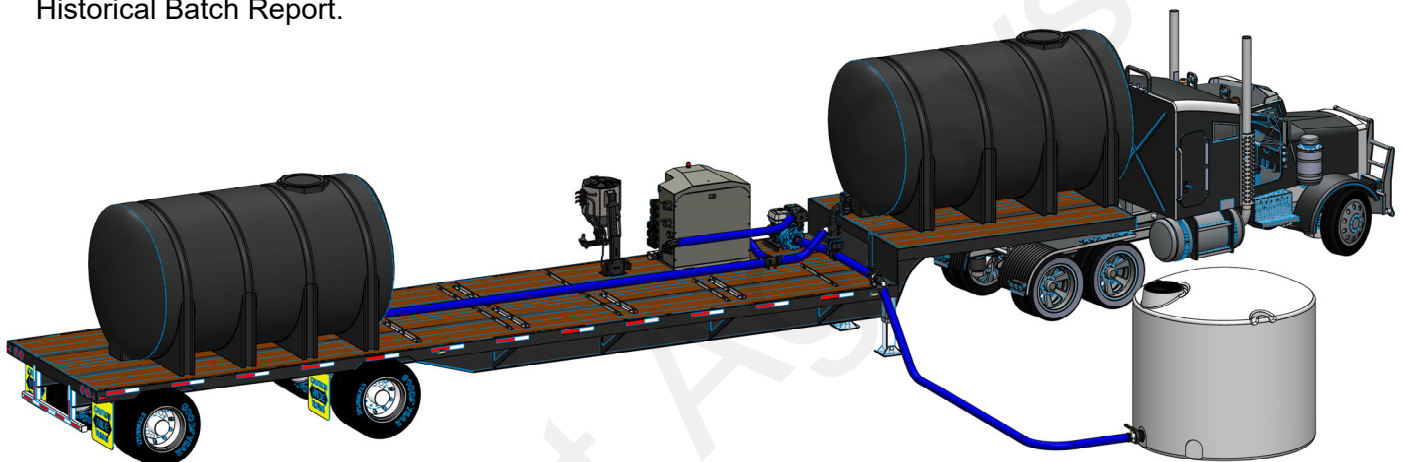

Manually Add Product

AMS

Total Product Required	510.0	lbs
Actual Product Loaded	<input type="text" value="0.0"/>	lbs

Select which valve to have open: the 2-inch Venturi or the 3-inch Valve.

Batch: 3000.0 Gal Actual: 225.0 Gal

NOTICE

When filling a tank with Pretreated Water, be sure to label the tank so it is clear that the tank contains treated water.



Creating a New Recipe

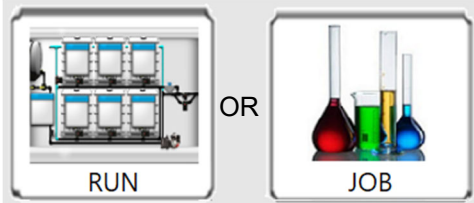

Recipe:

NEW

CREATE RECIPE

NAME:



When the name is SAVED, the controller will go back to the screen where the NEW recipe process was initiated, either the RUN screen or the JOB screen. If it takes you back to the RUN screen, go to the JOB screen and press EDIT or one of the blue tote labels to bring up this screen.

PreLoad Vol GAL

Recipe:

Calculation Mode

Prod Rinse Sec

Final Rinse Sec

	Carrier	Tote 1	Tote 2	Tote 3
	NO PRODUCT	NO PRODUCT	NO PRODUCT	NO PRODUCT
Rate	<input type="text" value=".0"/>	<input type="text" value=".00"/>	<input type="text" value=".00"/>	<input type="text" value=".00"/>
Rate Units	<input type="text" value="GPA"/>	<input type="text" value="GAL/Ac"/>	<input type="text" value="GAL/Ac"/>	<input type="text" value="GAL/Ac"/>
Load Order		<input type="text" value="0"/>	<input type="text" value="0"/>	<input type="text" value="0"/>
Volume Units	<input type="text" value="GAL"/>	<input type="text" value="GAL"/>	<input type="text" value="GAL"/>	<input type="text" value="GAL"/>
Volume		<input type="text" value=".0"/>	<input type="text" value=".0"/>	<input type="text" value=".0"/>
Total GAL	<input type="text" value=".0"/>	<input type="text" value=".0"/>	<input type="text" value=".0"/>	<input type="text" value=".0"/>

Total Acres Total Volume GAL App Rate GPA

RUN **JOB**

SAVE NEW SELECT RECIPE

From here, creating a RECIPE is similar to editing a recipe, as shown on the following pages. Click on a blue tote label to enter or select a product for that tote. Enter the RATE, RATE UNITS, LOAD ORDER, etc.

Use the arrows to right (or left) of the blue tote buttons to move to other totes (and manual products).

Press SAVE to save the recipe.

Edit Recipe Screens

Access these screens by pressing the **EDIT** button at the bottom of the **JOB** screen,



EDIT

or by pressing one of the **BLUE** Tote Name buttons on the **JOB** screen.

Tote1: Atra-V 4L (Atrazine)



SCAN ME

Recipe:

PreLoad Vol GAL

Calculation Mode

Prod Rinse Sec

Final Rinse Sec

	Carrier Water	Tote1 Atra-V 4L (Atrazi...	Tote2 NO PRODUCT	Tote3 Slam 54 Extra (g...
Rate	9.3	<input type="text" value="1.00"/>	<input type="text" value="0.00"/>	<input type="text" value="26.00"/>
Rate Units	GPA	Qt/Ac	GAL/Ac	fl. Oz/Ac
Load Order		<input type="text" value="2"/>	<input type="text" value="0"/>	<input type="text" value="3"/>
Volume Units	GAL	GAL	GAL	GAL
Volume		25.0	0.0	20.3
Total GAL	934.6	25.0	0.0	20.3

Total Acres Volume GAL App Rate GPA

RUN **JOB**

SAVE
NEW
SELECT RECIPE

ARROW to move to more Totes.

Recipe:

PreLoad Vol GAL

Calculation Mode

Rate

Rate Units

Load Order

Volume Units

Volume

Total GAL

	Tote4 Moccasin	Tote5 NO PRODUCT	Tote6 NO PRODUCT	Man. Prod1 AMS
Rate	<input type="text" value="4.00"/>	<input type="text" value="0.00"/>	<input type="text" value="0.00"/>	<input type="text" value="17.00"/>
Rate Units	fl. Oz/Ac	GAL/Ac	GAL/Ac	lbs/100
Load Order	<input type="text" value="4"/>	<input type="text" value="0"/>	<input type="text" value="0"/>	<input type="text" value="1"/>
Volume Units	GAL	GAL	GAL	lbs
Volume	3.1	0.0	0.0	170.0
Total GAL	3.1	0.0	0.0	17.0

Total Acres Volume GAL App Rate GPA

RUN **JOB**

SAVE
NEW
SELECT RECIPE

ARROW to move to more Manual Products.

The **EDIT RECIPE** screens can be used to create a new recipe or edit an existing recipe. All the same information that was on the job screen above shows up on this screen also, though everything on this screen can be edited. A recipe can be edited on these screens and those changes are active for the recipe until a recipe is loaded, but those changes are not saved permanently unless the **SAVE** button is pressed. Each column represents one product and the settings that are necessary to batch that product.

On the top line, press on the box beside **Recipe** to select an existing recipe.

PRELOAD VOLUME: An amount can be entered here if the operator wishes to preload an amount of the carrier before any product is loaded. A warning will be generated if the preload amount is too large for the batch size.

PROD RINSE: This sets the rinse time before this product is batched. For example, if this is set to 3 seconds, the rinse valve will be open for 3 seconds prior to the product valve opening which will rinse the common header for that time period. The default and minimum is 3 seconds. It can be set for a longer time.

FINAL RINSE: After the last product has been completely batched, the rinse valve will remain open for this many seconds to make sure all products are rinsed out of the system (default/minimum is 10 seconds).

Blue portion of product box displays the **Tote Number and product name**. Pressing this part of the product column allows selection of a new or different product. Press the arrow to the left or right of the blue boxes to move to a screen showing the other totes or manual products.

RATE: The application rate/acre of each product.

RATE UNITS: The units the rate above is entered in. Tap on the box to bring up the pull-down options. Options available are: GPA, fl oz/ac, Pt/Ac, qt/ac, lbs/ac dry, L/ac, mL/ac, lbs/100, pt/100, qt/100, gal/100, oz/ac dry, g/ac, kg/ac, g/100, kg/100, mL/100, or L/100. (lbs/100 is for a product that will be added as lbs of product per 100 gallons (liters) of mix.)

LOAD ORDER: This is the order that the products get loaded (as determined by the operator). Products are set up in the recipe based on which valve they are hooked up to (i.e. Product 1 is Valve 1, Product 2 is Valve 2 etc.). *Products do not have to be loaded in valve order. The load order is set here by the operator. Products can be loaded in any order, regardless of valve number, or regardless of whether it is an Automatic or Manual product.* This allows the recipe to call for a manual product first and then go through the bulk automated products and then back to a manual product again or load them in any order the operator selects here.

VOLUME UNITS: These are the units that will be used for the VOLUME tally. The controller will only allow selection of units that make sense with previous selections. These units will be used in the Historical Log for this batch.

VOLUME: This row displays the amount of product necessary in the selected totalizer units for that product. This is calculated by taking the number of acres * rate entered and then converting from the rate units to the totalizer units. For example, if the rate is 32 Oz/Acre, the batch size is 100 Acres, and the totalizing units for the product is in gallons, then the product volume is $32(\text{oz/acre}) * 100(\text{acre}) / (128 \text{ oz/gal}) = 25 \text{ gal}$.

TOTAL GALLONS: This column shows the total amount needed for this batch for this product in the total batch units (either gal or liters). For example, if we take the 200 pts from the example in PRODUCT VOLUME and convert it to GAL, then the total will read 25 GAL.

Edit Recipe Help Screen

Recipe:

Clicking on Recipe Name allows you to Select, Delete, Edit, or Create a Recipe.

Calculation Mode:

Depending on the selected mode, the user can change acres, volume, and app rate to calculate load size and product totals.

Tote:

Touching one of the Totes gives the user the ability to change the product corresponding to that Tote.

Rate:

The amount (in the selected Rate Units) that will be applied. Click on the Rate box to set the rate for that product.

Rate Units:

Select the units to be used for the application rate.

Load Order:

Specifies the order in which the products will be loaded in this recipe.

Volume Units:

Set the units to be used for calculating the amount of product used. This amount will be shown in Volume.

Prod Rinse:

The amount of time that the product valve manifold will be rinsed between products.

Final Rinse:

The amount of time that the product valve manifold will be rinsed after the final product has been added.

Acres/Volume/App Rate:

Change these to adjust product and load totals.



Creating a Recipe on the iPad and Transferring to QD

Most of the same process described in the preceding pages can be used to create a Recipe on the iPad while not connected to the QuickDraw (for example, in the office) and then transfer it to the QuickDraw later. Scan the QR code to the right to see a short video on the process of creating a recipe on the iPad and transferring it to the QuickDraw.

More information on setting up the iPad to communicate with the QuickDraw appears later in this manual.



Tote Setup Screen (Product Setup)

On the Run Screen, press on the Tote to be set up. →

- 1: Atra-V 4L (Atrazin)
- 3: Slam 54 Extra (gly)
- 4: Moccasin

If the Inventory amounts below are filled in when the tote is connected, the current volume in the tote will be shown by the green bar on the RUN screen.

Atra-V 4L (Atrazine)

Press on a white box to enter the information.

Verify that this tote and product are connected to this valve. Tote 1

Name:

EPA ID:

Enter EPA ID here for batch history report.

Default Units: Qt/Ac

Inventory ID:

Full Amount: GAL

Amount Left: GAL

Empty Alarm: GAL

Current Recipe Specific Information

Amount Required: 25.0 GAL

App Rate: 1.00 Qt/Ac

Load Order: 2

Set **Amount Left** in tote when connecting a tote.

Set **Empty Alarm** to get a warning when tote gets low.

Press **Prime Disabled** to change to **Prime Enabled** when a new tote is connected or a tote has run empty.

RELOAD
PRIME DISABLED
JOB
RUN

Press Arrow to move to other tote. →

NAVIGATION

CREATE PRODUCT

Name:

NEW

NAME:

EPA ID:

DEFAULT UNITS:

SAVE
CANCEL

- GPA
- fl. Oz/Ac
- Pt/Ac
- Qt/Ac
- lbs/Ac dry
- L/Ac
- mL/Ac
- lbs/100
- Pt/100
- Qt/100
- Gal/100
- Oz/Ac dry
- g/Ac
- kg/Ac
- g/100
- kg/100
- mL/100
- L/100

Carrier Setup Screen

Water

On the RUN screen, press on the blue Carrier tote label to bring up this screen. Add a new carrier or change the carrier by pressing on the **Name** box.

Water Carrier

Name:

Default Units:

Full Amount: GAL

Amount Left: GAL

Empty Alarm: GAL

Current Recipe Specific Information

Amount Required: 1114.6 GAL

App Rate: 15.0 GPA

Carrier Flowmeter Calibration (using Mass Meter)

FLOW CAL OFF—Press for **FLOW CAL ENABLED**. When the batch is started, the carrier solution will flow through the Mass Meter as well as through the Carrier Flow Meter so that the Carrier Flow Cal can be calibrated. This is especially important when using Multiple Carriers to verify accurate measurement of each carrier.



The Carrier Tote on the Run Screen will show the “CALIBRATING” message while the batch is running.

When the batch is completed the Carrier Flow Cal (Pulses/Gal) for that carrier will be adjusted based on this calibration process.

Verify accurate carrier measurement for future batches.

The Carrier Flow Cal can always be adjusted manually, if needed. If the carrier is routinely ending up short or long, adjust the Pulses/Gal for the carrier.

Increase the Flow Cal (Pulses/Gal) if more carrier is needed.

Decrease the Flow Cal if less carrier is needed.

See the navigation path on the next page or watch the video.



SCAN ME

EDIT CARRIER (Navigation—Press on indicated boxes): Use to edit Pulses/Gal for carrier flowmeter calibration. Carrier Flow Cal (pulses/gal) must be adjusted here.

Water

381.6 GAL

381.4

43.0 GPM

Water Carrier

Name: Water

SELECT CARRIER

Number of Results: 5

FILTER: Sort Direction:

Name	EPA ID	Pulses/Gal
NO PRODUCT		
Fert 1		91.0
Fert 2		91.0
Fert 3		91.0
Water		91

EDIT CARRIER

NAME:

EPA ID:

Pulses/Gal: *Increase the Flow Cal (Pulses/Gal) if more carrier is needed. Decrease the Flow Cal if less carrier is needed.*



Advanced Settings Screen (includes Carrier Blending)

Don't mess with these unless you know what you're doing.

Carrier Meter Select: Press to toggle from Arag to Seametrics (default and standard on QD3000 is Arag).

Pressure Input: Press to toggle from QD3 to QD2 (if using this controller on an older Quick Draw 2 model)

Reset to Factory Defaults: You may not want to do this.

Number of Carriers: Pulldown menu to select from 1 to 4 carriers.

Remote Data Selection: Default is Email History

Language: Select desired

Automated Products: Enter 4 or 6 or 9.

Select Venturi or Pump Suction: Toggle to select

Pulses/Gal: The default is 91 for the Arag carrier flow meter. The default for the Seametrics flowmeter is 13.7. The number here will be the default setting if no carrier is selected. To change the flow cal for a specific carrier, go to that carrier and edit the Pulses/Gal (see page 32). Changing the number here will not change a carrier that has already been set up.

Product Auto-Tuning: Typical is Green. This will enable the QD to automatically tune the closing time on the product valve if it consistently overshoots or undershoots the desired amount.

Close 2" Valve During Rinse: Typically Red. Would be set to Green if your system has a QD3000 controller on an older QD2 cabinet.

Advanced Settings > Diagnostics

Advanced Settings

DIAG

Do not use this page without direction from SurePoint Tech Support. You can mess things up from here if you don't know what you are doing.

Diagnostics

IP Settings	Files	
Modem Data	View Vars	
	NV Memory	I/O Test
Web History	Load Example Recipe	

Files: Used/Avail: 67,072/512,000 bytes

BACK System Settings MENU

IP Settings

IP Settings

WIFI	Ethernet
IP Address: <input type="text" value="192.168.1.140"/>	IP Address: <input type="text" value="192.168.1.135"/>
Net Mask: <input type="text" value="255.255.0.0"/>	Net Mask: <input type="text" value="255.255.0.0"/> COMM IP
Gateway: <input type="text" value="192.168.1.99"/>	Gateway: <input type="text" value="192.168.1.99"/> <input type="text" value="192.168.1.135"/>
DNS: <input type="text" value="192.168.1.11"/>	DNS: <input type="text" value="192.168.1.11"/>
<input type="button" value="SAVE"/>	<input type="button" value="SAVE"/>

*These Settings should not need changed. Doing so may cause severe problems.
Contact your QuickDraw dealer or SurePoint Ag Systems for technical support.*

Files

DELETE

<input type="button" value="Grower"/>	<input type="button" value="Operator"/>	<input type="button" value="Recipe"/>
<input type="button" value="Farm"/>	<input type="button" value="Machine"/>	<input type="button" value="Product"/>
<input type="button" value="Field"/>	<input type="button" value="Crop"/>	
<input type="button" value="HISTORY"/>	<input type="button" value="Pest"/>	<input type="button" value="All"/>

*DO NOT USE these buttons unless you are absolutely sure you want to delete all of the entries in that field.
Only use at the direction of qualified tech support.*

Import from USB

Carrier Blending (Multiple Carrier) Setup Screen

System must be set up for more than 1 carrier (see page 33). On the Run Screen, tap the blue Carrier tote label.

MULTIPLE PRESS: Carrier

App Rate GPA
 Volume GAL

CARRIER SETUP

Carrier Calc Mode
 Volume ▼

TOTAL CARRIER VOLUME HAS NOT BEEN ALLOCATED

PreLoad Vol GAL

Name	Load Order	Rate	Inv.	Use as Preload	
Carrier 1: Water	<input type="text" value="4"/>	<input type="text" value="299.9"/> GAL		<input checked="" type="checkbox"/>	Set To Balance
Carrier 2: Fert1	<input type="text" value="1"/>	<input type="text" value="100.0"/> GAL		<input type="checkbox"/>	Set To Balance
Carrier 3: Fert2	<input type="text" value="2"/>	<input type="text" value="249.9"/> GAL		<input type="checkbox"/>	Set To Balance
Carrier 4: Fert3	<input type="text" value="3"/>	<input type="text" value="199.9"/> GAL		<input type="checkbox"/>	Set To Balance

SAVE

Carrier in Recipe: 934.6 GAL
 Carrier Still Needed: 84.9 GAL

JOB

RUN

Carrier Setup (for Carrier Blending) Help Screen

Carrier Calc Mode: Select how to enter the amount of each carrier to use. Pulldown menu to select *Percentage, Volume, or Application Rate*.

Carrier Name: Press on the Carrier Name box to Select/Edit/Create New Carrier to be used.

Load Order: Specify the order in which the carriers will be loaded. Carriers must have a Load Order to be included in the batch. Any Carrier without a Load Order will be ignored during batching.

Amount: The amount of each Carrier to be included in the Recipe. Units will match Carrier Calc Mode selected above.



Press on this arrow to go the Inventory/Alarm screen for the selected Carrier. Press the arrow on the Inventory screen to move from one carrier to another. Press **CARRIERS** to return to the Carrier Setup screen.

Use as Preload: Check the box to indicate which Carrier should be used for the Preload.

Carrier in Recipe: This value indicates the total amount of Carrier in the current Recipe.

Carrier Still Needed: This value indicates how much Carrier is still needed to account for the total amount in the Recipe.

Set to Balance: These buttons are only visible when “Carrier Still Needed” is not 0. Pressing on one of these will allocate all of “Carrier Still Needed” to that Carrier.

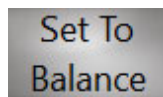

SAVE: Press SAVE to save the changes.

Press on a blue Carrier tab to bring up this screen to Select / Edit / or Create a New carrier. Press on a Carrier Name, then Press EDIT to change the Name, EPA ID, or Pulses/GAL.

SELECT CARRIER

Number of Results: 5

FILTER: Sort Direction:

Name	EPA ID	Pulses/Gal
NO PRODUCT		
Fert 1		91.0
Fert 2		91.0
Fert 3		91.0
Water		91

EDIT CARRIER

NAME:

EPA ID:

Pulses/Gal: Adjust Pulses/GAL if necessary for better accuracy.
 INCREASE this number if more product is needed.
 DECREASE this number if less product is needed.

CARRIER SETUP

App Rate GPA

Volume GAL

Carrier Calc Mode:

TOTAL CARRIER VOLUME HAS NOT BEEN ALLOCATED

Name	Load Order	Rate	Inv.	Use as Preload	PreLoad Vol	Set To Balance
Carrier 1: Water	<input type="text" value="4"/>	<input type="text" value="2.98"/> GAL/Ac	<input type="button" value="→"/>	<input checked="" type="checkbox"/>	<input type="text" value="100.0"/> GAL	<input type="button" value="Set To Balance"/>
Carrier 2: Fert1	<input type="text" value="1"/>	<input type="text" value="1.00"/> GAL/Ac	<input type="button" value="→"/>	<input type="checkbox"/>		<input type="button" value="Set To Balance"/>
Carrier 3: Fert2	<input type="text" value="2"/>	<input type="text" value="2.50"/> GAL/Ac	<input type="button" value="→"/>	<input type="checkbox"/>		<input type="button" value="Set To Balance"/>
Carrier 4: Fert3	<input type="text" value="3"/>	<input type="text" value="2.00"/> GAL/Ac	<input type="button" value="→"/>	<input type="checkbox"/>		<input type="button" value="Set To Balance"/>

Carrier in Recipe: GAL/Ac

Carrier Still Needed: 0.82 GAL/Ac



Carrier Still Needed does not equal 0. Add amounts to one or more Carriers or press "Set to Balance" to allocate carrier needed to that Carrier.

System Settings

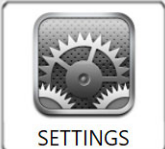

System Settings OR MENU  SCAN ME

System Settings 1

Hide History Full Alarm <input checked="" type="checkbox"/>	Default lbs/Gal 10.0	Manual Product Valve Select 2 Inch Venturi-Default
Grower/Farm/Field Tree <input checked="" type="checkbox"/>	Units English	Kill Pump During Pause <input checked="" type="checkbox"/>
Shuttle Inventory Alarms <input checked="" type="checkbox"/>	Pump Start Mode Momentary Start-Default	Carrier Valve Control Blending
Carrier Inventory Alarms <input checked="" type="checkbox"/>	Pump Start Time 5.0 Sec	ARROW for page 2: Valve Close Time Purge Time DISPLAY SLEEP INACTIVE SHUTDOWN

↓ Battery Voltage: 12.08 Volts
Press for **Advanced Settings**

Date Format
Month/Day/Year

Time Date
1 : 08 : 21 AM 1 / 8 / 2021

Remote Settings RUN MENU

Hide History Full Alarm: If ENABLED, the system will overwrite old history records without warning when the history is full. The History will hold 100 batches. Batch number 101 will overwrite batch number 1.

Grower/Farm/Field Tree: If ENABLED, the user will only see Farms associated with the current Grower, and Fields associated with the current Farm when selecting Farms and Fields. If DISABLED, the user will be able to see all the Farms and Fields while selecting.

Shuttle Inventory Alarms and Carrier Inventory Alarms: If ENABLED, the screen will show a warning when a batch is set up if the inventory of that product or carrier is below what is needed for that batch. For this to work, the inventory of the product tote or carrier tank must be updated each time a new tote is connected or a tank is refilled. If DISABLED, there will be no warning before a batch starts, but flow alarms will activate and the system will pause the batch if the tote or tank runs empty and flow is not detected.

Battery Voltage: Shows the voltage reaching the controller from the battery. Press in the space to the left of Battery Voltage to go to the Advanced Setup screen (see page 33).

Date Format: Select format from pull-down menu.

Time Set / Date Set: This is the time / date that will be recorded in the batch history for each batch. Click on each box in the Time and each box in the Date to set.

Default lbs/Gal: 10 (This is used to convert dry products into an equivalent liquid volume)

Units: Select English or Metric.

Pump Start Mode: When set as **Momentary Start**, the pump-start output is on for “**Pump Start Time**” seconds when the batch is started. When set to **Maintained Start**, the pump start output is on as long

as the batch is active. *Maintained* is the correct choice for hydraulic pumps and probably the best choice for electric, but it depends on the user's motor control center. If the motor has a start-stop push-button setup, *Momentary* may need to be the setting.

Carrier Throttling Valve % Open: Default is **75**. Used only on Pump Suction systems. This will close the carrier valve to the designated percentage to create more suction when product is being pulled into the batch. Decrease this number if you need to use less carrier to get all the chemicals in a batch.

Manual Product Valve Select: This determines which valves are open and closed when adding Manual Products to batch. Default and typical setting is **2 Inch Venturi** for a Venturi system. To set the QuickDraw in bypass mode, select 3 Inch Valve.

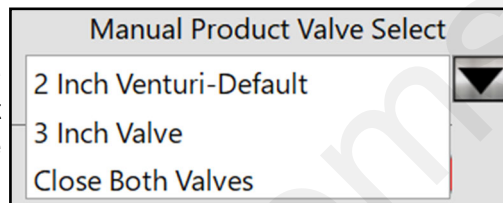

Kill Pump During Pause: Default is Disabled (Red X). Change to Enabled (Green checkmark) if you want to kill the pump anytime the Batch is Paused.

Carrier Valve Control: Only shows when system is set for more than 1 carrier. Default is Blending. Select Manual if you want more than one Carrier Valve to open when a Batch begins.

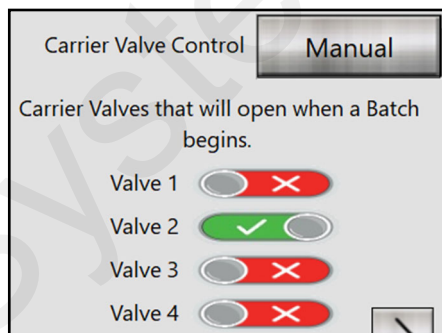

System Settings 1 Help Screen

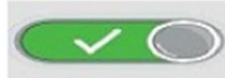

= ENABLED



= DISABLED

Hide History Full Alarm: If ENABLED, the system will overwrite old history records without warning once the history file is full.

Grower/Farm/Field Tree: If ENABLED, the user will only be able to select Farms associated with the current Grower and Fields associated with the current Farm. If DISABLED, the user will be able to select all Farms and Fields.

Shuttle Inventory Alarms/Carrier Inventory Alarms: Determines whether or not the Inventory/Empty warnings are ENABLED. If DISABLED, flow alarms will still activate, and the system will pause the batch if flow is not detected.

Date Format: Allows the user to select which order the Day, Month, and Year are displayed.

Date/Time: The user can set the correct data and time to be used when creating history records. (If the system has internet access, either via cellular modem or LAN, the time will be set automatically. The Time Zone may need to be set based on location.)

Default lbs/Gal: This setting is used to convert dry products into an equivalent liquid volume. The default is 10.0.

Units: US Imperial vs Metric units.

Pump Start Mode/Pump Start Time: When set to Momentary Start, the pump start output will be on for "Pump Start Time" seconds when the batch is started. When set to Maintained Start, the pump start output will be on for the duration of the batch.

Carrier Throttling Valve % Open (Suction Only): While the QuickDraw is adding products, the Carrier valve will close to this position to create more suction on the products.

System Settings 2

System Settings 2

Product Valve

Valve	Status	Close Time
Valve 1	ENABLED	3.20 Sec
Valve 2	ENABLED	1.50 Sec
Valve 3	ENABLED	1.50 Sec
Valve 4	ENABLED	1.50 Sec

Boost Pump: DISABLED

Purge Time: 0.0 Sec

Display Sleep: ENABLED, Sleep Time: 10 Min

Inactive Shutdown: ENABLED, Inactive Shutdown Time: 60 Min

Carrier Valve

Valve	Status	Close Time
Valve 1	ENABLED	8.00 Sec
Valve 2	ENABLED	8.00 Sec
Valve 3	ENABLED	8.00 Sec
Valve 4	ENABLED	8.00 Sec

Legend:
 ENABLED (Green checkmark)
 DISABLED (Red X)

Hose Purge Cycle: An optional accessory that will use compressed air to automatically purge the hose from the QuickDraw to the sprayer after each batch is run.

If the optional "Hose Purge Cycle" is installed set the Purge Time (generally between 5 and 10 seconds). Adjust as necessary for best purge.

Buttons: Advanced Settings, Remote Settings, RUN, MENU

Product Valves: Select DISABLED to disable that valve and to prevent it from opening even if a recipe calls for that valve. This may be needed to allow a batch to run even if one of the valves is not operating.

Valve Close Time: Use this to fine-tune the product valves shutoff to hit the Target. This is the amount of time before the Target amount is reached that the valve will start to close. If the batch is overshooting the Target, increase this time so the valve will begin shutting sooner. If the batch is undershooting the Target, decrease this time so the valve will stay open longer before shutting. The default value for a 1" valve is 1.5 seconds. The default for a 1 1/2" valve is 3.2 seconds.

Boost Pump: (Not used very often) This selects the product during which you would like the optional Boost Pump to be active. Extra harnessing is needed for this option. Typically will be DISABLED, unless using the Boost Pump option.

Purge Time: (if this option is installed): Sets the duration of the Hose Purge cycle at the end of a batch. If Purge is not installed, this should be 0.0.

Display Sleep / Sleep Time: When ENABLED, the display will go to sleep after "Sleep Time" seconds of inactivity to conserve battery power. To wake the display, touch the screen or push the power button.

Inactive Shutdown: If ENABLED, the controller will shut down if it is inactive for the time set in **Inactive Shutdown Time** to save battery power.

Advanced Settings: Press to go to the Advanced Settings screen (see page 33)

Remote Settings: Press to go the Remote Communications Setup screen.

RUN: Press to go the Run Screen (will not start a batch).

MENU: Press to return to the Menu Screen.

System Settings 2- Help Screen



= ENABLED



= DISABLED

Product Valve/Carrier Valve: Select DISABLED to disable the valve. This may be necessary if a valve is malfunctioning and/or not communicating with the controller. When DISABLED, the valve will be ignored, even if the recipe calls for that valve.

Valve Close Time: This is the amount of time before the Target amount is reached that the valve will start to close. If the batch is overshooting the Target, increase the time so the valve will begin shutting sooner. If the batch is undershooting the Target, decrease the time so the valve will stay open longer. The default value for a 1" valve is 1.5 seconds. The default for a 2" valve is 3.2 seconds. The default for a 3" carrier valve is 8 seconds.

Boost Pump (if installed): This selects which product has the optional Boost Pump. If no Boost Pump is present, this should be set to DISABLED.

Purge Time (if installed): This sets the duration of the Hose Purge cycle at the end of a batch. If Purge is not installed, this value should be 0.0.

Display Sleep/Sleep Time: When ENABLED, the display will go to sleep after "Sleep Time" seconds of inactivity. This is intended to conserve battery power. To wake the display, touch the screen or push the power button.

Inactive Shutdown/Inactive Shutdown Time: When ENABLED, the QuickDraw will power down after "Inactive Shutdown Time" seconds of inactivity.

Purge Active Screen

Recipe: Corn Pre 2021

PRELOAD VOLUME
50.0 GAL

Purge

Purge Active

Purge Time 6.2 Sec

CANCEL

MANUAL PRODUCTS
AMS 170.0/170.0

Manual Controls PAUSE BATCH ID 38 - 121020 BATCH: 1000.0 GAL ACTUAL: 986.2 GAL PRESSURE: 15.8 PSI BATCH TIME: 6.4 MIN MENU

Remote Communications Setup

MENU
System Settings
Remote Settings

Remote Settings

Remote Login

User Name:

Remote Password:

QuickDraw ID:

IP Address: 192.168.1.135

Net Mask: 255.255.0.0

Gateway: 192.168.1.99

DNS: 192.168.1.11

COMM IP

192.168.1.135

Wifi Settings



User Name:
Password:
QuickDraw ID:
These must be entered on the iPad app > SETTINGS > REMOTE SETTINGS.
At least one of these must be changed from the Default Settings (for better security).

Batch Complete Email

Batch Completed Report Email Addresses

Email 1:

Email 2:

Email 3:

WIFI
System Settings
RUN
MENU

iPad

Wifi Settings

Scan for Wifi

Wifi Connection

Create QuickDraw Wifi

IP Settings

IP Address: 192.168.1.140

Net Mask: 255.255.0.0

Gateway: 192.168.1.99

DNS: 192.168.1.11

This IP Address must be entered in the iPad app: SETTINGS > REMOTE SETTINGS > WI-FI IP

QuickDraw Wifi

SSID:

WiFi Password:

QuickDraw Wi-fi

SSID:

PASSWORD:

These can be changed by the user, if desired.

On the iPad, go to SETTINGS > Wi-Fi > Choose a Network > Select the network shown in the SSID box. Enter the Password shown in the Password box.

Remote Wifi

SSID:

WiFi Password:

QuickDraw Wifi Active...Network Name: QuickDraw

Remote Settings
RUN
MENU



Wifi Settings

Wi-fi Connection:

This is used to determine whether the QuickDraw will connect to an existing Wi-fi network or create its own network that can be connected to. When set to “Create QuickDraw Wi-fi” the QuickDraw controller will create a Wi-fi network that can be connected to by other devices. When set to “Connect to External Wi-fi” the QuickDraw controller will attempt to connect to an existing Wi-fi network. See “QuickDraw Wi-fi” and “Remote Wi-fi” for network login settings.

QuickDraw Wi-fi:

When “Wi-fi Connection” is set to “Create QuickDraw Wi-fi” the SSID will be the name of the network the QuickDraw controller creates and the Password will be the Network Security Key for that Wi-Fi network.

Remote Wi-fi:

When “Wi-fi Connection” is set to “Connect to External Wi-fi” the SSID will be the name of the network the QuickDraw controller will try to connect to and Password is the Network Security Key for that network. To select the network to which you want to connect, click “Scan For Wi-fi”. This will create a list of all available networks at which point you can choose the correct one by clicking it.

Scan for Wi-fi:

Clicking “Scan for Wi-fi” will display all available Wi-fi networks and associated signal strength. Clicking on an available network will set that network to the network the QuickDraw attempts to connect to when “Wi-fi Connection” is set to “Connect to External Wi-fi”.

Reset IP Address:

When “Wi-fi Connection” is set to “Connect to External Wi-fi” the “Reset IP Settings” button will be visible. Clicking this will force the QuickDraw to reconnect to the network and find a new IP address. This is sometimes necessary when connecting to a new network.

OPTIONAL Remote Connectivity Package

An optional Remote Connectivity Package is available for the QuickDraw 3000. This includes a modem with antenna to allow the QuickDraw to communicate via the internet. This option requires the purchase of a renewable subscription plan.

With the Remote Connectivity Package a batch report email can be sent at the completion of each batch. Other cloud connectivity features are also in development for future release.

Batch Complete Email **ENABLED**

Batch Completed Report Email Addresses

Email 1:

Email 2:

Email 3:

Batched Data	2020-02-10 14:00,
QuickDraw Identifier	QD1234
Mix Name	Example Recipe
Batch ID	027-02/10/20
Client	MAW
Farm	Rawlins
Field	W80
State	CO
County	Rawlins
Batch Status	Completed
Wind/Temperature	SW 4.0 MPH, 66.0 degF
Total Area	10.0 Acres
Total Batched	99.8 GAL

This is part of the report that will be sent to the email address(es) listed.

The report will also include the Rate and Total Amount of each carrier and chemical in the batch (see page 51).



Field and Weather Settings

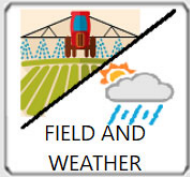

This information is optional, but it will become a part of the batch record and will be a part of the historical record.

FIELD AND WEATHER SETTINGS

Grower:	<input type="text"/>	Field:	<input type="text"/>
Farm:	<input type="text" value="Big Farm"/>	Recipe:	<input type="text" value="Corn Pre 2021"/>
Operator:	<input type="text"/>	Machine:	<input type="text"/>
Crop:	<input type="text"/>	Pest:	<input type="text"/>

Temperature: °F Wind Dir/Speed: N MPH Boom Height: Inches

 These buttons will show up if a USB is inserted that has the proper files for this. See instructions below or on the website.

If you want to import fields from John Deere Operations Center or from other software, press on this button and follow the instructions to export the data from Operations Center or other software to a USB Drive, and then import it to the QuickDraw.

Data Import Instructions

Visit support.surefireag.com for all documents.

Fields

System Settings 1

Grower/Farm/Field Tree



Grower/Farm/Field Tree: If ENABLED, the user will only see Farms associated with the current Grower, and Fields associated with the current Farm when selecting Farms and Fields. If DISABLED, the user will be able to see all the Farms and Fields while selecting.

Maintenance



If a valve is replaced or moved, it is necessary to reset the valve address, so the controller knows which valve it is communicating with.

DO NOT RESET A VALVE ADDRESS UNLESS A VALVE HAS BEEN REPLACED OR MOVED.

This screen also shows the Software and Display Rev that are on the QD controller.

Check these periodically with the versions found at support.SurePointag.com to keep your QuickDraw up to date. See further Software Update instructions on pages 79-81 of this manual.

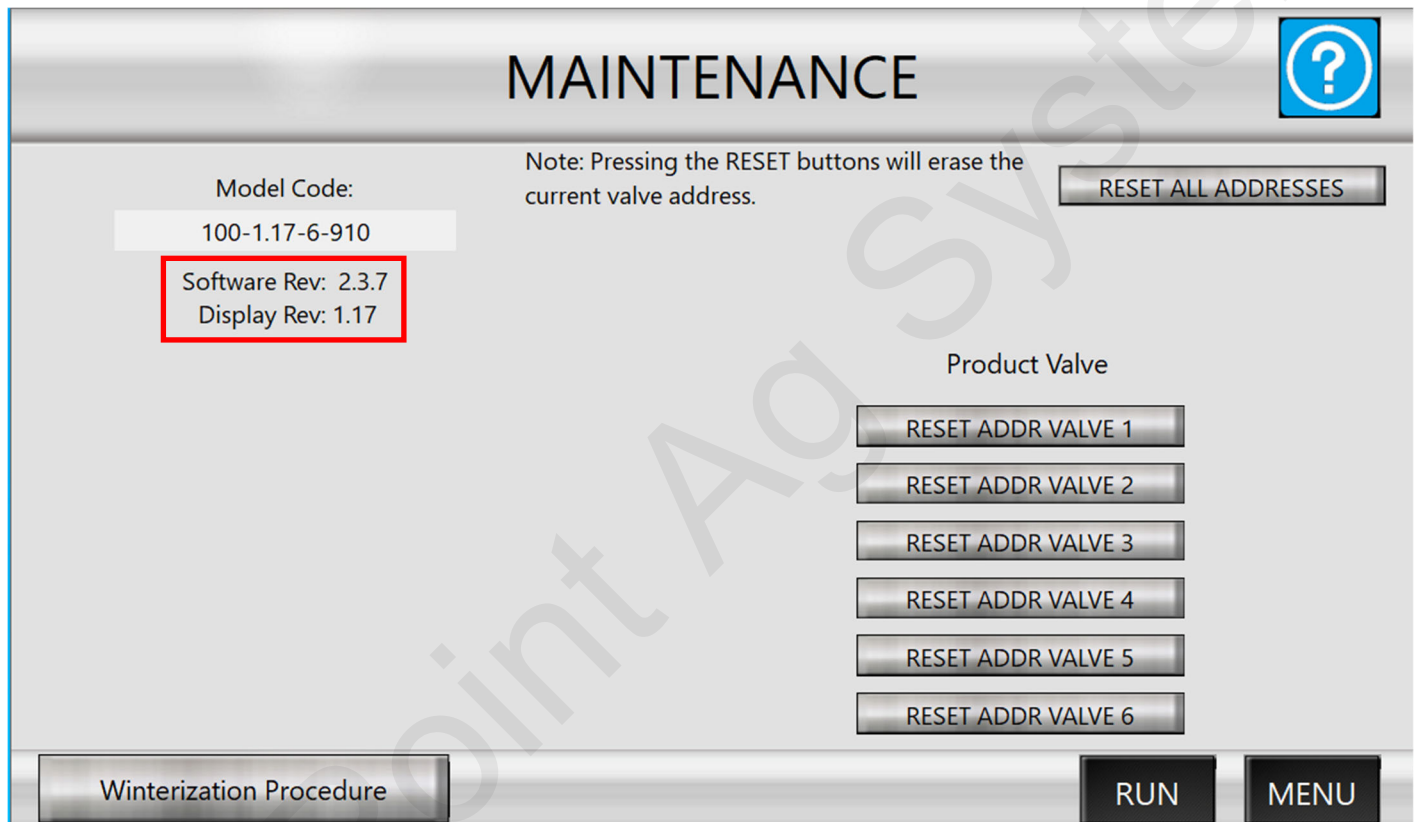

Press the **Winterization Procedure** button to see the instructions for winterization.

These instructions are on pages 77 and 78.

SurePoint Ag Systems



History



HISTORY will be transferred to the iPad whenever the iPad is connected via WI-FI to the QuickDraw controller.

<< <

BATCH HISTORY

>

32 / 33

Recipe: Corn Pre 2021	Batch ID: 042-121120	Total: 999.7 GAL
Grower: Wolters Farms	Date/Time: 12-11-2020 10:26	Acres: 100.0
Farm: Matt Wolters	Wind/Temp: 0.0MPH N 0.0°F	Rate: 10.0 GAL/Acre
Field: 29-2-33	Batch Time: 9.3 Min	Status: Completed
Operator: William Johnson	Machine: John Deere 4930	

Product	EPA ID	Rate	Total
Carrier1: Water		9.3 GAL/Acre	934.5 GAL
Product1: Atrav 4L (Atrazine)	89167-38-89391	1.00 Quarts/Acre	25.0 GAL
Product2:		0.00	0.0
Product3: Slam 54 Extra (glyphosate)	80967-5-93033	26.00 OZ/Acre	20.2 GAL
Product4: Moccasin	70506-323	4.00 OZ/Acre	3.0 GAL
Man. Prod1: AMS	3427-5678-89	17.00 lbs/100	170.0 lbs
Man. Prod2:		0.00	0.0
Man. Prod3:		0.00	0.0
Man. Prod4:		0.00	0.0
Man. Prod5:		0.00	0.0

List
DELETE
RUN
MENU

HISTORY RECORDS

Number of Results: 33 Sort By: Batch ID Sort Direction: Descending

Batch ID	Recipe	Grower	Farm	Field
026-120320	Example Recipe	Wolters Farms	Matt Wolters	29-2-33
025-120120	Example Recipe	Wolters Farms	Matt Wolters	29-2-33
024-112420	Corn Pre 2021	Wolters Farms	Matt Wolters	29-2-33
023-112420	Corn Pre 2021	Wolters Farms	Matt Wolters	29-2-33
022-112420	Corn Pre 2021	Wolters Farms	Matt Wolters	29-2-33
021-112420	Corn Pre 2021	Wolters Farms	Matt Wolters	29-2-33
020-112420	Corn Pre 2021	Wolters Farms	Matt Wolters	29-2-33
019-112420	Corn Pre 2021	Wolters Farms	Matt Wolters	29-2-33
018-111820	29-1-33 Airport Corn Fer...	Wolters Farms	Matt Wolters	29-2-33
017-111820	29-1-33 Airport Corn Fer...	Wolters Farms	Matt Wolters	29-2-33
016-111820	29-1-33 Airport Corn Fer...		Matt Wolters	
015-111820	29-1-33 Airport Corn Fer...		Matt Wolters	
014-111720	29-1-33 Airport Corn Fer...	Wolters Farms	Matt Wolters	29-2-33
013-111620	Corn Pre 2021	Wolters Farms	Matt Wolters	29-2-33
012-111320	Corn Pre 2021	Wolters Farms	Matt Wolters	29-2-33

DELETE ALL
View Details
BACK

History (from iPad App)

BATCH HISTORY

130 / 130

Recipe: Corn Pre 2021	Batch ID: 042-121120	Total: 999.7 GAL
Grower: Wolters Farms	Date/Time: 12-11-2020 10:26	Acres: 100.0
Farm: Matt Wolters	Wind/Temp: 0.0MPH N 0.0 F	Rate: 10.0 GAL/Acre
Field: 29-2-33	Batch Time: 9.3 Min	Status: Completed
Operator: William Johnson	Machine: John Deere 4930	QD ID: QD15

	Product	EPA ID	Rate	Total
Carrier1:	Water		9.3 GAL/Acre	934.5 GAL
Product1:	Atra-V 4L (Atrazine)	89167-38-89391	1.00 Quarts/Acre	25.0 GAL
Product2:				
Product3:	Slam 54 Extra (glyphosate)	80967-5-93033	26.00 OZ/Acre	20.2 GAL
Product4:	Moccasin	70506-323	4.00 OZ/Acre	3.0 GAL
Man. Prod1:	AMS	3427-5678-89	17.00 lbs/100	170.0 lbs
Man. Prod2:				
Man. Prod3:				
Man. Prod4:				
Man. Prod5:				

List

RUN

MENU



HISTORY RECORDS

Number of Results: 130

Sort Direction: Descending

Sort By: Batch ID ▼

Batch ID	Recipe	Grower	Farm	Field	QD ID
042-121120	Corn Pre 2021	Wolters Farms	Matt Wolters		29-2-33
041-121120	Corn Pre 2021	Wolters Farms	Matt Wolters		29-2-33
040-121020	Corn Pre 2021	Wolters Farms	Matt Wolters		29-2-33
039-121020	Corn Pre 2021	Wolters Farms	Matt Wolters		29-2-33
038-121020	Corn Pre 2021	Wolters Farms	Matt Wolters		29-2-33
037-121020	Corn Pre 2021	Wolters Farms	Matt Wolters		29-2-33
036-121020	Corn Pre 2021	Wolters Farms	Matt Wolters		29-2-33
035-120520	Corn Pre 2021	Wolters Farms	Matt Wolters		29-2-33
034-120420	Corn Pre 2021	Wolters Farms	Matt Wolters	29-2-33	QD15

On the iPad, the Historical Batch records can be filtered by Date, Recipe, Grower, Farm, Field, Product, or QuickDraw ID. See the next page.

Reports of the filtered batches may be sent as a group, with a report on each batch and a final report on the cumulative totals of all products used.

FILTER

EMAIL

View Details

DELETE ALL

Cancel

History (from iPad App)—Filter by Date

HISTORY RECORDS

Number of Results: 4 Sort By: Batch ID Sort Direction: **Descending**

Batch ID
034-11/07/1
033-11/07/1
032-11/07/1
030-11/07/1

Filter By:

Date

Recipe

Grower

Farm

Field

Product

Start Date

September	9	2017
October	10	2018
November	11	2019
December	12	2020
January	13	2021

End Date

September	9	2017
October	10	2018
November	11	2019
December	12	2020
January	13	2021

DONE

Field
S80
S80
W40
W40

Use the Filter feature to select only the records you want to see.

You can filter by more than one field (AND/OR)

FILTER

EMAIL

View Details

Cancel

Filter by Recipe, Grower, Farm, Field, Product, QD ID

HISTORY RECORDS

Number of Results: 61 Sort By: Batch ID Sort Direction: **Descending**

Batch ID
030-12/27/1
029-12/17/1
028-12/17/1
027-12/17/1
026-12/04/1
025-12/04/1
024-12/04/1
023-12/04/1
022-12/04/1
021-12/04/1
020-12/04/1
019-10/28/1
018-10/28/1

Filter By:

Date

Recipe

Grower

Farm

Field

Product

QD ID

Farm

BEGINS WITH

CONTAINS

EQUALS

Finished

Field

FILTER

EMAIL

View Details

DELETE LIST

Cancel





History.html
7 KB

This is the **SUMMARY** (HTML) file that is emailed from the iPad app. It can be a filtered batch list. The bottom panel in this SUMMARY is the total of the batches in the list.

Batch ID: 032-11/07/19	Recipe: Training 1
Grower: MW	Date/Time: 11-07-2019 10:59
Farm: H and E	Wind/Temp:: 5.0MPH SW 74.0 F
Field: W40	Status: Completed
Operator: MW	Total: 300.0
Machine:	Acres: 20.0

Product (EPA ID)	Rate	Total
-Water ()		283.1 GAL
Amazon (1111)	32.00 OZ/Acre	5.0 GAL
Bravo (2222)	1.00 Pints/Acre	2.5 GAL
Chaser (3333)	24.00 OZ/Acre	3.7 GAL
AMS ()	17.00 lbs/100	51.0 lbs
Manual 2 ()	4.00 OZ/Acre	80.0 OZ

Batch ID: 030-11/07/19	Recipe: Training 1
Grower: MW	Date/Time: 11-07-2019 10:46
Farm: H and E	Wind/Temp:: 4.0MPH SW 72.0 F
Field: W40	Status: Completed
Operator: MW	Total: 299.8
Machine:	Acres: 20.0

Product (EPA ID)	Rate	Total
-Water ()		282.8 GAL
Amazon (1111)	32.00 OZ/Acre	5.0 GAL
Bravo (2222)	1.00 Pints/Acre	2.6 GAL
Chaser (3333)	24.00 OZ/Acre	3.7 GAL
AMS ()	17.00 lbs/100	51.0 lbs
Manual 2 ()	4.00 OZ/Acre	80.0 OZ

Total

Product (EPA ID)	Total
Water ()	565.9 GAL
Amazon (1111)	10.0 GAL
Bravo (2222)	5.1 GAL
Chaser (3333)	7.4 GAL
AMS ()	102.0 lbs
Manual 2 ()	160.0 OZ



History—Emailed Batch .csv File from QD 3000

When the QuickDraw is set up for remote connectivity, if “Batch Complete Email” is Enabled on the Remote Settings Screen, the following report will be emailed after each batch to the email(s) entered.

Batched Data	2020-02-10 14:00,	
QuickDraw Identifier	QD1234	
Mix Name	Example Recipe	
Batch ID	027-02/10/20	
Client	MAW	
Farm	Rawlins	
Field	W80	
State	CO	
County	Rawlins	
Batch Status	Completed	
Wind/Temperature	SW 4.0 MPH, 66.0 deg F	
Total Area	10.0 Acres	
Total Batched	99.8 GAL	
	Total Carrier	92.9 GAL
Carrier Name	Water	
	Rate	3.3 GAL/Acres
	Total	35.8 GAL
Carrier Name	Fert 1	
	Rate	1.9 GAL/Acres
	Total	19.1 GAL
Carrier Name	Fert 2	
	Rate	1.9 GAL/Acres
	Total	19.0 GAL
Carrier Name	Fert 3	
	Rate	1.9 GAL/Acres
	Total	19.0 GAL
Product Name	Arrow	
	Rate	2.00 Pints/Acre
	Total	2.5 GAL
Product Name	Bravo	
	Rate	32.00 OZ/Acre
	Total	2.5 GAL
Product Name	Champion	
	Rate	24.00 OZ/Acre
	Total	1.9 GAL



Manual Controls



RUN **Manual Controls**

Use this screen to manually open and close a valve. Press on a valve to bring up the ON/OFF switch. **ACTUAL POSITION** is the position the valve is reporting to the controller.

SCAN ME

Manual Controls

Carrier Flow

1178.9 GAL
43.7 GPM

RESET

Mass Meter Flow

0.0 GAL
0.0 GPM

RESET

Pressure: 16.0 PSI

PRODUCT HOSE RINSE DISABLED

MASS METER DATA

Valve 1

Valve 2

Valve 3

Valve 4

Valve 5

Valve 6

SET POSITION	COMMAND POSITION	ACTUAL POSITION
0	0	0
0	0	0
0	0	0
0	0	0
0	0	0
0	0	0

2 Inch

3 Inch Valve

Rinse

Start Pump

Start Boost

Kill Pump

Start Purge

RUN

Carrier Flow

1262.9 GAL
39.4 GPM

RESET

Mass Meter Flow

0.0 GAL
0.0 GPM

RESET

Pressure: 15.9 PSI

PRODUCT HOSE RINSE DISABLED

MASS METER DATA

Valve 1

Valve 2

Valve 3

Valve 4

Valve 5

Valve 6

SET POSITION	COMMAND POSITION	ACTUAL POSITION
0	0	0
0	0	0
0	0	0
0	0	0
0	0	0
0	0	0

Moccasin Valve 4

⏻
⏻

✖

2 Inch

3 Inch Valve

Rinse

Start Pump

Start Boost

Kill Pump

Start Purge

RUN

Mass Meter Data

RUN **Manual Controls** **MASS METER DATA**

MASS METER DATA

Tube Frequency	256.79 Hz	Mass Flow	0.00 lbs/min
Left Pickoff	0.79 mV	Mass Total	235.6 lbs
Right Pickoff	0.79 mV	Mass Inventory	235.6 lbs
Drive Gain	2.54 %	RESET	
Product Density	8.33 lbs/gal	Flow Rate	0.00 GPM
Temperature	75.40 °F	Volume Total	28.2 GAL
Pressure	40.20 PSI	Volume Inventory	28.2 GAL

RUN **BACK**

This information will not normally be used. SurePoint Support may use it to evaluate the operation of the mass meter for troubleshooting purposes.

Carrier Flowmeter (Arag Orion X)

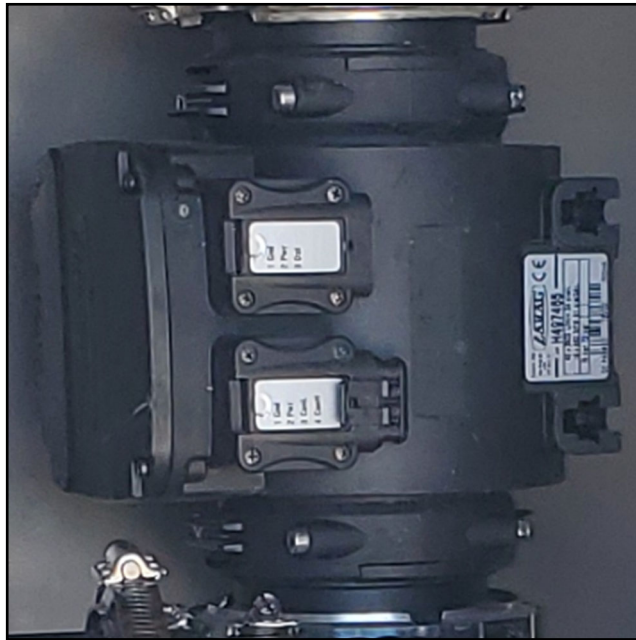

The standard carrier flowmeter is a 3" Arag Electro-magnetic flowmeter. The flowmeter calibration can be adjusted as needed to increase the accuracy of the carrier measurement.

The ORION X flowmeter is able to detect only the passage of conductive liquids with a conductivity equal to or greater than 300 $\mu\text{S}/\text{cm}$.

The chart below explains the meaning of the various light patterns that may be shown on the meter.

PN: 204-01-46299A91 3" Arag E-Mag Flowmeter (16-660 GPM)

	OFF	The flowmeter is not powered.
	GREEN BLINKING	The flowmeter is waiting to acquire an address on the CAN line to which it is connected.
	GREEN STEADY ON	Presence of STILL liquid inside the flowmeter.
	BLUE STEADY ON	The flowmeter is reading the passage of the liquid inside.
	VIOLET STEADY ON	No liquid has been detected inside the flowmeter.
	WHITE STEADY ON	Cleaning of the reading electrodes in progress.
	RED BLINKING	RED: Error. The error codes are indicated through blinks, which are described in the table below.
	RED STEADY ON	SEVERE ERROR: Contact a service center.

Red Blinking Lights	
2	Hardware Error—Contact ARAG authorized Service Center.
3	Corrupted Calibration Data—Contact ARAG authorized Service Center.
4	Power supply voltage too high or too low—Check the power supply voltage and restore the correct value.
5	Unstable reading—Check that the flow is normal and make sure to have complied with the hydraulic connection instructions (position, pipe dimensions, straight sections before and after the flowmeter, etc.

6	Too high temperature has been detected—Check ambient temperature and, if outside the specified limits, turn off the device and, before turning it on again, wait for the temperature to fall within the specified ones.
7	Setting data are corrupted and the default ones have been restored—Contact an ARAG authorized Service Center to check data integrity and to restore correct operation. Check that all settings are as required, validate data by accessing the “New notifications” menu and press OK (the operation can be performed only by skilled technical staff).

SurePoint Ag Systems



iPad App (QuickDraw 3000 App)

The iPad app is not necessary to operate the QuickDraw 3000 in the field, but it does provide many convenience features, and *the QuickDraw 3000 is intended to be used with an iPad. The QD 3000 app is NOT the same as the original QD app. The new QD 3000 iPad must be downloaded and used.*

With the iPad app, new recipes can be created, existing recipes can be edited, and products can be entered and set up. Grower, farm, field, operator, and other information can be entered and set up on the iPad without being near the QuickDraw. Setup can be done at home or in the office on the iPad and then transferred to the QuickDraw when connected with the Wi-fi connection.

Historical records of batches and all other files from the QuickDraw controller will be transferred to the iPad when they are connected.

The iPad app can be used to START a batch and to report the progress of Manually Added Products during a batch. The user can monitor the progress of the batch from the iPad and does not have to stay by the controller.

The QD3000 iPad App, for the most part, has the same screens and navigation features as the QuickDraw controller. The iPad can be used in the OFFLINE mode (at home or in the office) to train a new user in navigating and setting up the system.

The iPad Menu screen has the all the same buttons as the QuickDraw controller, plus an additional Data Management button. These will be shown in the coming pages.

Using an iPad on more than one QuickDraw

A single iPad can be used to control/update multiple QuickDraws. Information/recipes that are added to the iPad while OFFLINE may be directed in whole or in part to individual controllers or to all controllers (See DATA MANAGEMENT > SEND > SEND & DELETE > DATA).

The iPad will store historical data from every controller it has ever connected to. When the iPad is OFFLINE, all historic data from every controller will be displayed. This data can be filtered as usual (explained later) and also by QuickDraw ID.

When the iPad is connected to a controller, it will only show data that is on that controller. Historical records from other controllers will not be visible. Also, any items that were created offline and that have not been sent to the controller will not be visible or selectable. (See Data Management later)

Get Started

On the iPad, go to the App Store and download the SurePoint QuickDraw 3000 app.

Follow the instructions on the following pages for:

1. Getting the iPad connected to the QuickDraw Wi-fi network and then,
2. Getting the iPad App and the QuickDraw communicating with each other.



iPad App Connection Instructions

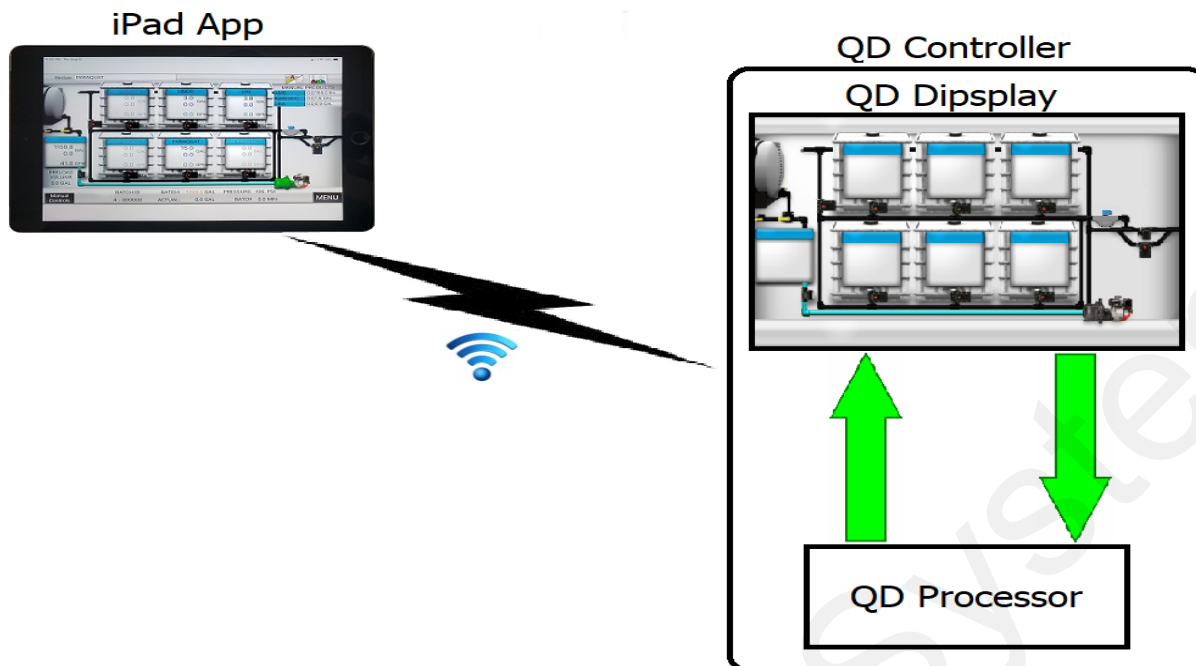

As the above image attempts to illustrate, the iPad app communicates with the QuickDraw Controller via a Wi-Fi connection. The following instructions detail how to set up this connection.

- Go to the Wi-fi Setup screen on the QD3000 controller via MENU->SETTINGS->Remote Settings->WI-FI. This will display the following screen which details the Wi-Fi settings for the QD Controller:

The screenshot shows the 'Wifi Settings' screen on the QD Controller. At the top left is a question mark icon, and at the top right is a 'Scan for Wifi' button. Below the title bar, there are two sections: 'Wifi Connection' and 'IP Settings'. The 'Wifi Connection' section has a dropdown menu set to 'Create QuickDraw Wifi' and a 'SAVE' button. The 'IP Settings' section displays: IP Address: 192.168.1.140, Net Mask: 255.255.0.0, Gateway: 192.168.1.99, and DNS: 192.168.1.11. Below these are two sections for network configuration: 'QuickDraw Wifi' with SSID: QuickDraw and WiFi Password: SureFire; and 'Remote Wifi' with SSID: SureFire Network and an empty WiFi Password field. At the bottom, a status bar shows 'QuickDraw Wifi Active...Network Name: QuickDraw' and three buttons: 'Remote Settings', 'RUN', and 'MENU'.

- The iPad needs to connect to the Wi-Fi network created by the QD Controller. To do this, click the



Settings button on your iPad to open the Settings. Select **Wi-Fi**:

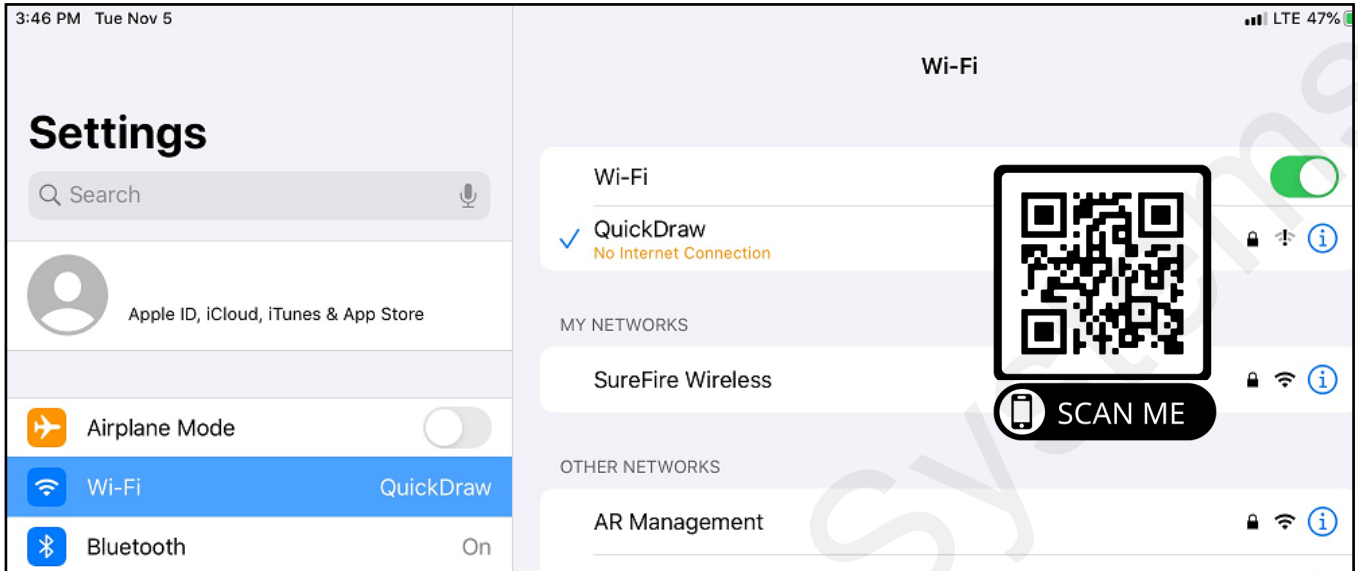

- Select the Wi-Fi network that matched the SSID found on the Wi-fi Setup screen of the QD Controller. In this case, “QuickDraw”.
- You will likely be prompted for a password to connect. Use the Passcode found below the SSID used in the previous step. In this case, “SurePoint”.
- You should now be connected to the QD Controller’s Wi-Fi network. The iPad will likely indicate that it has “No Internet Connection” as it does in the image above. This is normal and not a problem.
- Exit out of Settings on your iPad and open the QD3000 iPad app.
- On your iPad app, go to the Remote Settings screen via MENU->SETTINGS->Remote Settings.

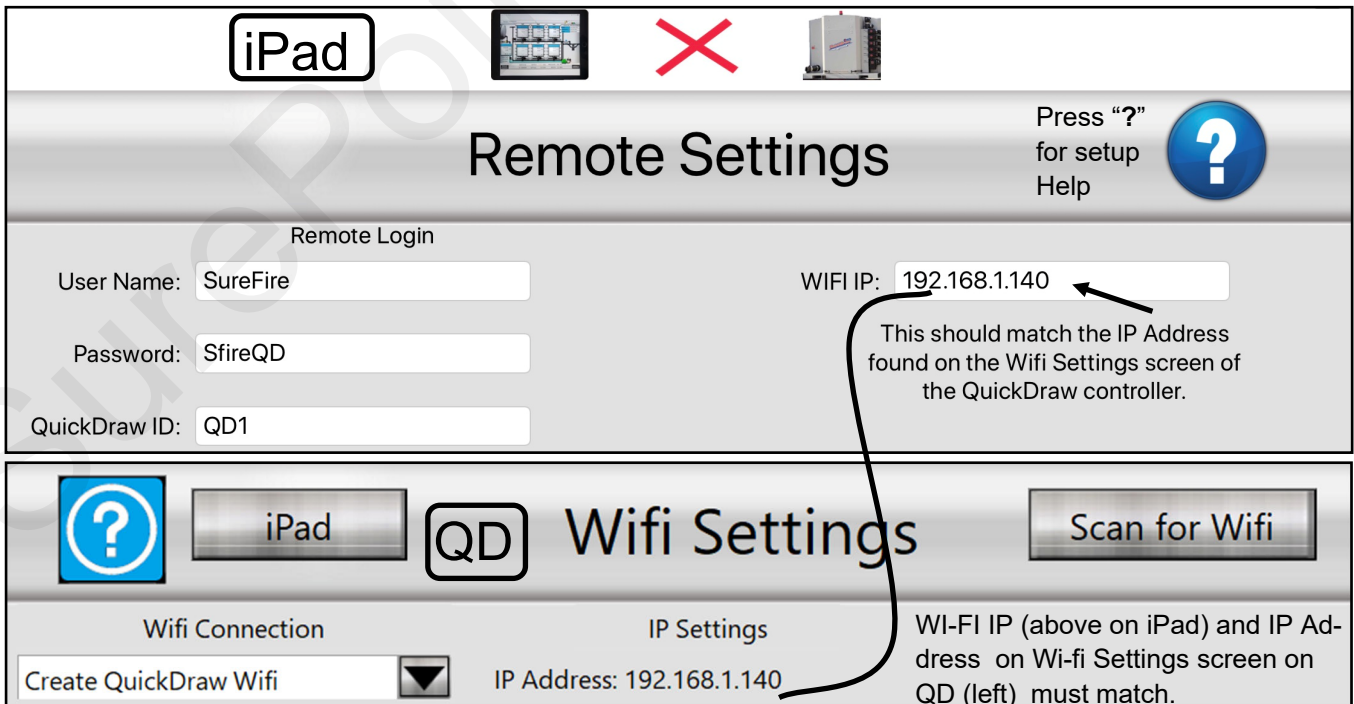

Remote Settings

Remote Login		IP Address: 192.168.1.135	COMM IP
User Name:	<input type="text" value="SureFire"/>	Net Mask: 255.255.0.0	192.168.1.135
Remote Password:	<input type="text" value="SfireQD"/>	Gateway: 192.168.1.99	
QuickDraw ID:	<input type="text" value="QD1"/>	DNS: 192.168.1.11	

- On the QD Controller, go back to the Remote Settings screen.
- The above image shows the default values for User Name, Password, and QuickDraw ID. **At least one of these needs to be changed from default before attempting to connect.** It usually makes the most sense to change the QuickDraw ID as this is used to identify the controller in historical records.
- The User Name, Password, and QuickDraw ID on the QD3000 iPad app must be set to match those found on the Remote Settings screen on the QD Controller.
- On the iPad app, click the Connection Status icon (press the red X) at the top of the screen to connect to the QD Controller.

- Successful connection will be indicated by the two green lines shown in the picture shown below:
- (Red lines indicate the connection has NOT been made.)



Green Lines = Connected

(To go OFFLINE, press on the Green Bars-will turn to Red X)



Red Lines = Connection FAILED

(Login Credentials are incorrect)



Red X = iPad is OFFLINE

(Press on Red X when you want to connect)

iPad App Menu and Data Management Screen



While working OFFLINE (indicated by the Red X), on the DATA MANAGEMENT SCREEN the user can ADD or EDIT entire recipes or the carrier(s) and products that will be used. Grower, Farm, Field, Operator, Crop, Machine, and Pest can also be added or edited.

When the iPad is later connected to the QuickDraw controller, these items can be transferred, in total or in part, to the QuickDraw controller. See the next page for the screens that will be available when the iPad is connected and there is new data on the iPad ready to be transferred to the QuickDraw.

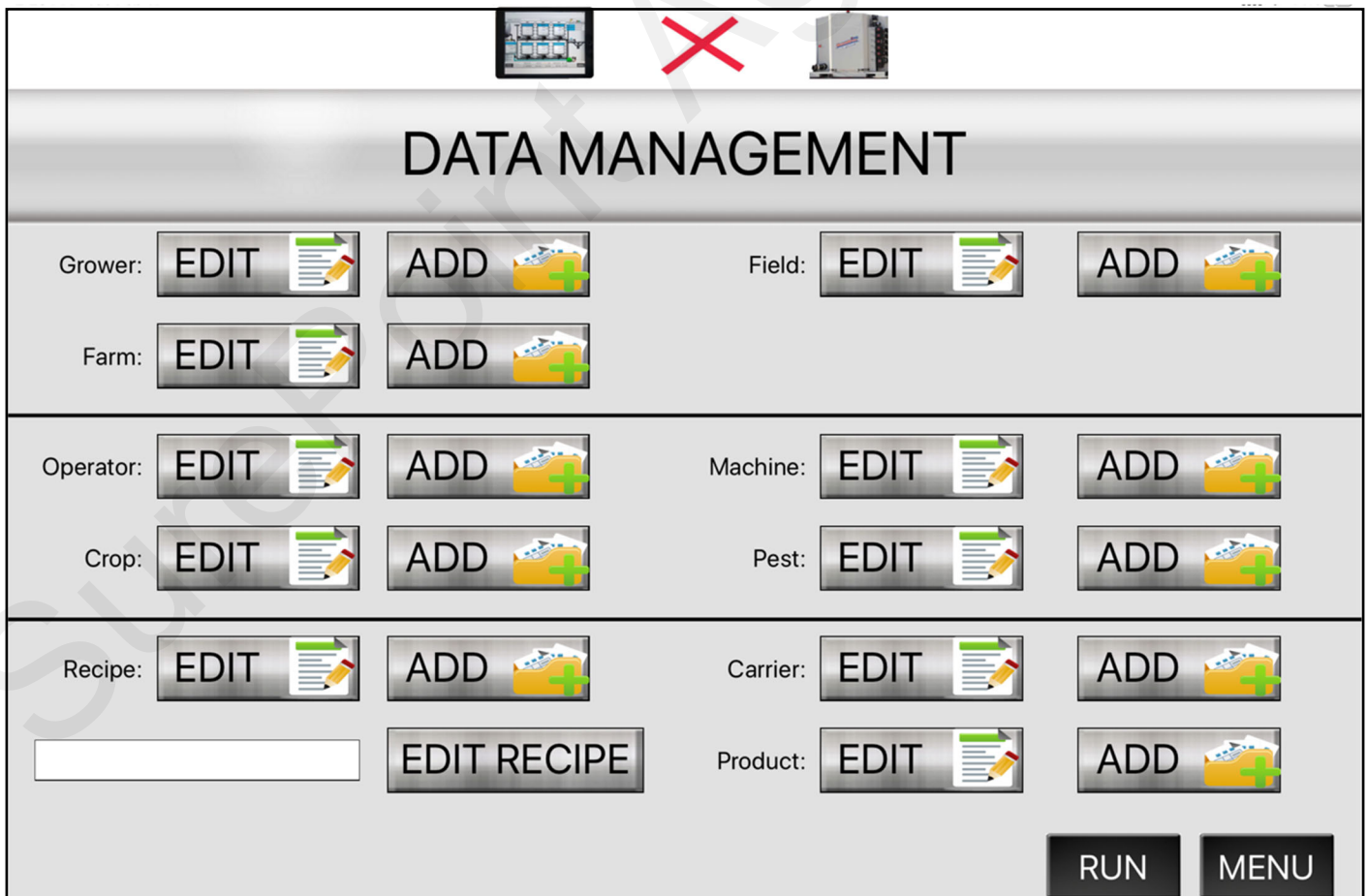

When information has been entered on the iPad App while the iPad is not connected to the QuickDraw controller, there will be a message at the bottom of the Data Management screen when the iPad is connected.



DATA MANAGEMENT

Grower: EDIT ADD	Field: EDIT ADD
Farm: EDIT ADD	
Operator: EDIT ADD	Machine: EDIT ADD
Crop: EDIT ADD	Pest: EDIT ADD
Recipe: EDIT ADD	Carrier: EDIT ADD
<input style="width: 100px; height: 20px;" type="text"/> EDIT RECIPE	Product: EDIT ADD

SEND SEND & DELETE DATA RUN MENU

Data exists that may not be on the QuickDraw. Click "SEND" or "SEND/DELETE" to send all the data. Click "DATA" to handle individual files.

Press **SEND** to send all the new data to the QD, and still leave the data on the iPad.
 Press **SEND & DELETE** to send all the data to the QD, and also to delete that data from the iPad.
 Press **DATA** to go to the next screen, where you can transfer individual parts of the new data.

DATA MANAGEMENT

Grower/Farm/Field:

SEND
SEND & DELETE
DELETE

Press **SEND** to send all the new data to the QD, and still leave the data on the iPad.
 Press **SEND & DELETE** to send all the data to the QD, and also to delete that data from the iPad.
 Press **DELETE** to delete any remaining new data in this category.

Recipe/Product/Carrier:

SEND
SEND & DELETE
DELETE

iPad Settings 1 and Settings 2

SETTINGS 1

Hide History Full Alarm <input type="checkbox"/>	Default lbs/Gal 10.0	Manual Product Valve Select 2 Inch Venturi-default
Grower/Farm/Field Tree <input checked="" type="checkbox"/>	Units English	Kill Pump During Pause <input type="checkbox"/>
Shuttle Inventory Alarms <input checked="" type="checkbox"/>	Pump Start Mode Momentary Start-Default	<p>The Settings pages on the iPad are similar to the pages on the QD. See the documentation for those pages in this manual.</p>
Carrier Inventory Alarms <input checked="" type="checkbox"/>	Pump Start Time 0.0 Sec	
Battery: 0.00 Volts		
Date Format Month/Day/Year		>

0 : 00 : 00 AM 0 / 0 / 0000
Remote Settings
RUN
MENU

SETTINGS 2

Product Valve	Close Time	Boost Pump	iPad Auto-Lock <input checked="" type="checkbox"/>
Valve 1 <input type="checkbox"/>	0.00 Sec	DISABLED	<p>If iPad Auto-Lock is ENABLED, the iPad may shut off during a batch if the iPad Auto-Lock times out.</p> <p>If iPad Auto-Lock is DISABLED, the iPad will stay on while the QuickDraw 3000 app is open. May affect battery.</p>
Valve 2 <input type="checkbox"/>	0.00 Sec	Purge Time	
Valve 3 <input type="checkbox"/>	0.00 Sec	0.0 Sec	
Valve 4 <input type="checkbox"/>	0.00 Sec		

MAINTENANCE

Model Code:
100-1.17-6-910

Software Rev: 2.3.7

iPad App Rev: 1.2.8

MAINTENANCE:

Shows iPad App Version number.

Check App Store for updates.

External Plumbing Fittings

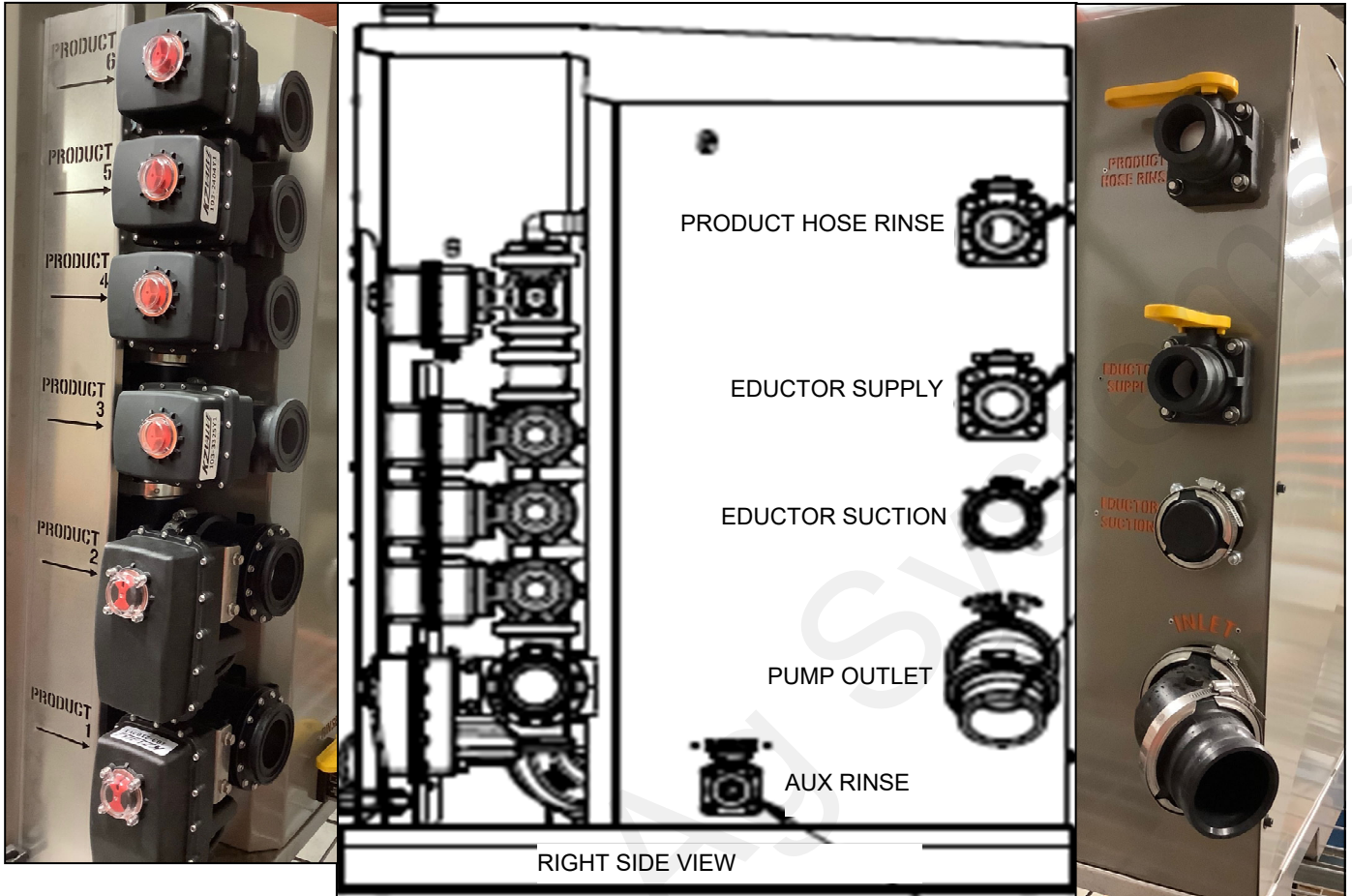

1 1/2" Product Valve (1 standard- with optional 3 valves on 6- or 9-product))	M220 flange
1" Product Valve (Valves 2—6, unless your system has 3 - 1 1/2" valves)	M200 flange
Product Hose Rinse	2" Male Camlock
Eductor Supply	2" Male Camlock
Eductor Suction	M200 flange
Pump Outlet (Inlet to QD)	3" Male Camlock
Aux Rinse	3/4" FPT
Outlet to Sprayer	3" Male Camlock

Carrier/Product Plumbing and Flow

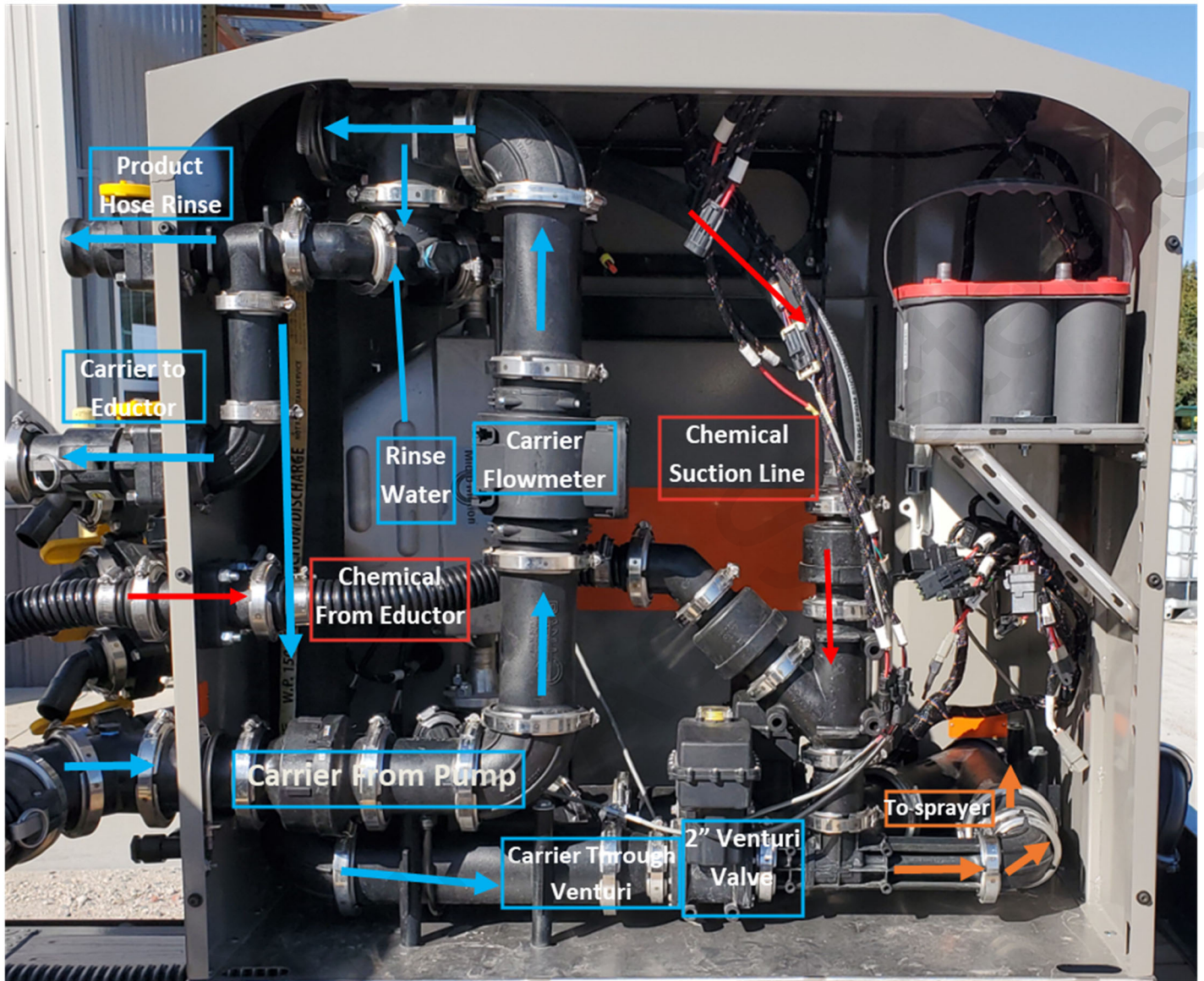

Rear View
(Cover Off)

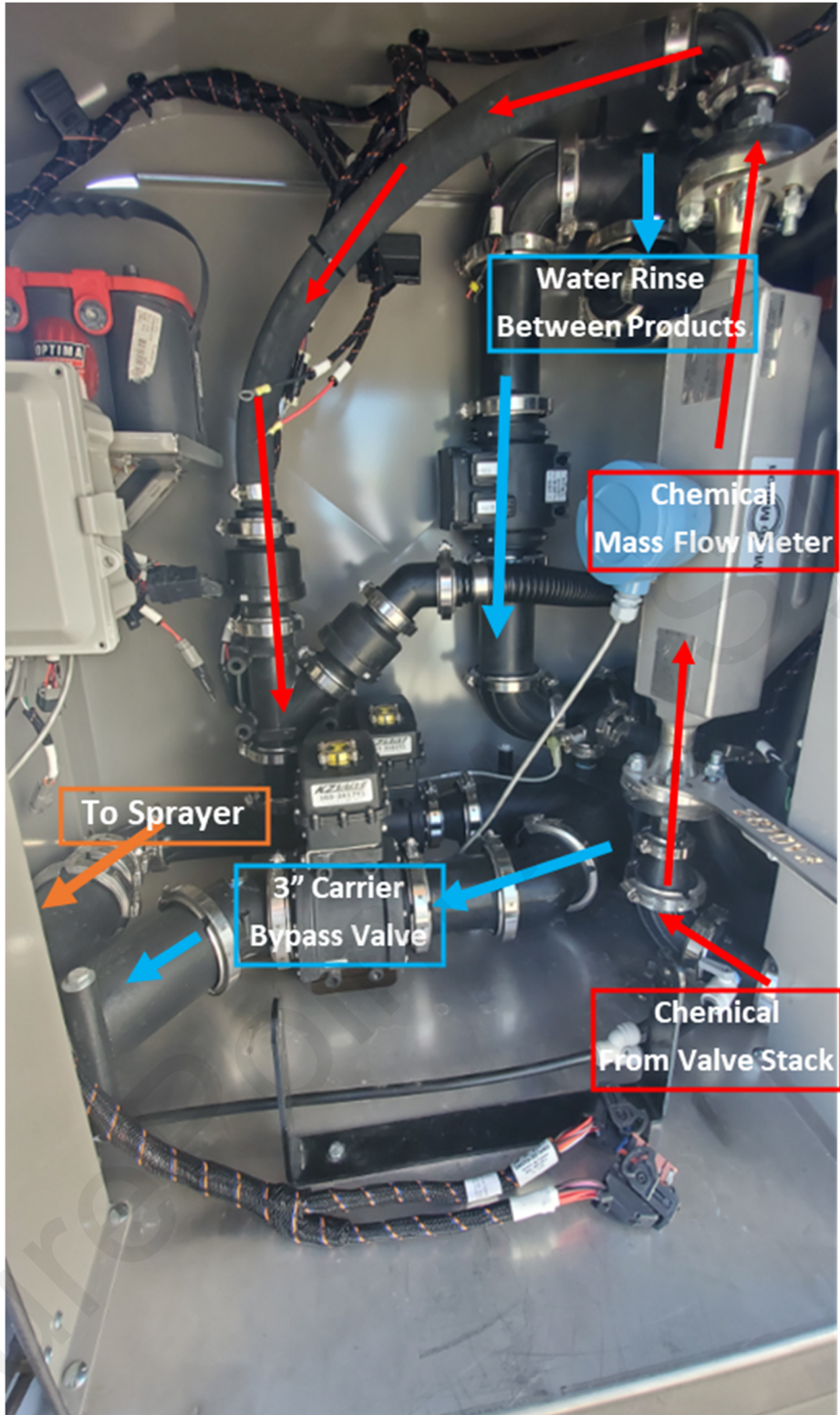

Front View

QuickDraw 3000 Main Plumbing Assembly

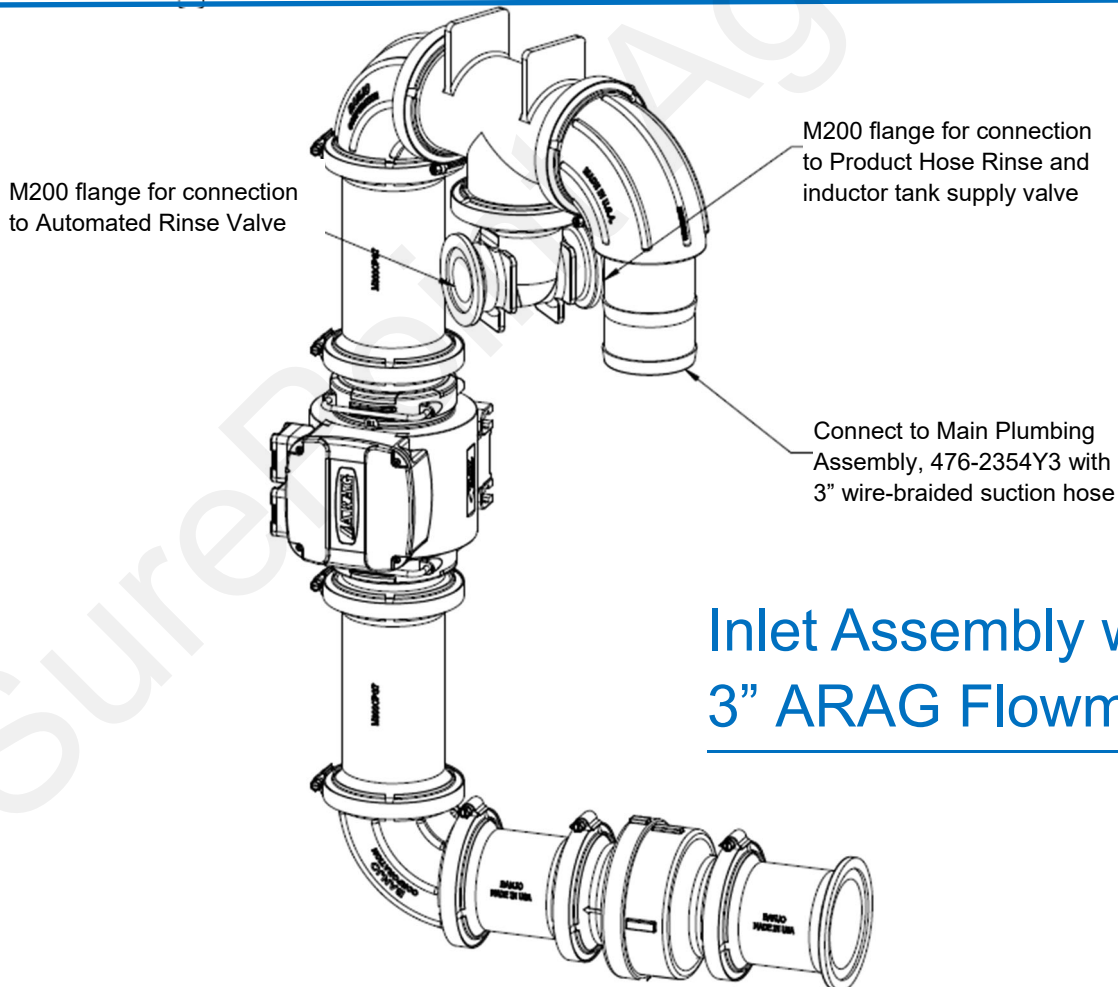
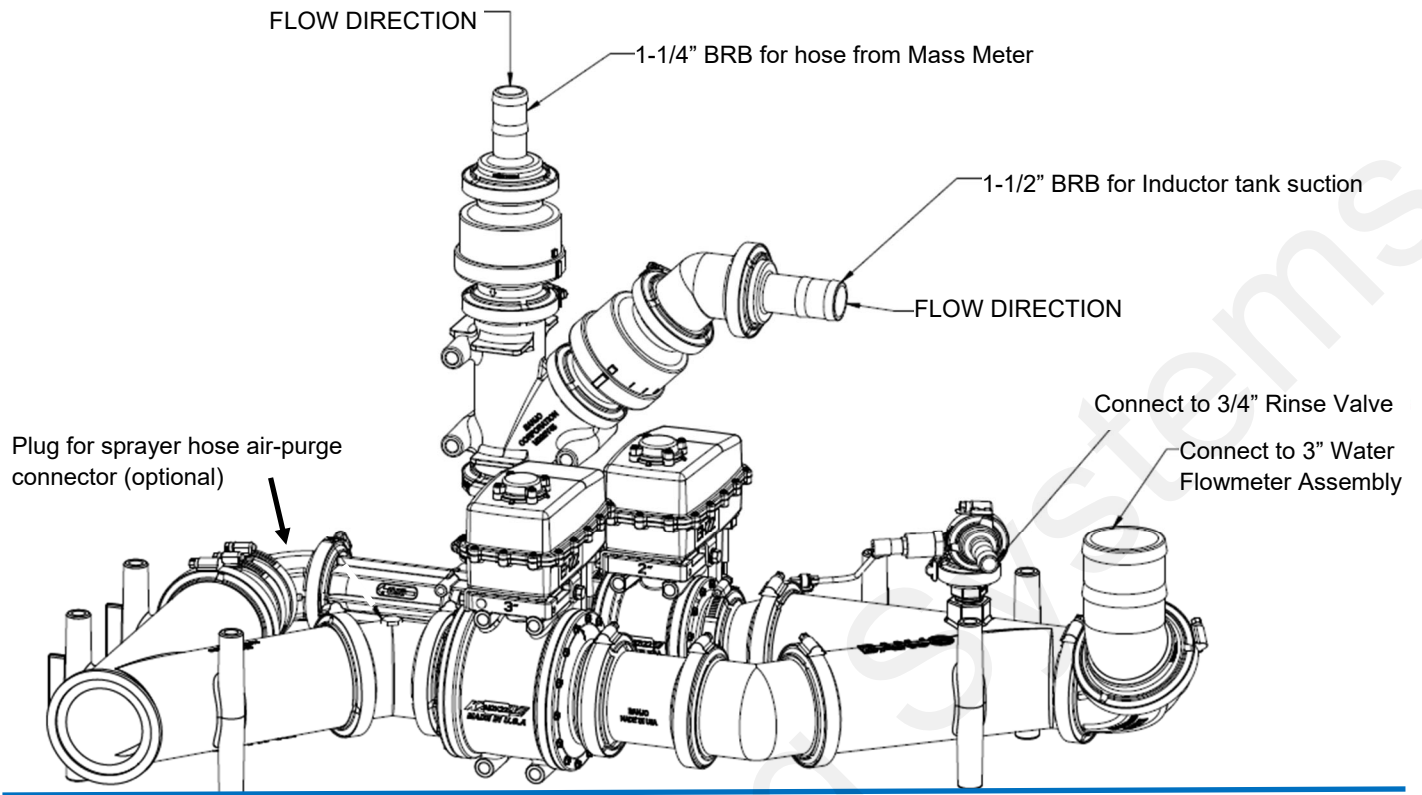

Inlet Assembly with 3" ARAG Flowmeter

QuickDraw 3000 Main Plumbing Assembly

Valve Replacement Breakout

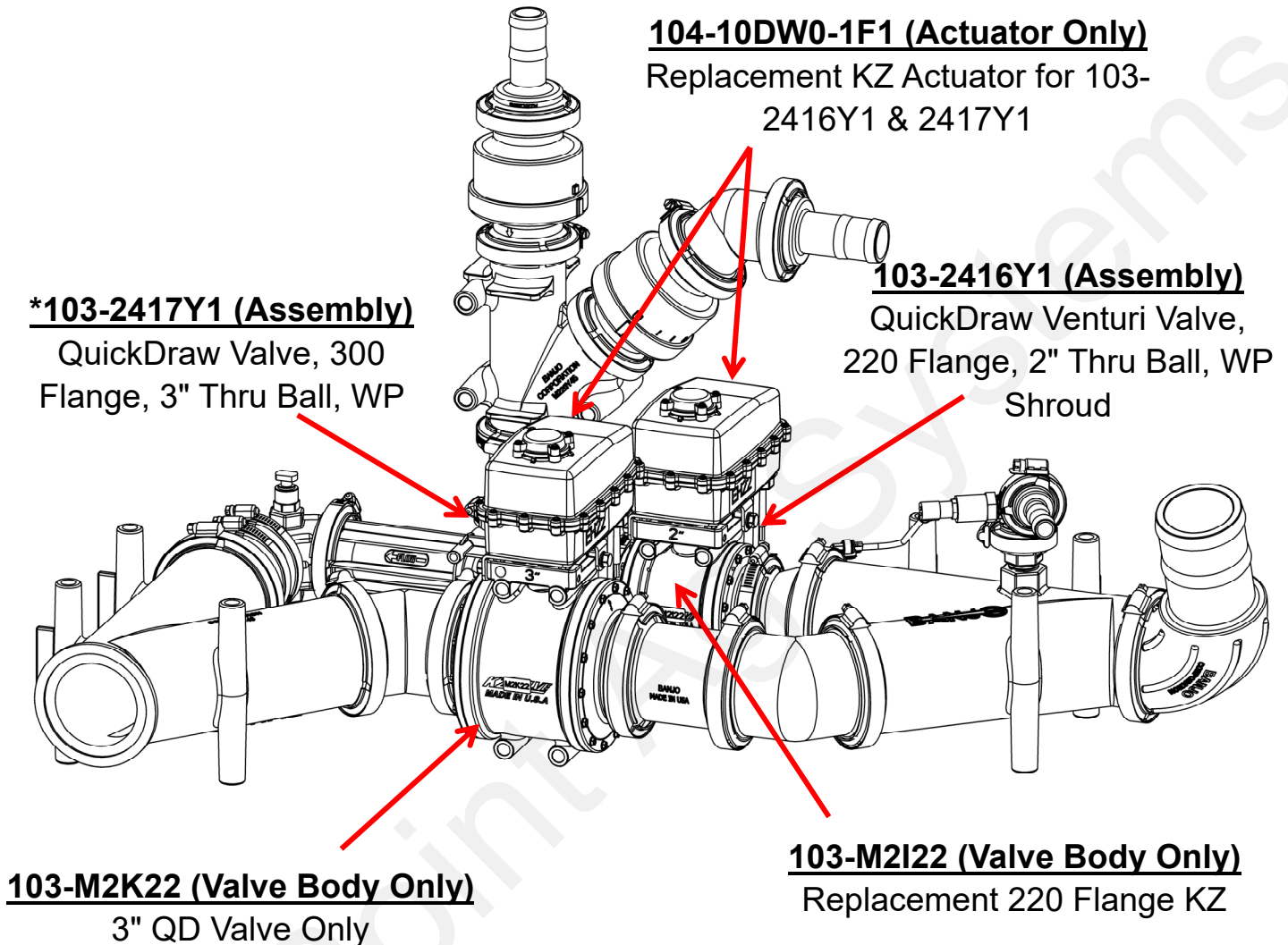

**3" CAN Valve used in QuickDraw Suction Applications*

103-3366Y (Valve Assembly)
3" KZ Valve Assembly - CAN Control

104-3636Y1 (Actuator Only)
QuickDraw Replacement CAN Actuator for 2", 3" & 4" (Butterfly) Valve

QuickDraw 3000 MY21-22

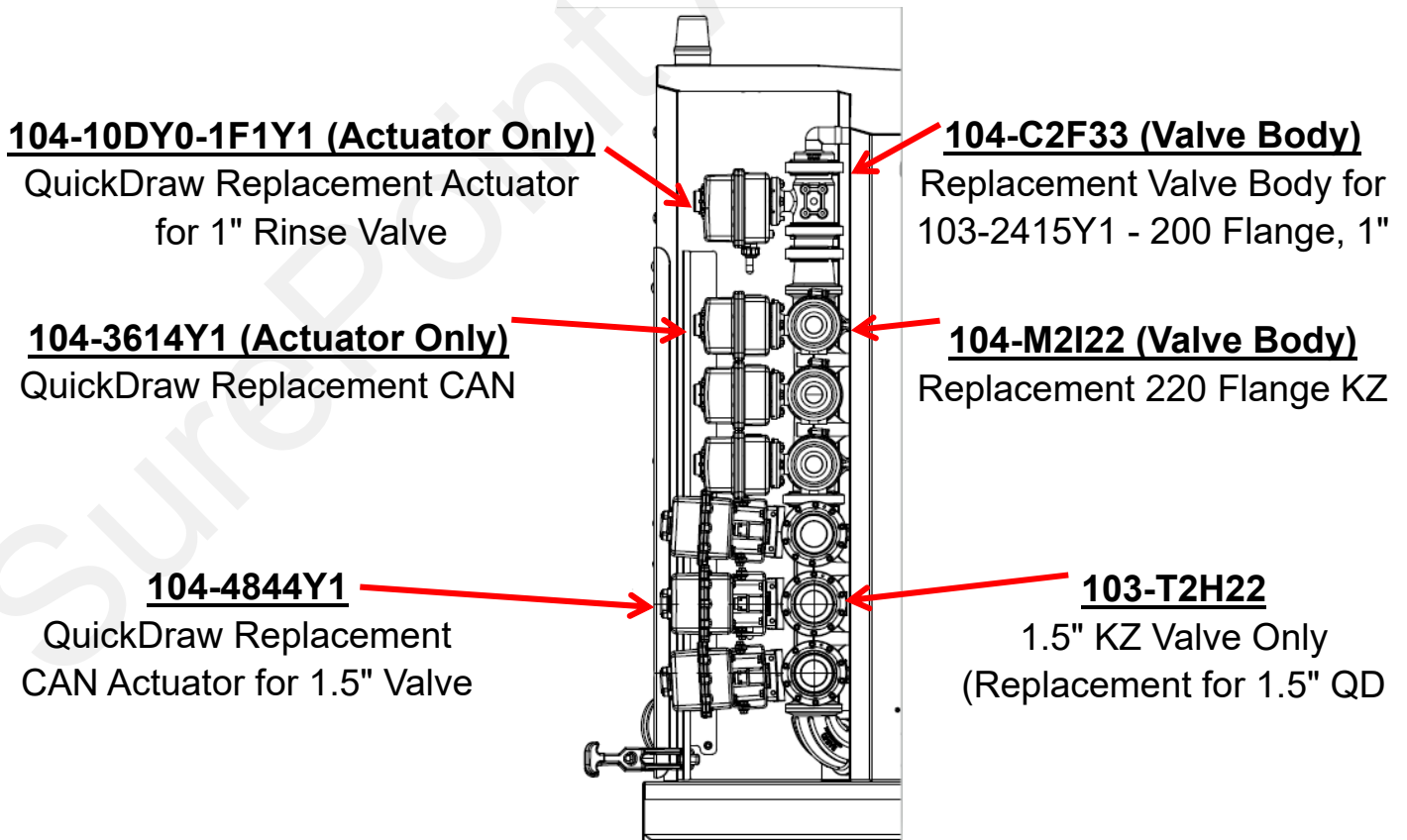
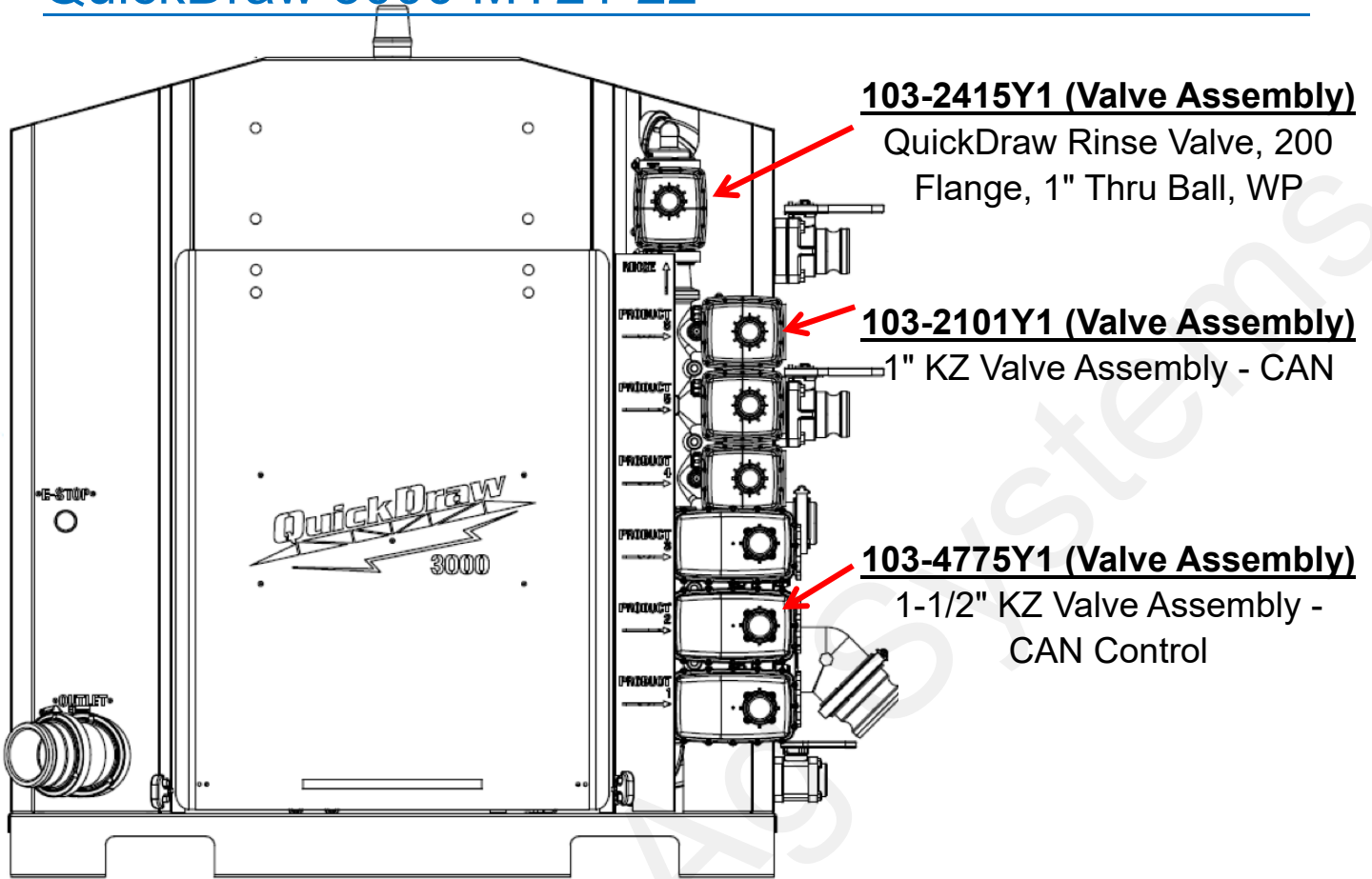

QuickDraw 3000 Dimension Drawing

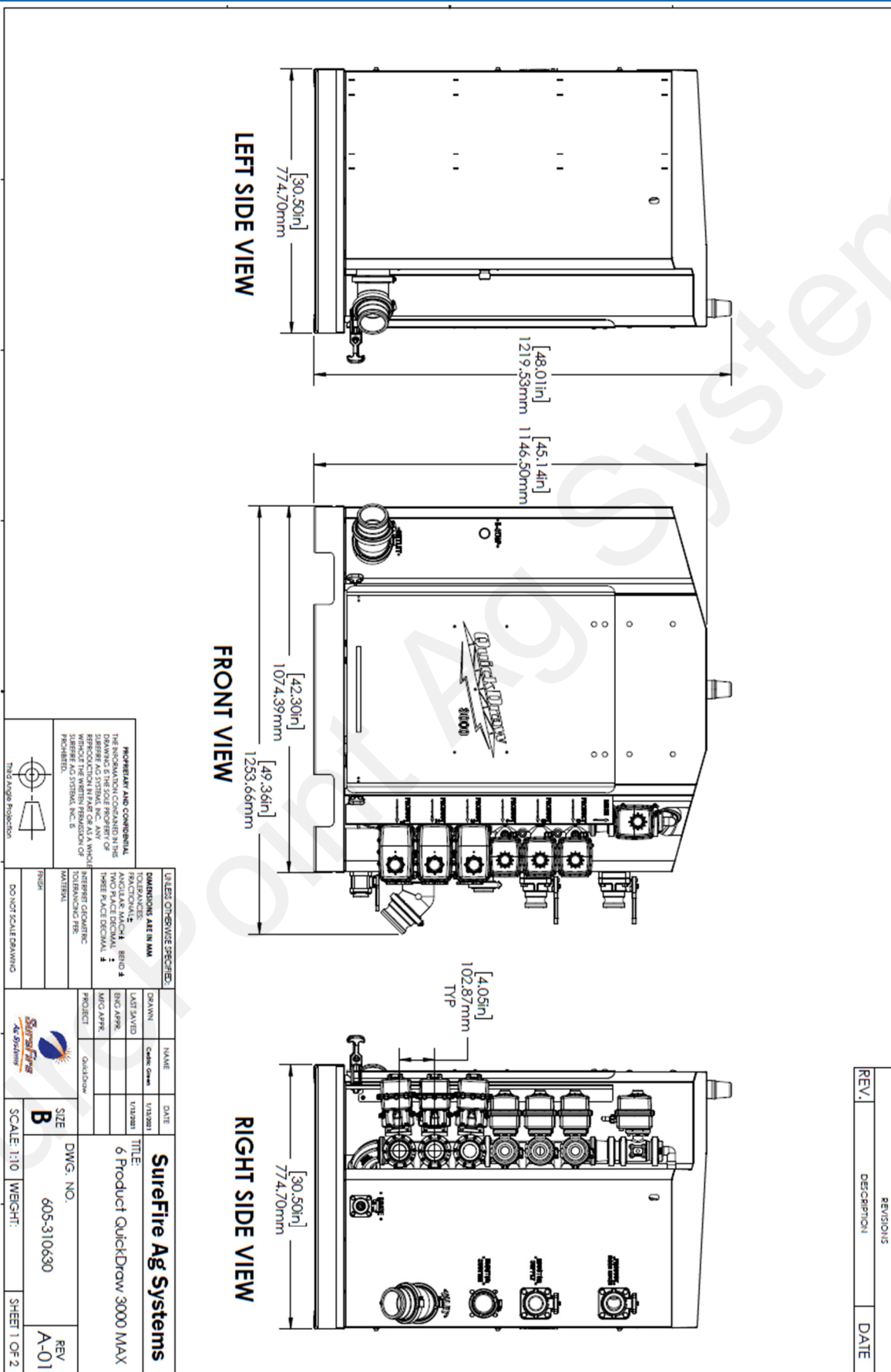

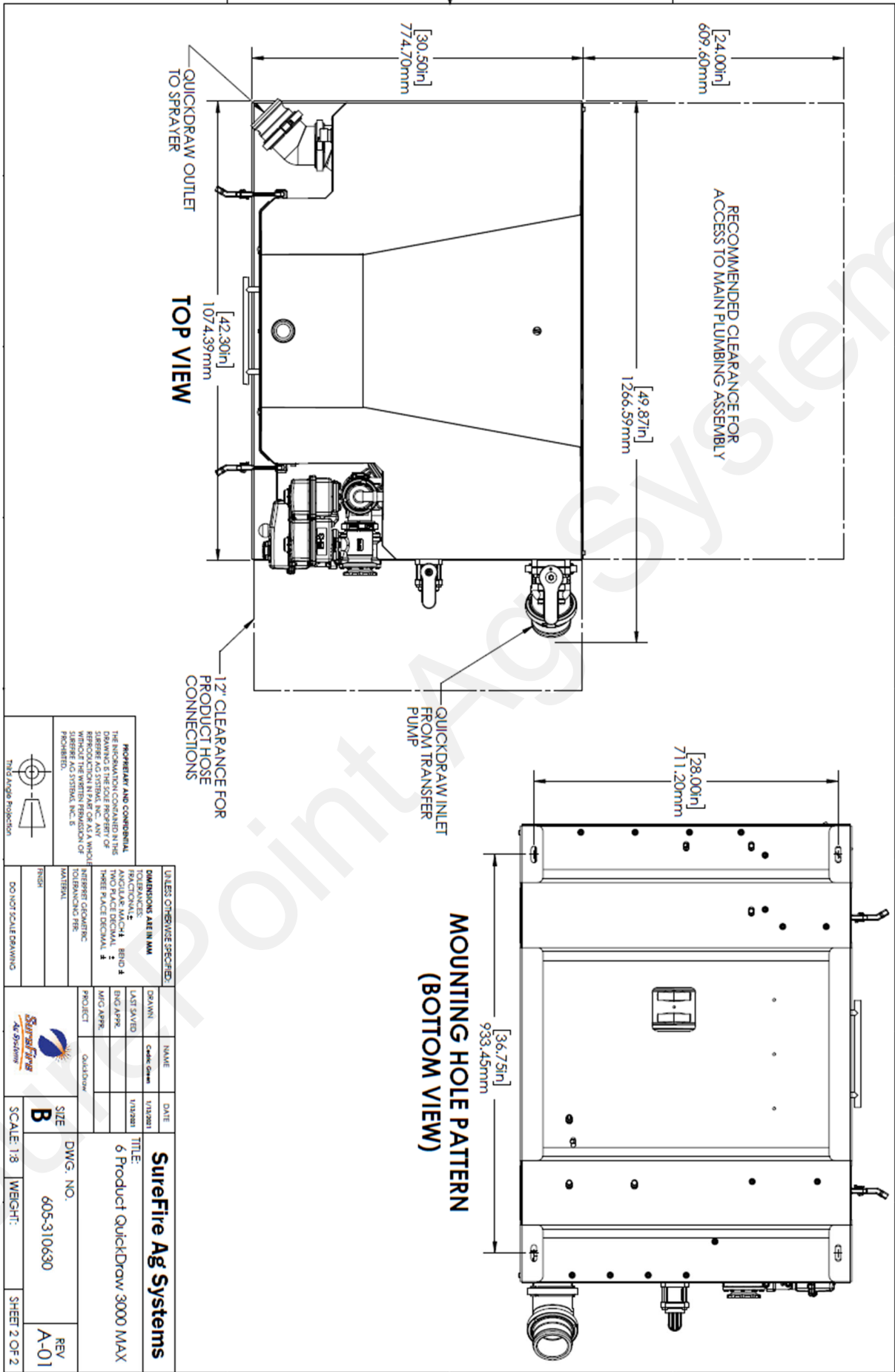

IMPORTANT AND CONFIDENTIAL
 THE INFORMATION CONTAINED IN THIS DRAWING IS THE SOLE PROPERTY OF SUREPOINT AG SYSTEMS, INC. ANY REPRODUCTION IN PART OR AS A WHOLE WITHOUT THE WRITTEN PERMISSION OF SUREPOINT AG SYSTEMS, INC. IS PROHIBITED.

UNLESS OTHERWISE SPECIFIED, DIMENSIONS ARE IN MM		TOLERANCES: FRACTIONAL ± .004, DECIMAL ± .001, ANGLES ± .05	
DIMENSIONS ARE IN MM		TOLERANCES: FRACTIONAL ± .004, DECIMAL ± .001, ANGLES ± .05	
DRAWING IS THE SOLE PROPERTY OF SUREPOINT AG SYSTEMS, INC. ANY REPRODUCTION IN PART OR AS A WHOLE WITHOUT THE WRITTEN PERMISSION OF SUREPOINT AG SYSTEMS, INC. IS PROHIBITED.		PROJECT: QuickDraw	
DO NOT SCALE DRAWING		SCALE: 1/8"	
SHEET 2 OF 2		REV A-01	

NAME	DATE	TITLE
LAST SALES	11/13/2021	6 Product QuickDraw 3000 MAX
ENG APPR		
MFG APPR		
PROJECT	QuickDraw	
DWG. NO.	605-310630	
SCALE: 1/8"	WEIGHT:	



QuickDraw Connection Kits

606-01-400325 QuickDraw Connection Kit for 1 1/2" Hose

606-01-400350 QuickDraw Connection Kit for 2" Hose

See 396-4887Y1 QuickDraw Hose Connection Instruction Sheet

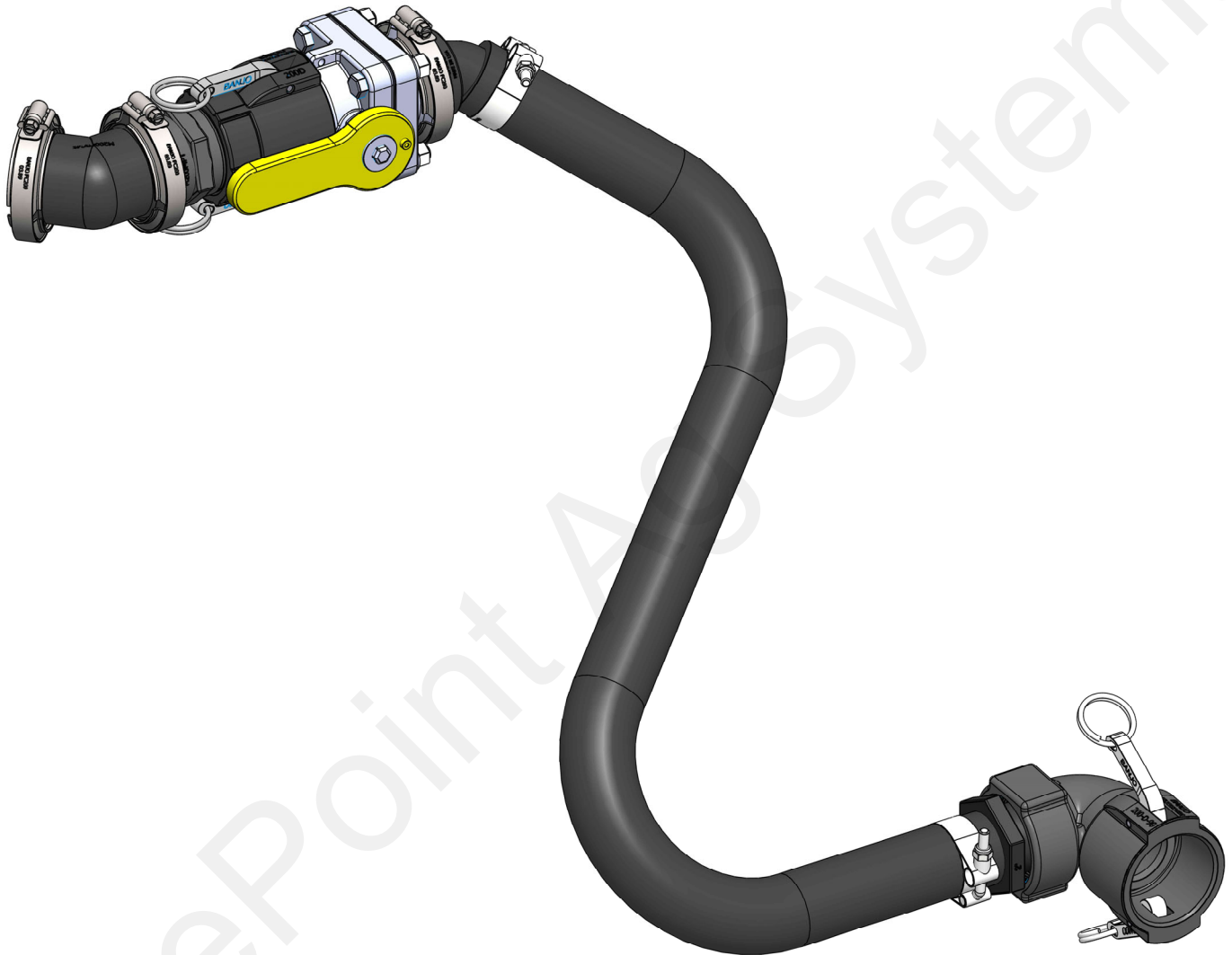

QuickDraw Educator Kits

606-02-300100	QuickDraw 20 Gallon Stainless Steel Swing-Down Tank With ChemBlade Kit
606-02-300200	QuickDraw 20 Gallon Stainless Steel Swing-Down Tank NO Blade Kit
606-02-300225	Stand Mount Educator 20 Gallon Tank Kit With ChemBlade - With 3" Bypass
606-02-300250	Stand Mount Educator 20 Gallon Tank Kit With ChemBlade - Without Bypass
606-02-300300	Plumbing Kit for Connecting Manual Educator to QuickDraw 3000 (Use for non-QuickDraw Educators)



QuickDraw Hose, Plumbing, and Valve Kits

606-04-100100	QuickDraw 3" Sprayer Fill Hose Kit
606-04-100200	QuickDraw Trailer 3" Plumbing Kit - 2 Carrier Tanks
606-04-100250	QuickDraw Trailer 3" Plumbing Kit - 2 Carrier Tanks w/ Electric Valves
606-04-100300	QuickDraw Trailer 3" Plumbing Kit - Single Carrier Tank
606-04-100350	QuickDraw Trailer 3" Plumbing Kit - Single Carrier Tank w/ Electric Valves
606-04-150200	2 Product Carrier Blending Kit - Valve Manifolds for Central Mounting
606-04-150300	3 Product Carrier Blending Kit - Valve Manifolds for Central Mounting
606-04-150400	4 Product Carrier Blending Kit - Valve Manifolds for Central Mounting
606-04-175200	2 Product Carrier Blending Kit - CAN Valves and Y Cables Only - (Need Plumbing and Ext. Cables)
606-04-175300	3 Product Carrier Blending Kit - CAN Valves and Y Cables Only - (Need Plumbing and Ext. Cables)
606-04-175400	4 Product Carrier Blending Kit - CAN Valves and Y Cables Only - (Need Plumbing and Ext. Cables)
606-04-200100	QuickDraw Trailer Harness Complete Kit (Pump Start/Stop & Power)
606-04-200150	QuickDraw Harness Kit for standard GX Honda Engine

Accessories

PUMPS

290-05-4788Y1	John Blue 3" Cast Iron Transfer Pump, Honda iGX390 11.7 HP AutoChoke
290-05-SP-3340-E10TB-1-FLG	3" John Blue Wet Seal Pump with 10 HP 1-Phase Electric Motor
290-05-SP-3345-PHL-FLG	John Blue 10 HP Hydraulic Motor Drive, 3" Cast Iron Wet Seal Transfer Pump
290-05-SP-3350-BS-FLG	John Blue, 3" Cast Iron Self-Priming Transfer Pump (Pump Only for Mounting to Honda Engine)
290-05-SP-3350-E15TB-FLG	John Blue, 15 HP 3 Phase Electric Motor, 3" Self Priming Centrifugal TEFC Powered Pump
290-05-SP-3350-G13HFLG	John Blue, 13 HP Honda, 3" Cast Iron Wet Seal Transfer Pump

208-05-2414Y1 Pump Stop Harness (Gas Engine or Electric Motor)
 208-05-2431Y1 Pump Start Harness (Electric Motors Driven Only)
 208-05-2430Y1 QuickDraw Electric Start Gas Engine 12 Volt Supply Harness
 208-05-3944Y1 QuickDraw Gas Engine Push Button Start
 606-03-300150 QuickDraw Air Purge Kit w/ Pressure Regulator and Valve (MY 2021)

606-03-300175 QuickDraw Air Purge Retrofit Kit for MY 2020 and Prior

606-03-500100 3" Cast Iron Pump, Honda iGX390 AutoChoke Motor with QuickDraw Harnessing

606-06-100150 QuickDraw 3000 5" Lift Kit (Raises QD 5" for Low Trailers)

606-06-100200 QuickDraw Plant/Stationary Installation Stand

606-06-100300 IBC Shuttle Tie Down Kit - 2 Tie Down Brackets

604-200300 QuickDraw Lite - Pump Stop Kit

604-200100 QuickDraw Lite - 3" Carrier Flow Meter Kit

Power Accessories

206-02-2208Y1 2 Pin - 20' 480 MP Extension Cable-8 AWG

206-02-2209Y1 2 Pin - 30' 480 MP Extension Cable-6 AWG

206-02-2210Y1 2 Pin - 40' 480 MP Extension Cable-6 AWG

208-05-4022Y1 Optima Battery - Red Top Dry Cell

208-02-2191Y1 Power Supply - 25Amp Fused 110VAC to 12VDC with 480 MP Tower Connector

Extended Harness for Mounting User Interface Outside QuickDraw Max (Special Order 4-6 Week Lead Time)

208-05-4313Y1 10' Extended Harness Up Charge

208-05-4314Y1 25' Extended Harness Up Charge

Remote Connectivity (QuickDraw Max Only)

606-05-300150 QuickDraw Remote Connectivity Gateway (1-Time Hardware Purchase)

606-05-300200 1 Year Connection Service Subscription (Annual Data Subscription)



Accessory Kit List (Harnesses, etc.)

208-05-2414Y1	QuickDraw Pump Stop Wiring Harness Set (contains 2 harnesses; 208-05-2802Y1 & 208-05-2633Y1)
208-05-2430Y1	QuickDraw Electric Start Gas Engine 12 Volt Supply Harness (does not start pump)
208-05-2431Y1	QuickDraw electric motor drive pump start harness
208-05-2643Y1	QuickDraw Harness to Coriolis Power Conditioner
208-05-2733Y1	QuickDraw Coriolis to Power Conditioner Harness
208-05-2981Y1	Power Conditioner
208-05-3237Y1	78" Ethernet RJ45 to M12 Adapter Cable
208-05-3285Y2	QuickDraw Modem Power Harness
208-05-3360Y2	QuickDraw Lite Base Harness
208-05-3361Y1	QuickDraw Lite E-Stop Harness
208-05-3362Y1	QuickDraw Lite Motor Stop Adapter
208-05-3363Y2	QuickDraw CAN Valve Expansion Harness
208-05-3774Y1	QuickDraw Hydraulic Booster Pump Harness
208-05-3930Y2	QuickDraw Power Resistor
208-05-3932Y1	QuickDraw AC Booster Pump Harness
208-05-3944Y1	QuickDraw Gas Engine Push Button Start
208-05-3955Y1	QuickDraw Electric Pump Start-Stop Harness Set
208-05-4022Y1	Optima Battery 8022-091 75/25 RedTop Starting Battery
208-05-4240Y1	QuickDraw Transfer Pump Hydraulic Solenoid Start Harness
208-05-4312Y2	QuickDraw 3000 Wiring Harness (MY2021)
208-05-4313Y2	QuickDraw 3000 10 Ft Extended Wiring Harness (MY2021)
208-05-4314Y2	QuickDraw 3000 25 Ft Extended Wiring Harness (MY2021)
208-05-4770Y1	QuickDraw Honda Engine Remote Start Harness
208-05-4771Y1	QuickDraw Honda Engine Speed Select Harness
208-05-4783Y1	QuickDraw Honda Engine Control Final Harness
208-05-4784Y1	QuickDraw Honda iGX Engine Control Adapter Harness
208-05-4859Y1	Electric Carrier Single Valve Control Harness
208-05-4863Y1	QuickDraw Adapter Aux Output to Air Purge
208-05-5115Y1	Optima Blue Top Marine Battery Group 34 55AH Glass Mat
208-05-5127Y1	QD3000 Controller Power Switch Repair Kit

Replacement Parts by Valve P/N

Valve Assembly	103-2101Y1	1" KZ Valve Assembly - CAN Control
Actuator	104-3614Y1	QuickDraw Replacement CAN Actuator for 1" Valve
Valve Body	104-C2F-001	1" QD Product Valve Body Only For 103-2101Y1

Valve Assembly	103-4775Y1	1-1/2" KZ Valve Assembly - CAN Control
Actuator	104-4844Y1	QuickDraw Replacement CAN Actuator for 1.5" Valve
Valve Body	104-T2H22	1.5" KZ Valve Only (Replacement for 1.5" QD Product Valve)

Valve Assembly	103-2102Y1	2" Valve for KZ QD Valve Assembly - CAN Control
Actuator	104-3636Y1	QuickDraw Replacement CAN Actuator for 2", 3" & 4" (butterfly) Valve
Valve Body	104-M2I22	Replacement 220 Flange KZ Valve Body Only

Valve Assembly	103-2415Y1	QuickDraw Rinse Valve, 200 Flange, 1" Thru Ball, WP Shroud
Actuator	104-10DY0-1F1	Replacement Actuator for KZ NH3 Shut-Off Valves (1" thru 1 1/2")
Valve Body	104-C2F33	Replacement Valve Body for 103-2415Y1 and 103-3325Y1 - 200 Flange, 1" Thru Ball

Valve Assembly	103-2416Y1	QuickDraw Venturi Valve, 220 Flange, 2" Thru Ball, WP Shroud
Actuator	104-3636Y1	QuickDraw Replacement CAN Actuator for 2", 3" & 4" (butterfly) Valve
Valve Body	104-M2I22	Replacement 220 Flange KZ Valve for 103-2416Y1

Valve Assembly	103-2417Y1	QuickDraw Valve, 300 Flange, 3" Thru Ball, WP Shroud
Actuator	104-3636Y1	QuickDraw Replacement CAN Actuator for 2", 3" & 4" (butterfly) Valve
Valve Body	104-M2K22	3" QD Valve Only

Valve Assembly	103-3325Y1	1" CAN Actuated Valve, 2-Way, 2" Standard Port Flange
Actuator	104-3614Y1	QuickDraw Replacement CAN Actuator for 1" Valve
Valve Body	104-C2F33	Replacement Valve Body for 103-2415Y1 and 103-3325Y1 - 200 Flange, 1" Thru Ball

Valve Assembly	103-3366Y1	3" KZ Valve Assembly - CAN Control
Actuator	104-3636Y1	QuickDraw Replacement CAN Actuator for 2", 3" & 4" (butterfly) Valve
Valve Body	104-M2K22	3" QD Valve Only

Valve Assembly	103-4944Y1	3" CAN Actuated Butterfly Valve
Actuator	104-3636Y1	QuickDraw Replacement CAN Actuator for 2", 3" & 4" (butterfly) Valve
Valve Body		

Valve Assembly	103-4516Y1	4" CAN Actuated Butterfly Valve
Actuator	104-3636Y1	QuickDraw Replacement CAN Actuator for 2", 3" & 4" (butterfly) Valve
Valve Body		

Replacement Parts by Category

Valve Assembly	
Item Number	Item Description
103-2101Y1	1" KZ Valve Assembly - CAN Control (QuickDraw Product Valve Stack Only)
103-4775Y1	1-1/2" KZ Valve Assembly - CAN Control
103-2102Y1	2" Valve for KZ QD Valve Assembly - CAN Control
103-2415Y1	QuickDraw Rinse Valve, 200 Flange, 1" Thru Ball, WP Shroud
103-2416Y1	QuickDraw Venturi Valve, 220 Flange, 2" Thru Ball, WP Shroud
103-2417Y1	QuickDraw Valve, 300 Flange, 3" Thru Ball, WP Shroud
103-3366Y1	3" CAN Actuated KZ Valve Assembly
103-3325Y1	1" CAN Actuated Valve, 200 Standard Port Flange Adapter
103-4944Y1	3" CAN Actuated Butterfly Valve
103-4516Y1	4" CAN Actuated Butterfly Valve

**All CAN valves have 4-pin Deutsch connector*

Actuator Only	
Item Number	Item Description
104-3614Y1	QuickDraw Replacement CAN Actuator for 1" Valve
104-3636Y1	QuickDraw Replacement CAN Actuator for 2", 3" & 4" (butterfly) Valve
104-4844Y1	QuickDraw Replacement CAN Actuator for 1.5" Valve
104-10DW0-1F1	QuickDraw Replacement CAN Actuator for 103-2416Y1 & 2417Y1
104-10DY0-1F1	Replacement On-Off Actuator for KZ Valves (1" thru 1 1/2")

Valve Body Only	
Item Number	Item Description
104-C2F-001	Replacement Valve Body - 1" KZ Valve (For 103-2101Y1)
104-M2I22	Replacement Valve Body - 2" Full Port, 220 Flange KZ Valve (103-2102Y1, 103-2416Y1)
104-M2K22	Replacement Valve Body - 3" KZ Valve
104-T2H22	Replacement Valve Body - 1.5" KZ Valve (103-4775Y1)
104-C2F33	Replacement Valve Body - 2" Standard Port, 200 Adapter Flange, 1" Ball (103-2415Y1 and 103-3325Y1)

Insert Pages from 5298

SurePoint Ag Systems



Insert Pages from 5298

SurePoint Ag Systems



Insert Pages from 5298

SurePoint Ag Systems



Insert Pages from 5298

SurePoint Ag Systems



Insert Pages from 5298

SurePoint Ag Systems



Insert Pages from 5298

SurePoint Ag Systems



Accessory Kit List (Harnesses)

The accessory harnesses listed below all attach to the main QuickDraw harness, 208-05-2326Y1.

Power harness extensions from vehicle battery

480 MP Extension Harnesses

206-02-xxxxxx

QuickDraw has an internal battery to guarantee adequate power while running. However, it **MUST** be charged from the vehicle electrical system. Each QuickDraw includes a 20' power harness (205-2213Y1) to attach to the vehicle battery. If mounted further from the vehicle battery than 20' and/or crossing a trailer hitch, customer will need an extension harness.

Power harness to supply electric start gas engine transfer pump

QuickDraw Electric Start Gas Engine 12 Volt Supply Harness

208-05-2430Y1

The QuickDraw battery can be used to supply power for an electric start gas engine transfer pump. There is a 480 MP connector on the QuickDraw harness that attaches to this harness. It makes wiring an electric start transfer pump fast and easy without the need for an extra battery or wiring back to the vehicle battery. The harness is 15 feet long.

Pump Stop Harness (for electric or gas engine driven pump)

QuickDraw pump stop harness

208-05-2414Y1

QuickDraw has the ability to turn off the transfer pump. This harness provides a connection to a relay in the QuickDraw harness. The relay is normally closed, it then opens for 10 seconds when the pump is commanded to stop. Connect the harness to any wire on the engine that requires power for the pump to run. Comes with 4 mm bullet terminals which fit some pumps on the market.

Pump Start Harness (for electric driven pumps only)

QuickDraw electric motor drive pump start harness

208-05-2431Y1

QuickDraw can start an electric motor driven transfer pump. This harness provides a connection to a relay in the QuickDraw harness. The relay is normally open, it then closes for 1 second when the pump is commanded to start. Recommended for use along with the pump stop harness above.

QuickDraw Common Troubleshooting Issues

1. Low Voltage (“Comm Loss” / “CAN BUS Valve Failure Alarm”)

Most Common Support Call

Symptom is “Comm Loss” message appearing, followed by “CAN BUS Valve Failure Alarm”

- *Charge the battery. Check harnesses and connections if battery is charging from vehicle.*

2. Low Chemical Flow Rate

Determine if it is one product or all products.

If only one product, investigate the line, tote valve, and product in tote.

If all products are slow, most likely low/no suction from venturi.

- *Make sure ALL valves on educator are closed.*
- *Check for outlet restriction limiting drop across venturi.*

3. Carrier Flowmeter Calibration

Batch volume does not match tank volume.

- *Adjust “Carrier Flow Pulses Per Gallon” on Edit Carrier screen (see page 28)*
- *Calculate % error. Adjust Cal Value by that percentage. Increase Flow Cal if more is needed.*

4. E-Stop Switch Failure

- *Jump wires together, replace switch*

5. CAN Valve Position Sensor Failure

- *Disable valve on system Settings screen, replace Actuator*

6. Air in Mass Meter Warning

If this happens while priming hose, no concern. If message persists on multiple batches, investigate plumbing connections from control valve to tote.

7. Relays (3)- Harness Power, Pump Stop, Pump Start

Power—Should be able to hear this one click about 10 seconds after controller power-up.

If this relay doesn't work, the Valves and 3" Meter, won't power up.

Pump Kill

Pump will not start, or does not shut off Automatically

- *Replace Relay—located on QD main harness under battery tray (available at parts stores)*

8. Fuses (2)- 10A and 50A

- *Check for blown fuses on QD main harness (top left in cabinet). Replace as needed.*

9. Valve will not operate.

- *Check on Settings screen to be sure valve is ENABLED.*

10. Valve communication failure (COMM FAIL)

- Be sure valve is connected to the wiring harness and that the connectors look good.
- Go to the Manual Controls from the Run Screen. Use the controls here to try to control the valve.
- If valve does not operate, try unplugging another valve and plug the valve that is not working into that connector. If the valve works, then the valve is OK, but something is wrong with the harness. If the valve is still not functional, most likely the valve has an issue and needs to be replaced.

11. Replacing a valve

- First, make sure all of the valves are enabled on the System Settings screen. Plug in the new valve. Once the new valve is detected the QuickDraw controller screen should change to a valve commission screen. If the valve number shown on this screen matches the valve that is missing, then hit continue to address the new valve. If it is not then enter the correct valve number and press continue. This will configure the valve to the correct valve number.
- After configuring a new valve go to the Manual Controls screen from the Run screen and make sure all valves are operating and that they are operating in the correct position. Make sure that valve 1 is 1 and 2 is 2 and so forth.

12. Mass Meter Power Conditioner / Safety Barrier

Optional Modem goes in this box, also.



Front Red light should be ON.

Top (gray) terminal block:

Power from QD Controller:
Red to Black 24 volts

Bottom (blue) terminal block:

Power to the Mass Meter:
Red to Black 14 to 15 volts

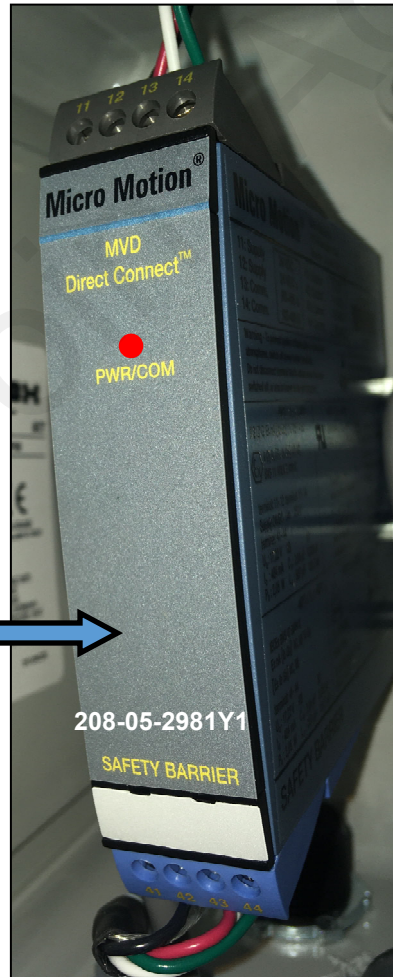

Scan the QR Code at the left or click on the QR Code at the left to go to the SurePoint Ag YouTube Channel to see videos on the operation of the QuickDraw 3000.

Winterization Procedure

QuickDraw 3000 Winterization Procedure

The following is the Winterization Procedure for QuickDraw 3000. Use RV AntiFreeze. 5-10 gallons should be sufficient to winterize the system. This winterization process is best used during early spring and late fall periods when still actively using the system to tender. Over-winter it is recommended to keep your QuickDraw inside a temperature controlled building. If this is not possible, utilize winterization procedure and then remove Control Console (User Interface) and keep inside.

1. To pump antifreeze you can use your transfer pump or an electric pump plumbed to the winterization port (#1) on the inlet fitting of the QuickDraw. If using an electric pump, you'll need to stop flow from going to your transfer pump. This can be done by installing a valve that can be closed or by disconnecting the inlet hose from the transfer pump to the QuickDraw and putting a 3" Cap on the Inlet (#2)
2. Use "Manual Controls" on controller to open "Rinse Valve"
3. Pump Antifreeze into the QuickDraw Pump Inlet until product is discharged from Quick Draw Outlet.
4. Use "Manual Controls" on controller to close "Rinse Valve"
5. Use "Manual Control" to open each of "Product Valves" (4, 6, or 9 valves depending on your system). Antifreeze should discharge from each valve.
6. Open the "Product Hose Rinse" and "Eductor Supply" valves. Antifreeze should discharge, if not, pump antifreeze until it does. Close valves.
7. Use manual controls to open "2" Venturi Valve" and "3" By-Pass Valve". Antifreeze should discharge from QuickDraw outlet when each of these valves open. If Antifreeze does not discharge when the valves open, pump additional antifreeze until it visibly discharges from QuickDraw outlet.
8. Open and drain 2 valves located at bottom of mass meter (right of controller).
9. **NOTE** - Using only compressed air will not get all water out of the QuickDraw plumbing. To ensure no damage occurs from freezing, it is necessary to use antifreeze.

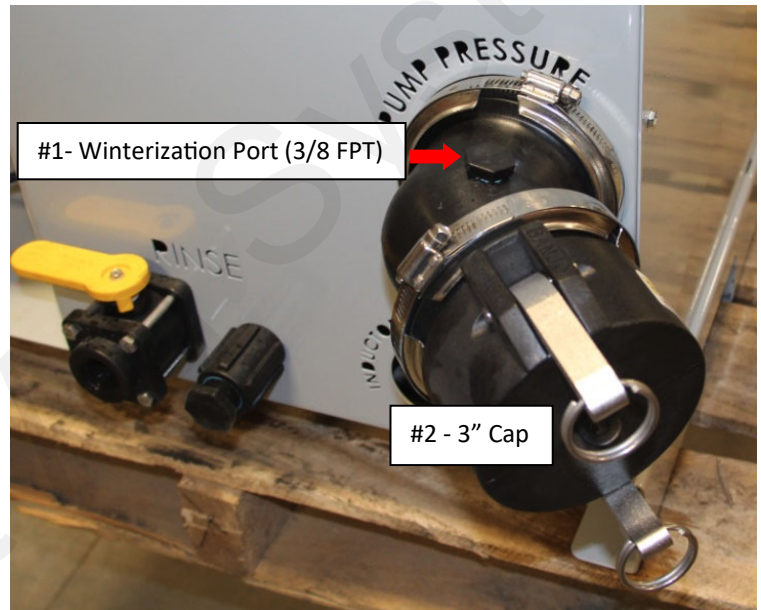

Winterization (or overnight in the cold)

It is important to protect the components of the QuickDraw from freeze damage when the QuickDraw will be in an environment subject to freezing temperatures.

The QuickDraw 3000 is plumbed with a drain system that will allow the critical components to be drained if the unit will be in freezing temperatures. The drain system is a 1/4' tube with two 1/4-turn manual valves that can be opened. To provide better drainage, the electric rinse valve must be opened along with the manual product hose rinse valve, eductor supply valve, and rinse valve.

If the QuickDraw is not level, be sure that all critical components are protected from freeze damage.

For complete and/or long-term protection, run RV Anti-freeze or Sprayer Anti-freeze through the system.

1. Be sure it is safe to dispense the liquid from the 1/4" drain tube.
2. Open the two 1/4-turn drain valves (beside or behind the QD Controller).
3. On the outside of the QD cabinet, open the Product Hose Rinse Valve, Eductor Supply valve, and Rinse Valve.
4. Go to Run Screen > Manual Controls > Rinse Valve > ON
5. Be sure any other hoses, fittings, components, etc are protected from freeze damage.
6. Before using, close all the valves that were opened and be sure all hoses are secured.

1/4" drain tube



Be sure the outlet of the drain tube is in a place where it is safe to discharge the liquid that will be drained.

Follow the 1/4" tube back into the cabinet to find the two 1/4-turn valves that will be opened to drain the system.

Be sure the valves are closed before the system is used again.

Drain valves: Inside cabinet, bottom right >



Software Update

Go to the SurePoint Support website (support.SurePointag.com/products/218)
Go to Home/Categories/Spray Tender Products/QuickDraw 3000 Max/QuickDraw 3000 Max (10/2019-Present)

On the right-hand side of the screen there are links to download different documents. One of the sections is titled “Software Update”, under which will be “QuickDraw 3000 Display Controller Firmware V.....” and “QuickDraw 3000 Display Software Update V”. Click on both links to download the software to your computer.



Software Update

- QuickDraw 3000 Display Software Update V1.17
- QuickDraw 3000 Controller Firmware V 2.3.7
- QuickDraw 3000 Software Update Instructions



Open the File Explorer on your computer and go to Downloads. Copy the 2 files that you downloaded in the previous step and paste them in your USB drive.

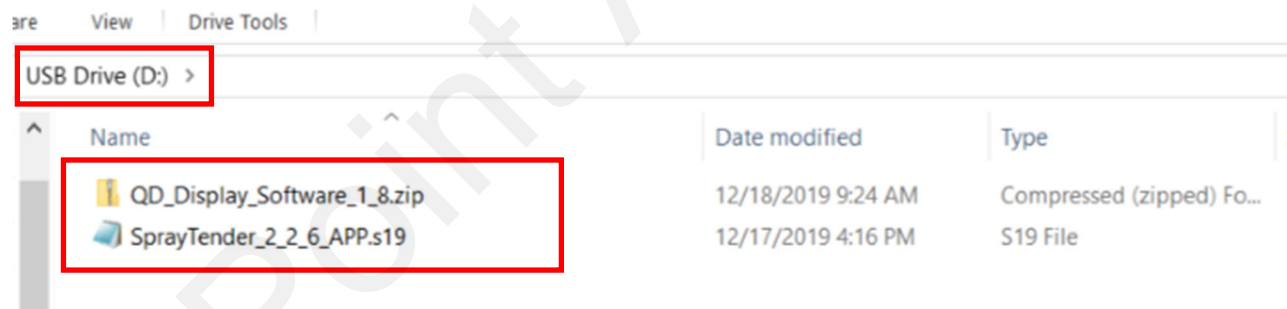

At this point the files on the USB stick should look similar to:

On the **QuickDraw controller** go to MENU->MAINTENANCE and look at the Display Rev:

If the Display Rev is less than 1.8, the QD_Display_Software_x_x.zip File on the USB will need to

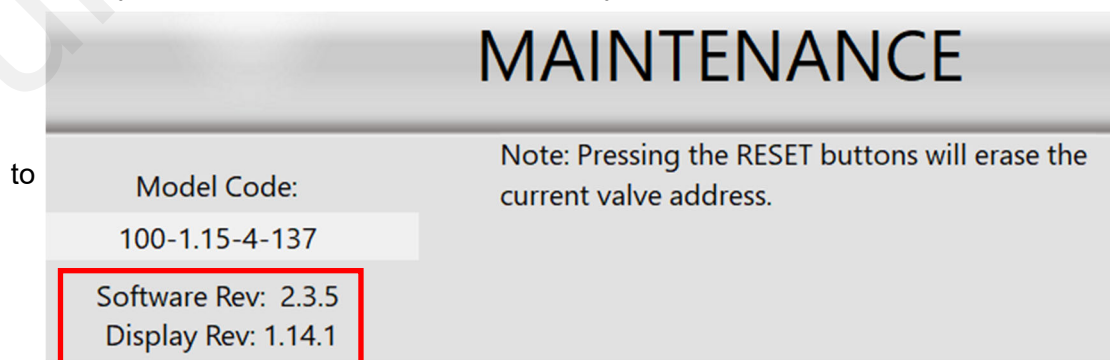

be re-named. Change the name

Eject the USB from your computer and insert it into the QD3000 controller. Then go to the MENU screen on the QD3000 controller. This will bring up the following screen:

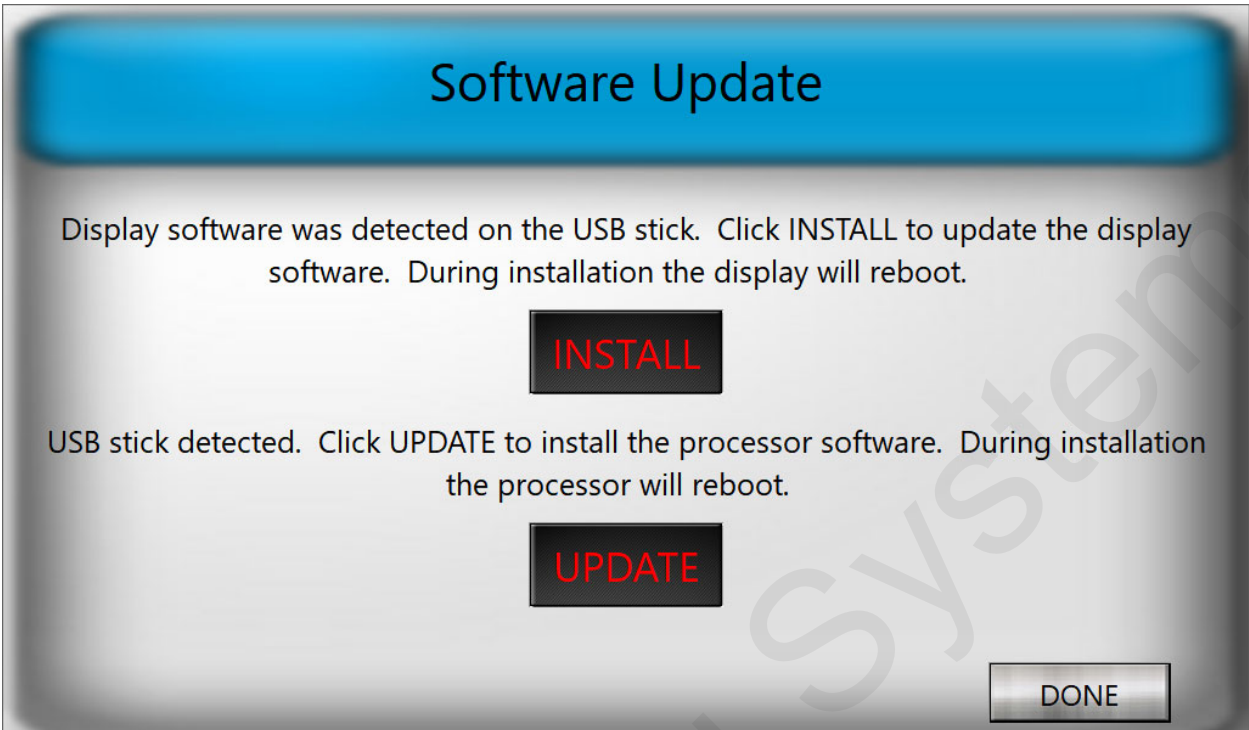

Click on the INSTALL button to update the display software. Select the file with the Display software. The install will take several seconds during which time the display will turn off and then back on. Once the display software has been updated, the QD3000 controller will return to the RUN screen. Go back to the MENU screen and wait for the Software Update screen to be displayed. Click on the UPDATE button. The following screen will then be displayed:

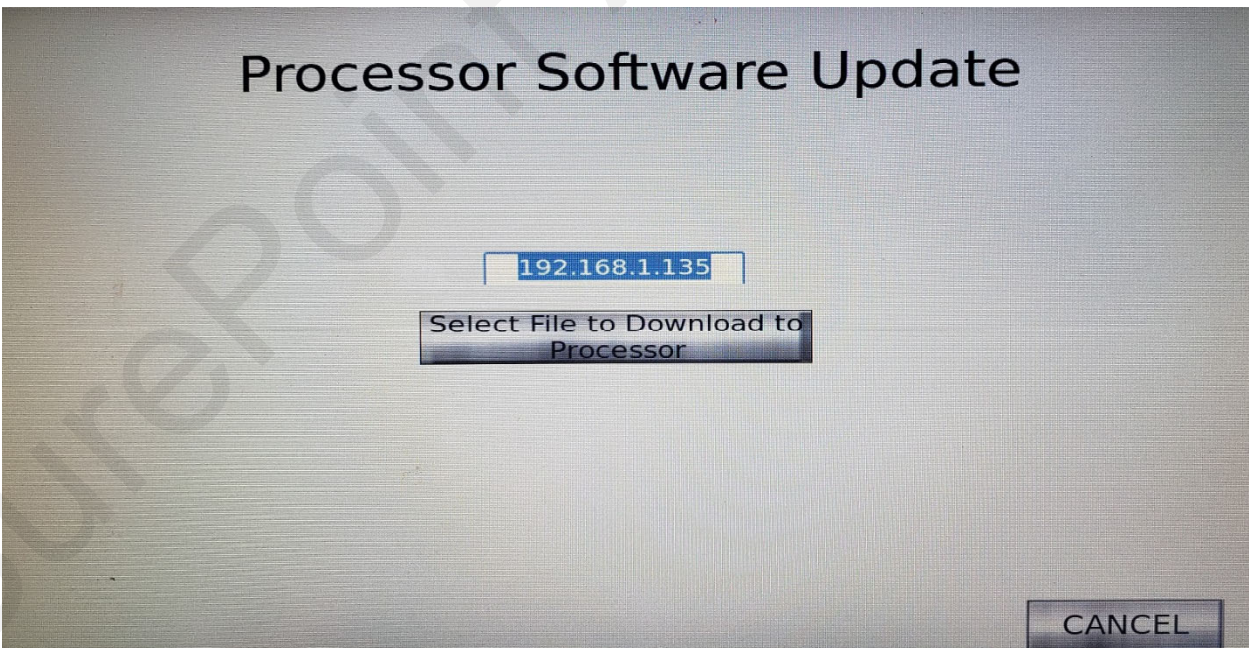

If the box that contains 192.168.1.135 above contains 0, enter 192.168.1.135. Otherwise/then click "Select File to Download to Processor". This will bring up the following screen:

Software Update (continued)

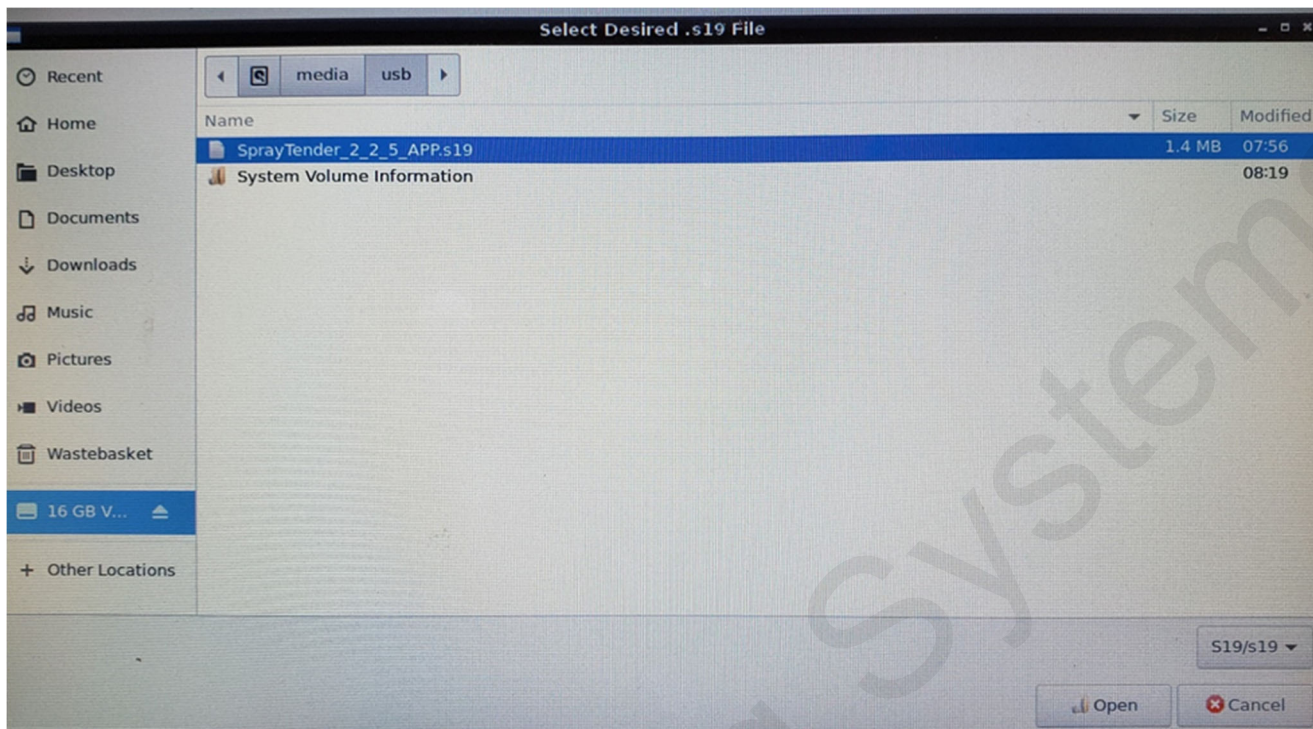

The file ending in “.s19” should be highlighted in blue, as shown above. If it is not, click on it. Then hit Open in the bottom right-hand corner of the screen.

After several seconds the following box will appear, indicating that the software is downloading:

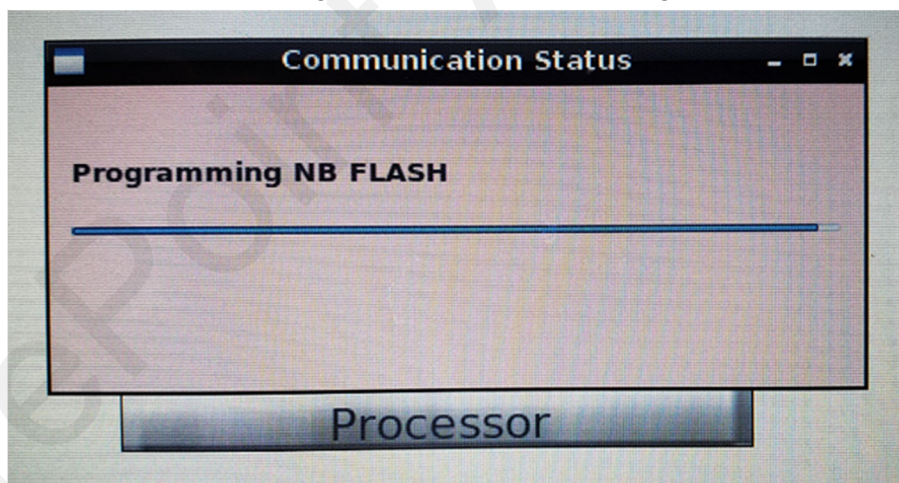

Once the software has been successfully downloaded, the box shown above will display :
“All Done – Rebooting”.

You can then hit OK and exit out of all the screens until you get to the MENU screen.

Finally, remove the USB stick from the QD3000 controller.

Glossary of Terms

Alarm—An indication that something is wrong that will prevent the batch from running. The problem indicated by the Alarm must be fixed before the batch will run.

Batch—A combination of carrier (water) plus chemicals that will be measured and put in the sprayer at a specific moment in time for a specific use.

Calculation Mode—The method that the QuickDraw controller will use to calculate the amount of carrier and the amount of each product (chemical) that is needed for a batch. The 4 modes are Gallons and Application Rate, Acres and Application Rate, Volume, and Acres and Carrier Rate.

Carrier—Typically water. Could be a liquid fertilizer product that is used as the carrier liquid in a spray batch. QD3000 can be set up for up to 4 carriers (Carrier Blending).

E-stop—Emergency stop. Push the red button on the front of the QuickDraw cabinet to close the valves and stop the loading process. If wired to do so, this will also kill the pump. Twist to reset.

Field and Weather—A place to enter optional information for the batch history record. This includes Grower, Farm, Field, Operator, Crop, Machine, Pest, Temperature, Wind Speed/Direction, and Boom Height.

Final Rinse—A flushing of the product valve stack header after all chemicals have been dispensed. The Default and Minimum is 10 seconds. It can be set for a longer time if desired.

Hidden (Advanced Settings) Screen—A screen that can be accessed by pressing to the left of the Battery Voltage on the Settings Screen.

History—The record of each batch that is made. Contains Batch ID number, Farm, Field, Recipe, Date, Time, Wind Speed and Direction, Temperature, Products used, rate per acre and total amount of each product, rate per acre and total amount of carrier, name and EPA ID of each chemical product, Total volume of batch, application rate intended for batch, and number of acres batch was mixed for. The history will be transferred from the controller to the iPad, and then can be emailed as an HTML or as a csv file.

Job—All the information needed to create a batch. The Job has the information of Farm, Field, Recipe, carrier and product (chemical) names and rates, mixing order, pre-rinse time, volume of product to use, how much carrier to preload to the sprayer, calculation mode used, total acres, total volume, application rate.

Job Screen—The screen that shows all the information for the current Job (Batch). The size of the batch, the App Rate, the PreLoad Volume, and the Rate for each product can be set or changed on this screen.

Manual Controls—A screen where the operator is able to manually open/close any of the valves.

Manual Products—These products include small-package liquids, dry flowables, and powders. Each recipe can include up to 5 manual products. They are part of the recipe and are manually added to the batch. Also, low-volume liquids will be added manually (Venturi Suction system—0.5 gal or less. Pump Suction system—1.0 gal or less.)

Mass Meter—The Micro Motion mass flowmeter used to measure the product dispensed.

Mix—Same as recipe.

Glossary of Terms

Pre-Load—An amount of carrier that will be pumped into the sprayer before any chemicals are added.

Prime Disabled / Prime Enabled—In normal operation, if the QD does not read flow on a product for 10 seconds, the QD will shut down and an Alarm will show: Product Flow Failure. When a new tote is connected, it may take longer than 10 seconds for the product to fill the hose and reach the meter. To prevent the Product Flow Failure timeout, PRIME ENABLED extends the time to read flow to 30 seconds for the first batch only. To activate this, on the RUN SCREEN press the tote, then press PRIME DISABLED to change it to PRIME ENABLED.

Prod Rinse—A flushing of the product valve stack header with carrier prior to the addition of a chemical. Designed to prevent any unwanted mixing of chemicals prior to reaching the sprayer. Typically, this is set as a 3-5 second rinse. The Default and Minimum is 3 seconds. It can be set longer if desired.

Product—A chemical (could be a herbicide, insecticide, pesticide, etc.) that will be mixed into a spray batch. A product can either be in a tote attached to a QuickDraw valve to be automatically dispensed into the mix or can be a manually added product (can be liquid or dry).

Product Hose Rinse—This feature will allow the operator to rinse a product hose while a batch is running. The operator can enter the hose size and length so that the amount of chemical in the hose can be accounted for in the batch. The water used in the rinse will also be measured as part of the batch.

Pump Suction—The transfer pump is located on the Quick Draw outlet. Suction from the pump is utilized to draw chemical products through the mass meter and into the batch. (See Venturi Suction)

Recipe—A set of instructions that tells which carrier and which products (chemicals) to use, the rate per acre to use, the order in which they should be added, and the pre-rinse time for each product.

Run Screen—The screen on the controller or iPad app that will be used to START a batch and where the progress of the batch will be displayed.

SSID—The WI-FI network name to which the iPad will connect to interact with the QuickDraw controller.

Terminate Batch—An option that will be offered by the controller when the batch is paused either by the operator or by an Alarm. The batch will be stopped where it is. The historical record will show what has been entered into the batch and that the batch was Terminated.

Tote—Tote, shuttle, or tank that holds a chemical that is connected to one of the QuickDraw valves and that will be metered automatically into a batch.

Venturi Suction-- The transfer pump is located on the QuickDraw inlet. It pushes water across a venturi to create suction which draws chemical products through the mass meter and into the batch. This is the most typical QuickDraw 3000 setup. (See Pump Suction)

Warning—An indication of a potential issue that may require operator attention.



396-4495Y1 QuickDraw^{MAX} 3000 Master Wiring Overview

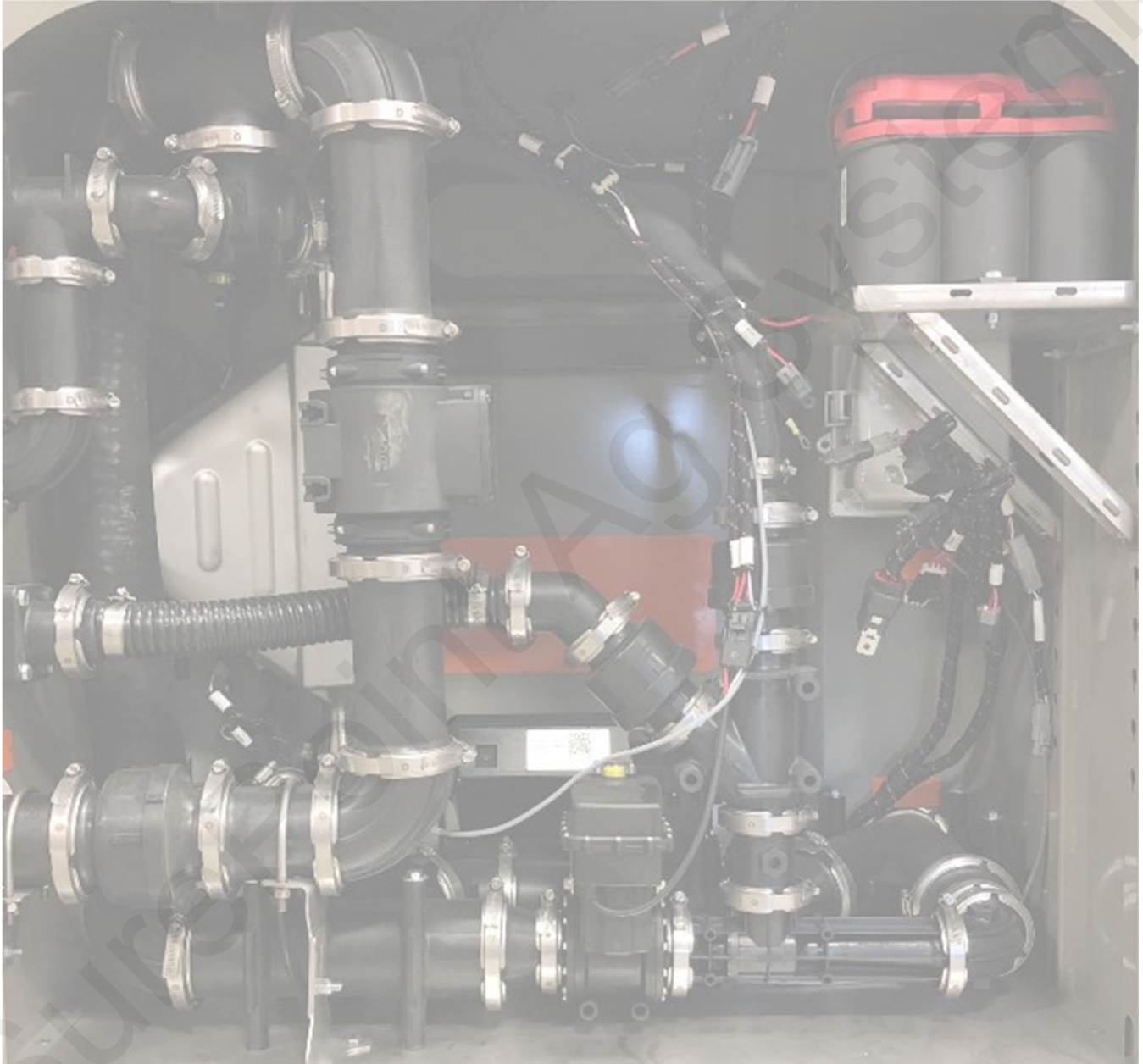
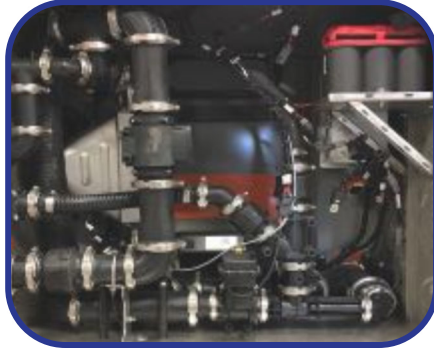

Table of Contents



QuickDraw Main Harness
(Page 4)



QuickDraw Power Wiring
(Page 5)



Gas Engine Wiring
(Pages 6-10, 17)



Electric Motor Wiring
(Pages 11-13, 17)



Hydraulic Motor Wiring
(Pages 14-16, 17)



Remote Connectivity
(Page 18)



Multiple Carrier
(Page 19-20)



Hose Reel Wiring
(Page 21)



Electric Carrier Fill Valve
(Page 22)



QuickDraw Harnessing Table of Contents

QuickDraw Harnesses

- QuickDraw Main Harness
 - 208-05-4312Y1 - 12" Controller Leg (Standard)
 - 606-05-400100 - QuickDraw Extended Harness Kit - 10' Controller/E-Stop Extension
 - 606-05-400200 - QuickDraw Extended Harness Kit - 25' Controller/E-Stop Extension

Power Connections

- Requires 208-NAPA7578 - 12 Volt Battery, BCI Group 78 (Or customer provided battery)
- 205-2213Y1 - 40 Amp 480MP Power Cable - 20' 6AWG
- 208-02-2191Y1 - Power Supply - 25Amp, 110VAC to 12VDC with 480 MP Tower Connector
- 206-02-220_Y1 - 2 Pin - 480MP Extension Cables
 - 5 Foot: 206-02-2206Y1 (10 AWG)
 - 10 Foot: 206-02-2207Y1 (8 AWG)
 - 20 Foot: 206-02-2208Y1 (8 AWG)
 - 30 Foot: 206-02-2209Y1 (6 AWG)
 - 40 Foot: 206-02-2210Y1 (6 AWG)
 - 60 Foot: 206-02-2211Y1 (6 AWG)
- 201-4241Y1 - 40A Y Cable: 480MP Tower to (2) 480MP Shroud

Gas Engine Pumps

- 208-05-2414Y1 - QuickDraw Pump Stop Harness Set (See Manual 396-2944Y1)
 - 208-05-2802Y1 - QuickDraw Pump Stop Harness
 - 208-05-2633Y1 - QuickDraw Pump Stop Harness (Grounded Coil)
- 208-05-2430Y1 - QuickDraw Electric Pump Start Gas Engine 12V Supply Harness
- 208-05-3944Y1 - QuickDraw Gas Engine Push Button Start
- 208-05-4783Y1 - QuickDraw iGX390 Honda Engine Control Final Harness
- 208-05-4784Y2 - QuickDraw iGX Honda Engine Control Adapter Harness

Electric Pumps

- 208-05-3955Y1 - QuickDraw Electric Pump Start-Stop Harness (See Manual 396-3684Y1)
 - Stop/Start Starter Panel with QuickDraw Start and Stop Harnesses Installed
 - On/Off Motor Starter with QuickDraw Start and Stop Harnesses Installed

Hydraulic Pumps

- 208-05-3774Y1 - Hydraulic Booster Pump Harness
- 208-05-4240Y1 - Hydraulic Transfer Pump Solenoid Start Harness

Remote Connectivity (Cloud Based Connections)

- 606-05-300150 - QuickDraw Remote Connectivity Kit

Multiple Carrier Valve Wiring

- 208-05-3363Y2 - QuickDraw CAN Valve Expansion Harness
- 206-04-291_Y1 - 4-Pin Deutsch Extension Cable
 - 5 ft - 206-04-2913Y1
 - 10 ft - 206-04-2914Y1
 - 20 ft - 206-04-2915Y1

Hose Reel

- Requires 208-NAPA7578 - 12 Volt Battery, BCI Group 78 (Or customer provided battery)
- 205-2213Y1 - 40 Amp 480MP Power Cable - 20' 6AWG
- 201-4241Y1 - 40A 480MP Tower x 2 480MP Shroud Y Cable

Electric Carrier Fill Valve Kit

- 208-05-4193Y1 - Electric Carrier Fill Valve Control Harness

QuickDraw Main Harness

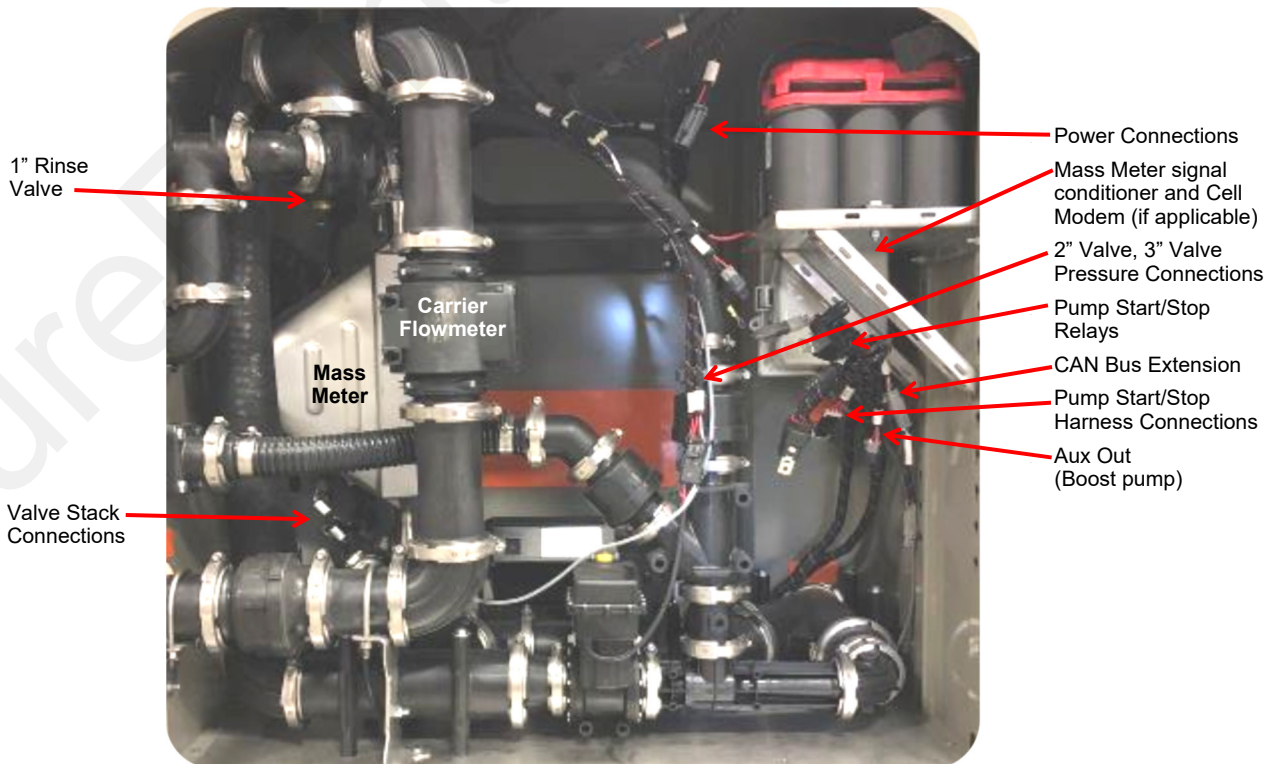
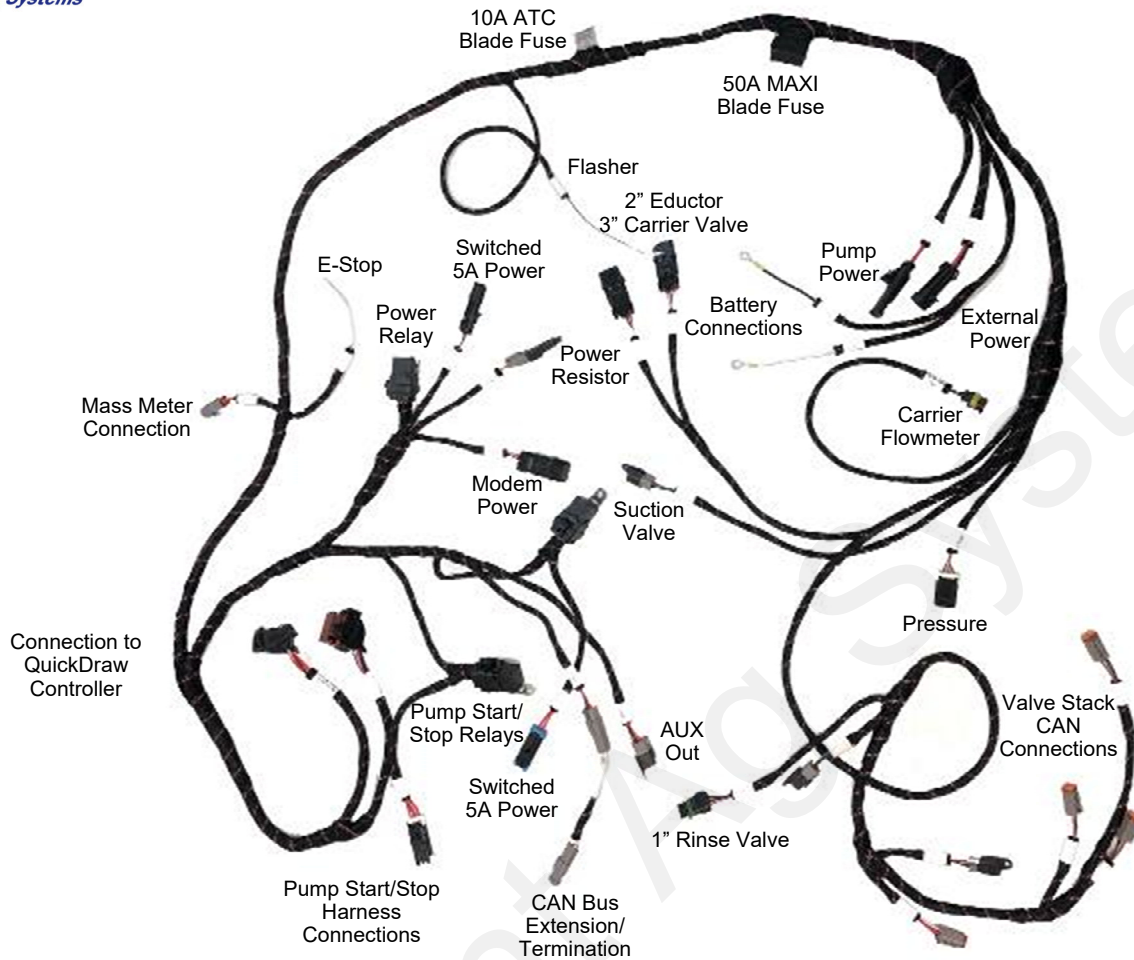



Power Connections

Power Essentials

- 208-NAPA7578 - 12 Volt Battery, BCI Group 78
- 205-2213Y1 - 40 Amp 480MP Power Cable - 20' 6AWG
- 206-02-220_Y1 - 2 Pin - 480MP Extension Cable
 - 5 Ft: 206-02-2206Y1 (10 AWG)
 - 10 Ft: 206-02-2207Y1 (8 AWG)
 - 20 Ft: 206-02-2208Y1 (8 AWG)
 - 30 Ft: 206-02-2209Y1 (6 AWG)
 - 40 Ft: 206-02-2210Y1 (6 AWG)
 - 60 Ft: 206-02-2211Y1 (6 AWG)

QuickDraw Power Connections:

1. Install battery and tighten battery hold downs. *Note: Battery is not always provided by SurePoint due to shipping constraints.*
2. Connect the ring terminals of the 205-2213Y1 harness to the truck/tractor battery and route to the trailer hitch or disconnection point.
3. Use the appropriate length or combination of 2-pin 480MP extension cables to route from the hitch to inside the QuickDraw. 20 ft is most commonly used.
4. Connect the extension harness to the connector inside the QuickDraw labeled **External Power**.

* In lieu of a battery and harnessing in stationary/plant applications a 110V to 12V power supply is used. SurePoint P/N: 208-02-2191Y1 - Power Supply - 25Amp, 110VAC to 12VDC

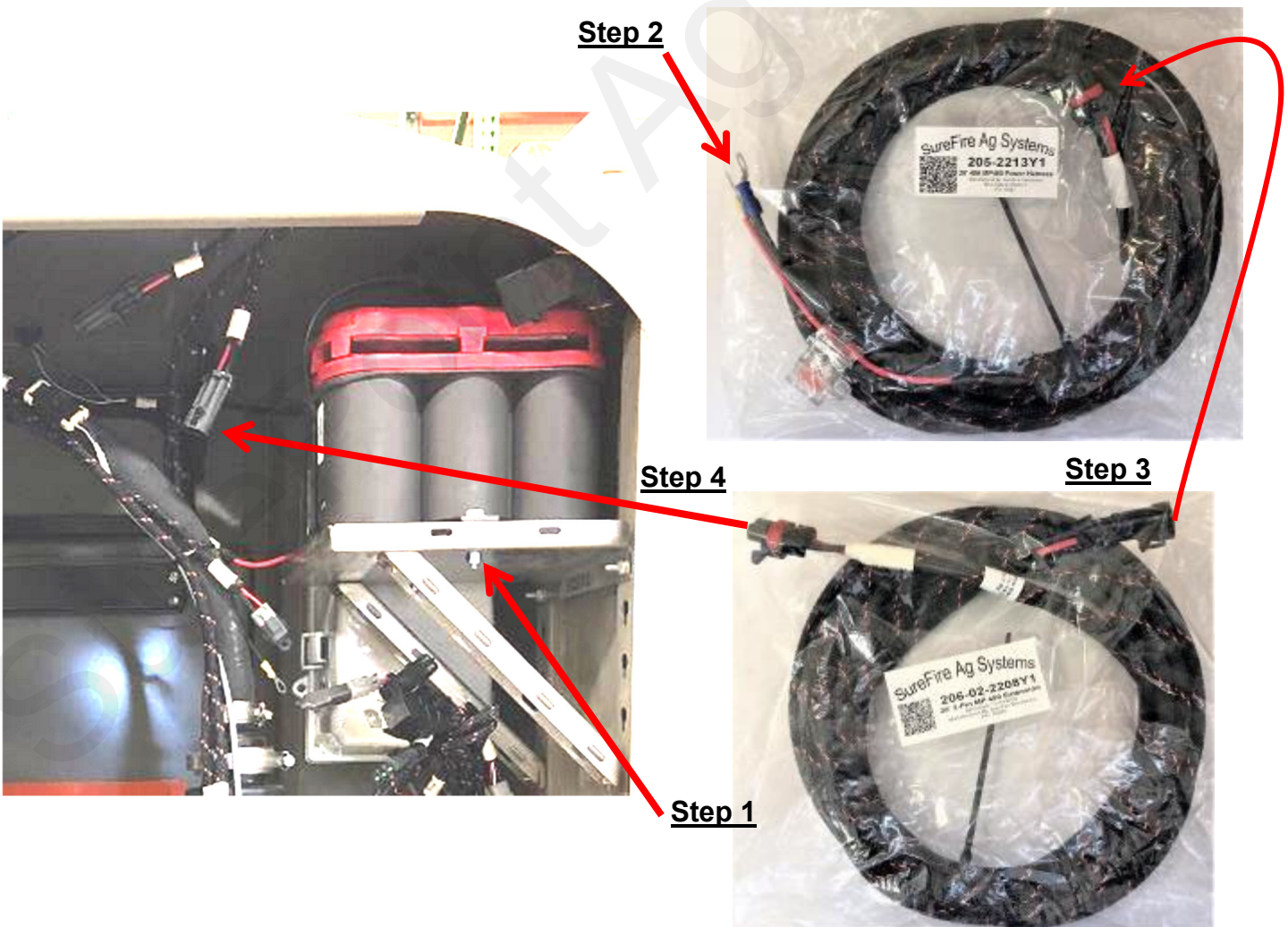



Gas Engine Pump Start/Stop and Power

Generic Pump Wiring Essentials

- 208-05-2414Y1 - QuickDraw Pump Stop Harness Set (See Manual 396-2944Y1)
 - 208-05-2802Y1 - QuickDraw Pump Stop Harness
 - 208-05-2633Y1 - QuickDraw Pump Stop Harness (Grounded Coil)
- 208-05-2430Y1 - QuickDraw Electric Pump Start Gas Engine 12V Supply Harness
- 208-05-3944Y1 - QuickDraw Gas Engine Push Button Start

QuickDraw Honda iGx390 Pump Wiring

- 208-05-4784Y2 - QuickDraw iGX Honda Engine Control Adapter Harness (Page 9)
- 208-05-4783Y1 - QuickDraw iGX390 Honda Engine Control Final Harness (Page 10)

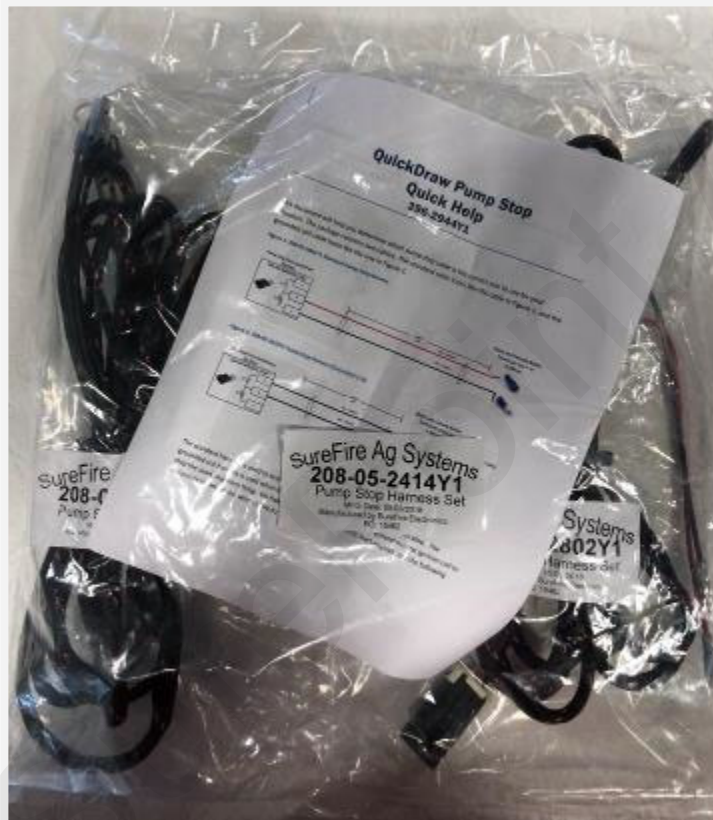

**208-05-2430Y1
QuickDraw Electric
Pump Start Gas Engine
12V Supply Harness**



**208-05-3944Y1
QuickDraw Gas Engine
Push Button Start**

Gas Engine Pump Start/Stop and Power Wiring

Pump Connections:

1. First, follow the steps on 396-2944Y1 - QuickDraw Pump Stop Quick Help guide (located inside the 208-05-2414Y1 harness bag) to determine whether to use the standard or grounded pump stop harness. Use those instructions to connect the bullet connectors properly for your motor.
2. Connect the ground wire from the 208-05-2430Y1 harness, and pump stop grounded ring terminal if applicable, to motor ground.
3. Connect 12V power from 208-05-2430Y1 12V supply harness and 208-05-3944Y1 Push button start power cable (Red Ring Terminal) to the motor coil as shown.
4. Remove the spade connector with black boot from the coil and connect the female spade connector of the 208-05-3944Y1 Push Button Start harness to the coil and the male connector to the boot previously removed.

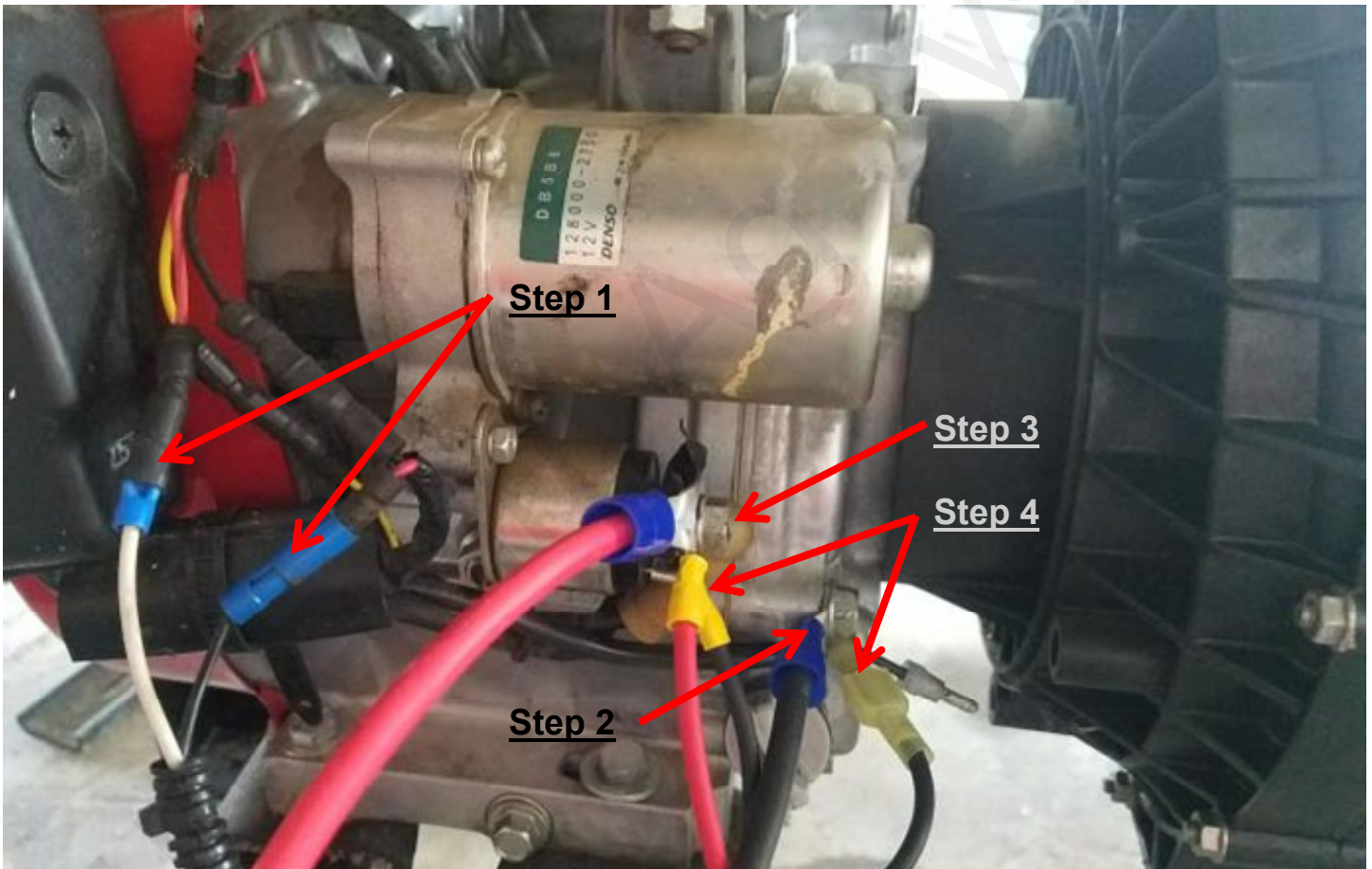

**See page 9 for Honda iGX390 AutoChoke pump wiring*



Gas Engine Pump QuickDraw Harness Connections

QuickDraw Connections:

1. Route Pump Stop harness (P/N 208-05-2802Y1 or 208-05-2633Y1) inside the QuickDraw cabinet and connect 150MP Shroud to male connector labeled **Pump Stop**. *Note: The connector may have a dust cap that needs to be removed.*
2. Route 12V Pump Power Harness (P/N 208-05-2430Y1) inside the QuickDraw cabinet near the battery mount and connect to **Pump Power** on the main QuickDraw Harness. *Note: The connector may have a dust cap that needs to be removed.*
3. Route 208-05-3944Y1 QuickDraw Push-Button Start Harness to inside the QuickDraw cabinet (or other desired start location). Install 475-4266Y1-SS - QuickDraw Aux Switch mounting bracket by removing 1/4" bolt for Product Valve label, then re-use bolt and install mounting bracket. Mount pump start button in the mounting bracket.
4. In the QuickDraw controller system settings, change the **Pump Start Mode** to MAINTAINED START.



Step 2
Pump Power

Step 3
Push-Button
Start

Step 1
Pump Stop



606-03-500100

Honda iGX390 AutoChoke Motor with QuickDraw Harnessing

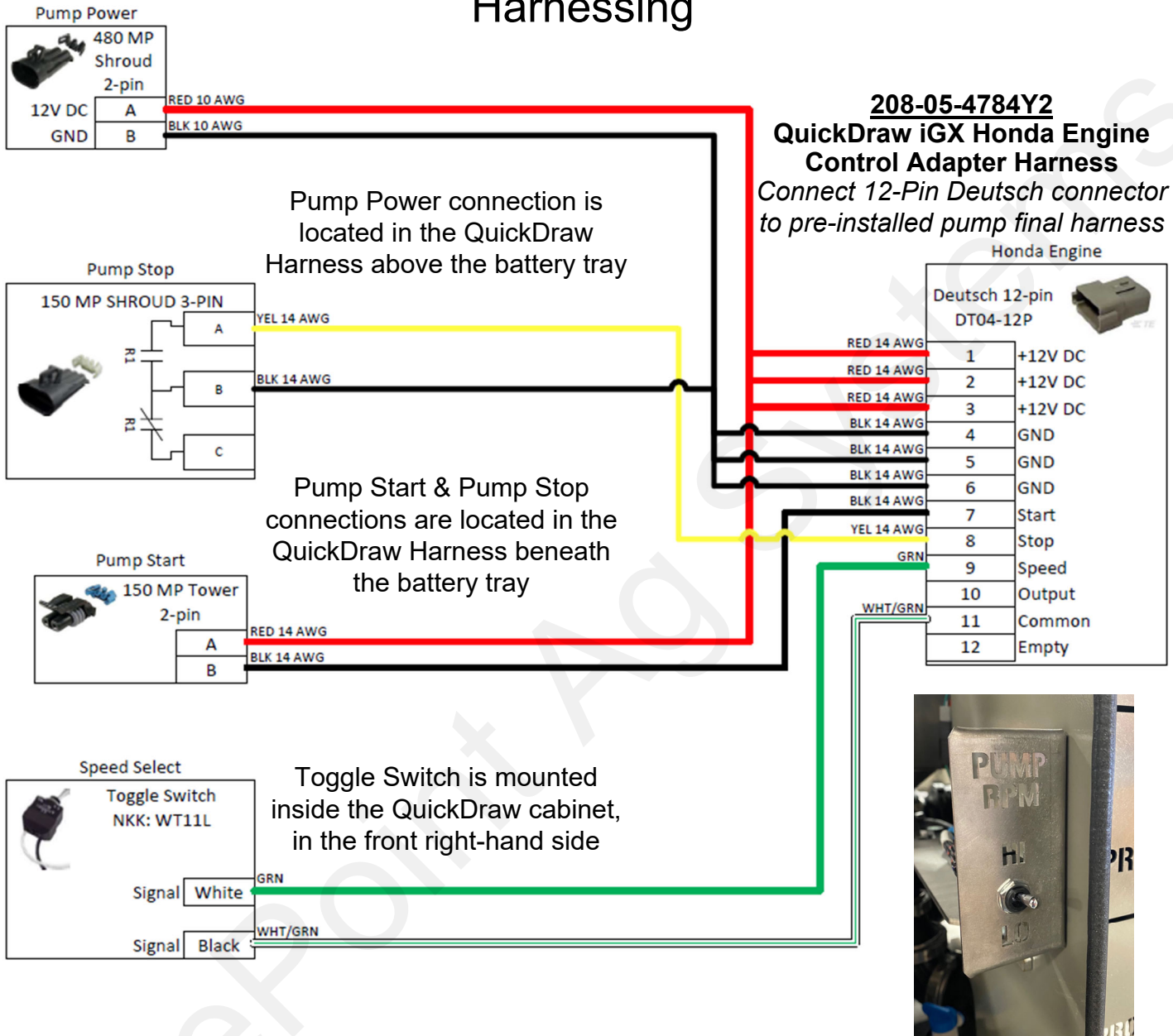

Pump Start Operation (QuickDraw Operation):

When starting and warming up the engine, you do not need to operate the choke lever unless the engine is hard to start using the normal operating procedure.

1. Check the oil level. If it is below the upper limit, fill with the recommended oil to the upper limit.
2. Move the fuel valve lever to the **ON** position.
3. Turn the engine switch to the **ON** position.
4. The pump will start when the QuickDraw Batch is started., and stop when the batch is completed.
5. Flip the RPM toggle switch for High or Low



iGX390 Pre-Installed Wiring Harness Diagram

208-05-4783Y1

QuickDraw iGX390 Honda Engine Control Final Harness

12-Pin Connector for SurePoint/
QuickDraw Harness options

Deutsch 12-pin DT06-12S		
+12V DC	1	RED 14 AWG
+12V DC	2	RED 14 AWG
+12V DC	3	RED 14 AWG
GND	4	BLK 14 AWG
GND	5	BLK 14 AWG
GND	6	BLK 14 AWG
Start	7	BLK 14 AWG
Stop	8	YEL 14 AWG
Speed	9	GRN
Output	10	WHT/GRN
Common	11	WHT/GRN
Empty	12	

12-Pin Connector for Control Box or
SurePoint QuickDraw Control Harness
**Use 12-pin extensions as needed to extend
QuickDraw harnessing to the pump location.*

- 206-12-3435Y1**- 10' Extension Cable
- 206-12-3436Y1**- 20' Extension Cable
- 206-12-3437Y1** - 30' Extension Cable

Speed Select Connections:
Green - Green
White/Green - Light Green

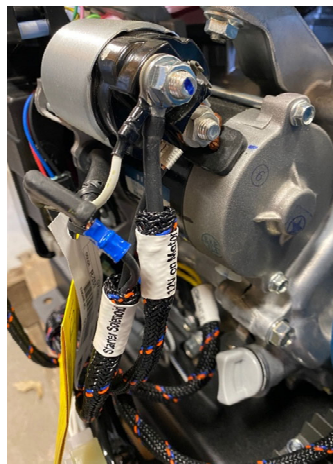
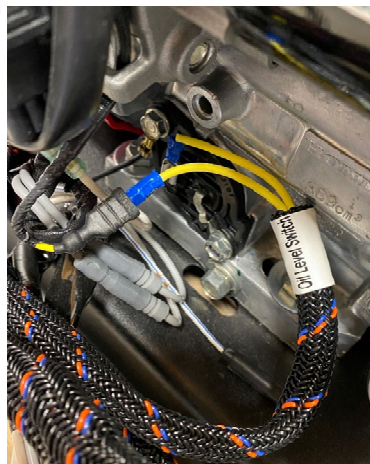
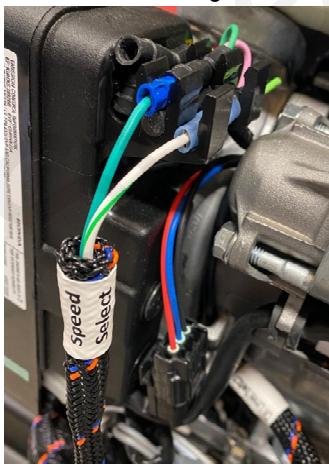
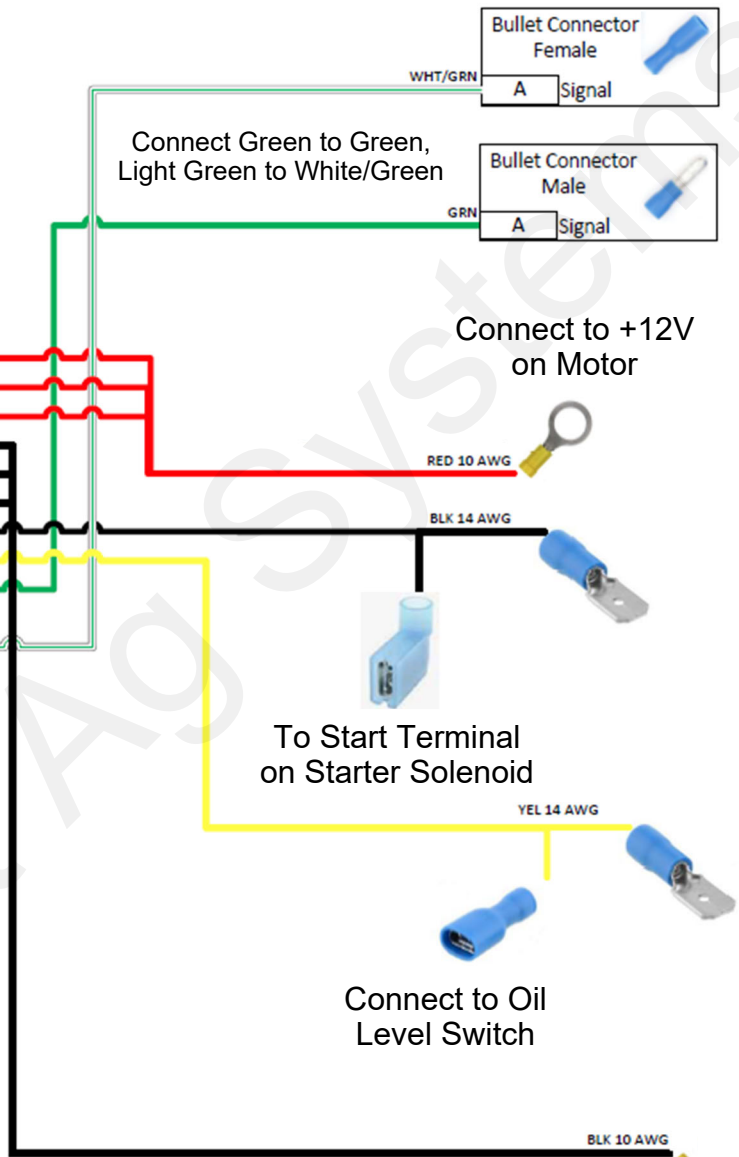

Electric Pump Start/Stop Wiring Overview



Pump Start and Pump Stop Connections

1. 208-05-2431Y1 - QuickDraw Electric Motor Drive Pump Start Harness (Connect to **Pump Start**)
2. 208-05-2802Y1 - QuickDraw Pump Stop Harness (Connect to **Pump Stop**)
3. See the following pages for Motor Control Panel Wiring.
4. In the QuickDraw controller system settings, change the **Pump Start Mode** to either **Momentary** or **Maintained**, depending on motor control panel wiring. See Page 15.

WARNING!

WIRING AN ELECTRIC MOTOR TO A CUSTOMER SUPPLIED MOTOR CONTROL PANEL AND THE QUICKDRAW MUST BE PERFORMED BY AN ELECTRICIAN. TYPICAL MOTOR CONTROL PANEL WIRING SCHEMATICS ARE SUPPLIED, BUT THE CUSTOMER IS RESPONSIBLE FOR PROVIDING THEIR OWN MOTOR CONTROL PANEL AND WIRING. SUREPOINT AG SYSTEMS DOES NOT SUPPLY THIS EQUIPMENT.

Electric Pump Stop/Start Starter Panel Wiring Diagram

WARNING!

WIRING AN ELECTRIC MOTOR TO A CUSTOMER SUPPLIED MOTOR CONTROL PANEL AND THE QUICKDRAW MUST BE PERFORMED BY AN ELECTRICIAN. TYPICAL MOTOR CONTROL PANEL WIRING SCHEMATICS ARE SUPPLIED, BUT THE CUSTOMER IS RESPONSIBLE FOR PROVIDING THEIR OWN MOTOR CONTROL PANEL AND WIRING. SUREPOINT AG SYSTEMS DOES NOT SUPPLY THIS EQUIPMENT.

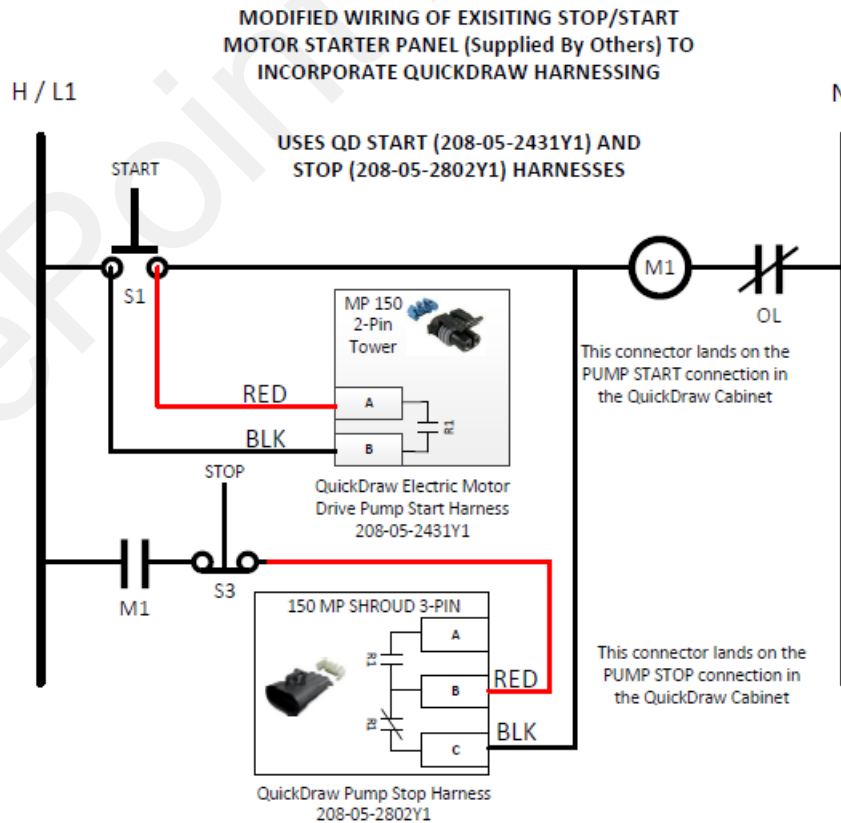
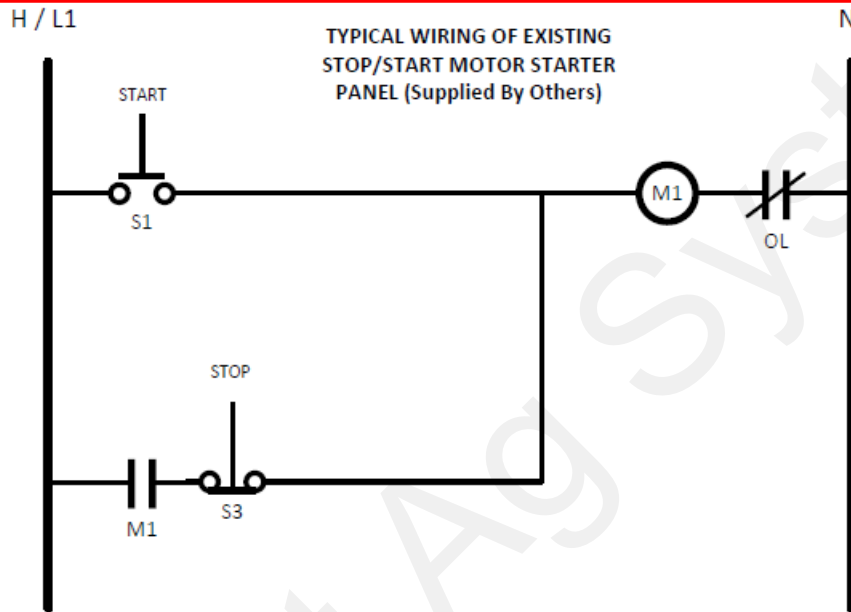

Electric Pump Hand/Off/Auto Motor Starter Panel Wiring

WARNING!

WIRING AN ELECTRIC MOTOR TO A CUSTOMER SUPPLIED MOTOR CONTROL PANEL AND THE QUICKDRAW MUST BE PERFORMED BY AN ELECTRICIAN. TYPICAL MOTOR CONTROL PANEL WIRING SCHEMATICS ARE SUPPLIED, BUT THE CUSTOMER IS RESPONSIBLE FOR PROVIDING THEIR OWN MOTOR CONTROL PANEL AND WIRING. SUREPOINT AG SYSTEMS DOES NOT SUPPLY THIS EQUIPMENT.

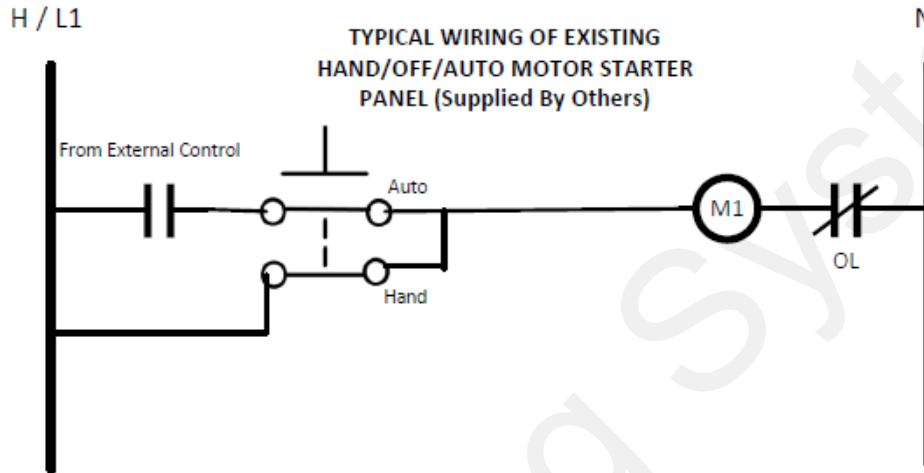

MODIFIED WIRING OF EXISTING HAND/OFF/AUTO
MOTOR STARTER PANEL (Supplied By Others) TO
INCORPORATE QUICKDRAW HARNESSING

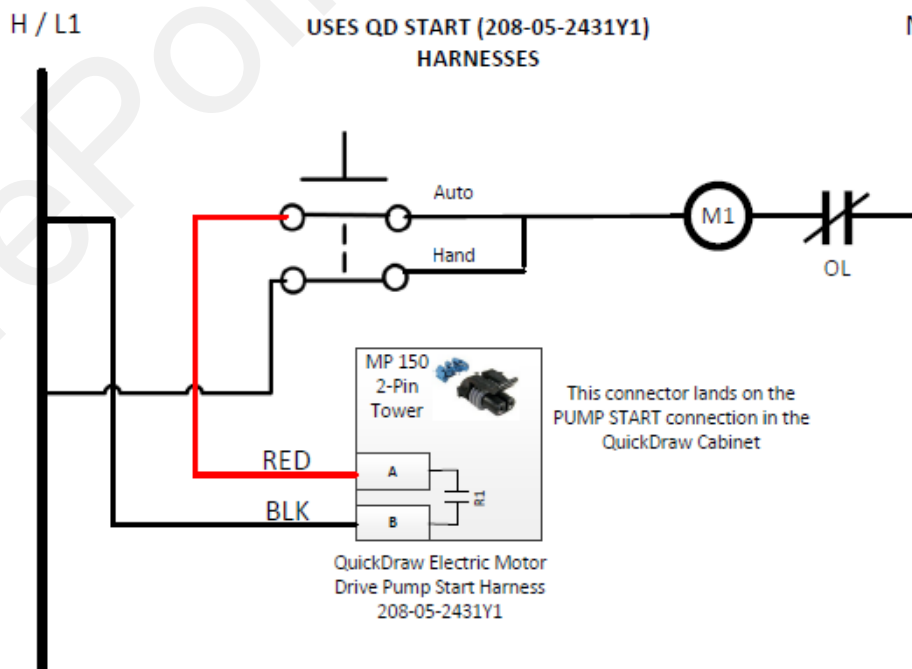



Hydraulic Pump Transfer Pump Harnessing

Hydraulic Pumps

- 208-05-3775Y1 - Hydraulic Transfer Pump & Agitation Harness
- 208-05-4240Y1 - Hydraulic Transfer Pump Hydraulic Solenoid Start Harness

Installation Instructions:

1. Use the 208-05-4240Y1 harness and plug into the **Pump Power** connector in the QuickDraw.
2. Next, plug the Pump Start connection into the **Pump Start** connector in the QuickDraw.
3. Plug the 2-pin connector into the 150MP connection on the solenoid coil. See next page for typical solenoid installation.
4. In the QuickDraw controller system settings, change the **Pump Start Mode** to MAINTAINED START. See Page 15.

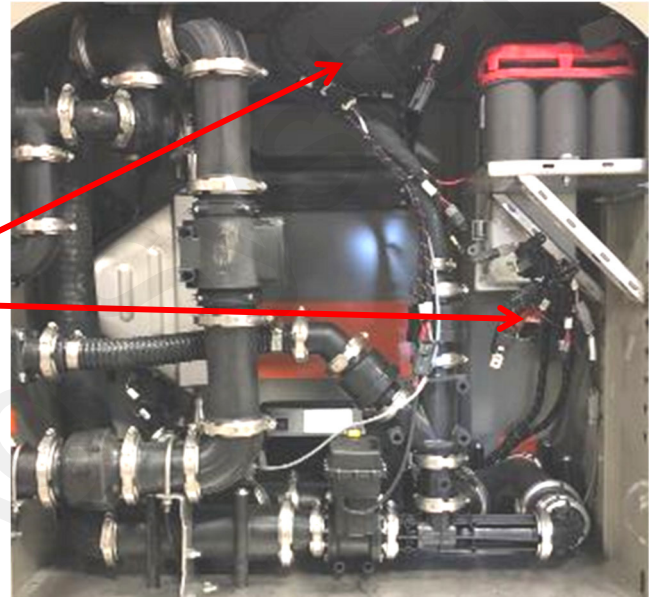

Step 1

Step 2

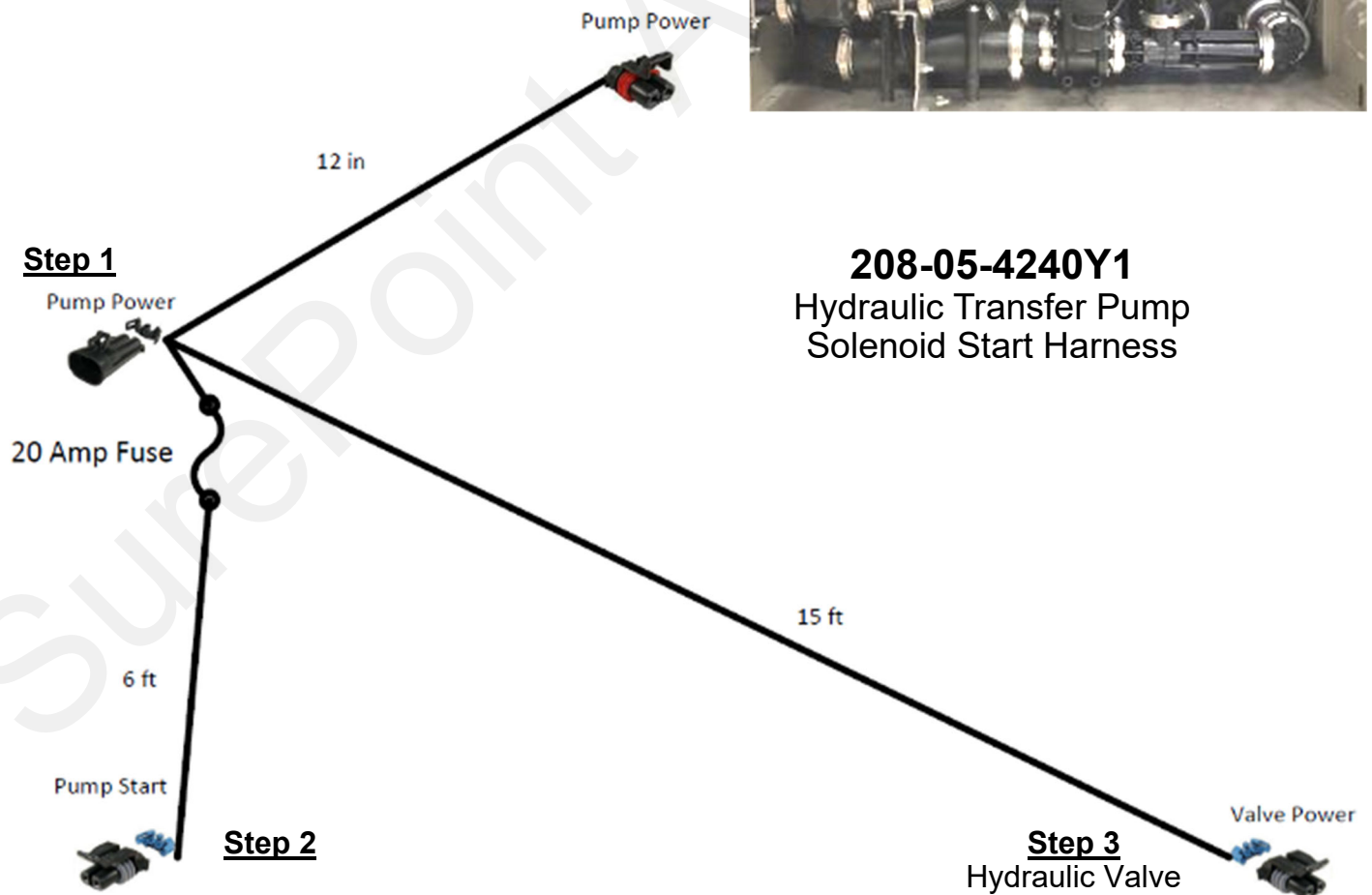



Hydraulic Pump Booster Pump Harnessing

This section is used for bulk products requiring more flow than is achievable by venturi suction.

Hydraulic Booster Pump Harnesses:

- 208-05-3774Y1 - Hydraulic Booster Pump Harness
- 208-05-3711Y2 - QuickDraw Aux Output Harness

Installation Instructions:

1. Plug 208-05-3711Y2 Aux Output Harness into the QuickDraw **Aux Outputs** connector.
2. Plug 208-05-3774Y1 Hydraulic Booster Pump Harness into the **Auxiliary Outputs** connector in the 208-05-3711Y2 harness
3. Plug the 2-pin connector into the 150MP connection on the solenoid coil. See next page for typical solenoid installation.
4. Setup QuickDraw controller for Boost pump operation and select which product valve the boost pump is connected to. See Page 15.

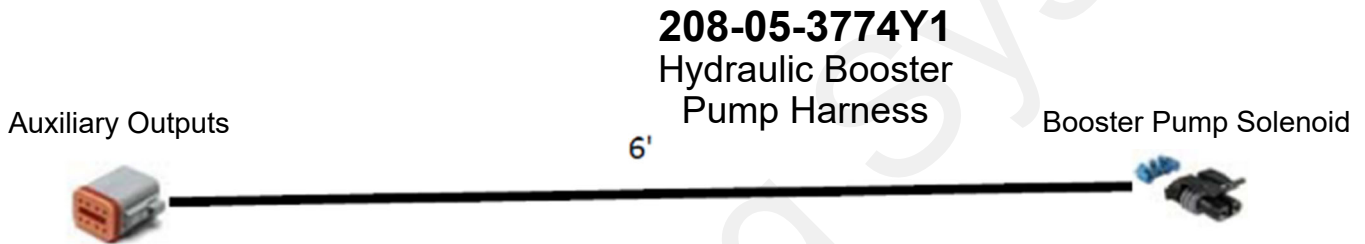

208-05-3711Y2 QuickDraw Aux Output Harness

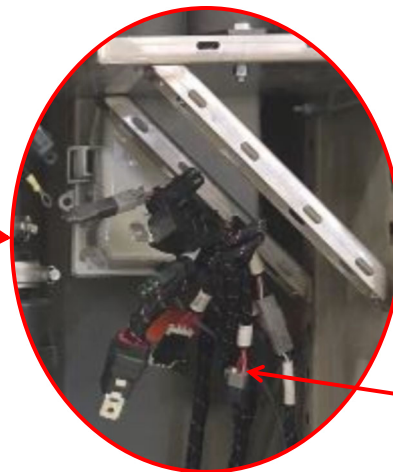
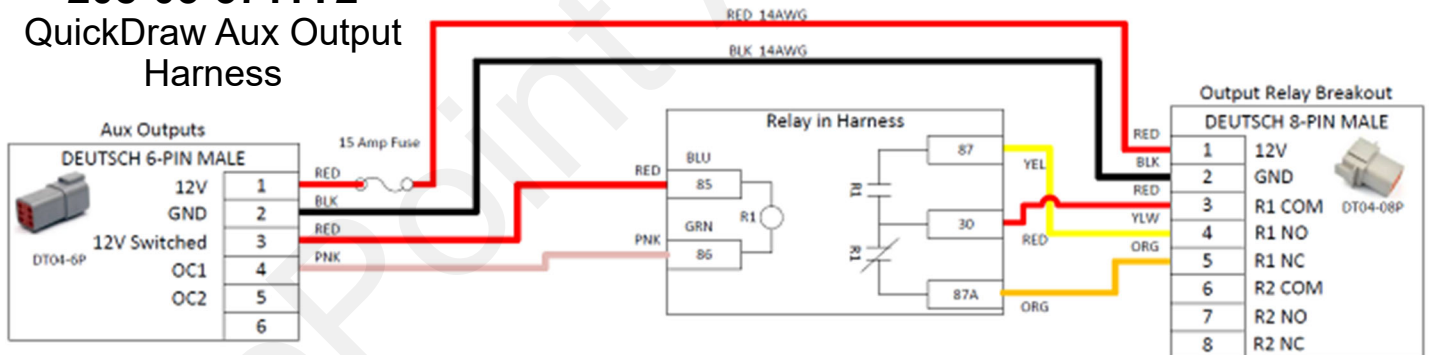

AUX Out
Connector



Hydraulic Pump Typical Hydraulic Solenoid Valve Detail



P/N: **206-02-13200**
2-pin 150MP - 5'
Extension Cable
(Qty 2 for Agitation and
Boost Pump Hydraulic
Solenoids)

P/N: **166-SV10-20M-0-N-00**
On / Off Solenoid Cartridge
Valve - Normally closed

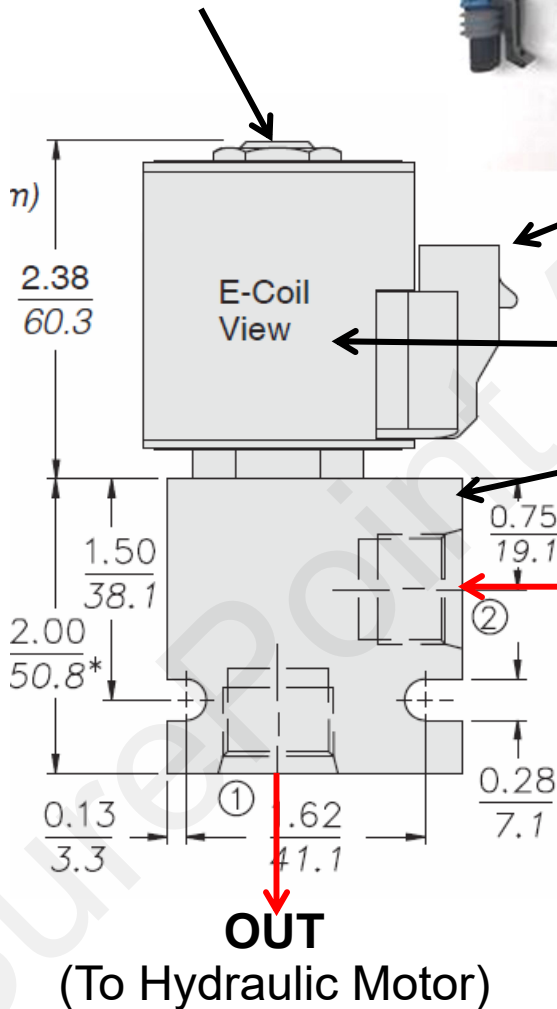

2-Pin 150 MP connection for 12V operation
of Hydraulic Solenoid on/off valve from
QuickDraw.

P/N: **166-4303512**
Coil, 12 Volt DC EY Coil

P/N: **166-7024280**
Hydraulic Valve Housing, Basic
2 Port Line Body

IN
(Hydraulic Pressure)

OUT
(To Hydraulic Motor)



Controller Setup for Pumps

Manual Pump Start/Stop:

The Manual Controls Screen allows the user to start/kill the transfer pump or start/kill the boost pump when outside of running a batch.

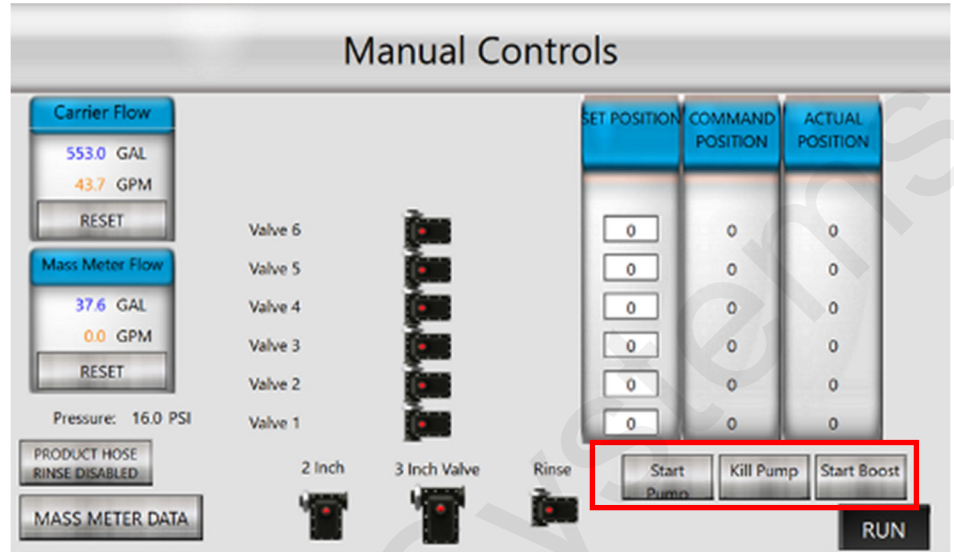

Pump Start Mode:

Momentary - The output is enabled for 3 seconds when the batch start is pressed

Maintained - The output is constant for the duration of the batch

For Hydraulic pumps, the pump start mode should be set to **Maintained Start**. For electric motors, depending on the electrical wiring and customer provided motor control center, either option may be selected. When using a start-stop push-button setup, **Momentary Start** should be selected.

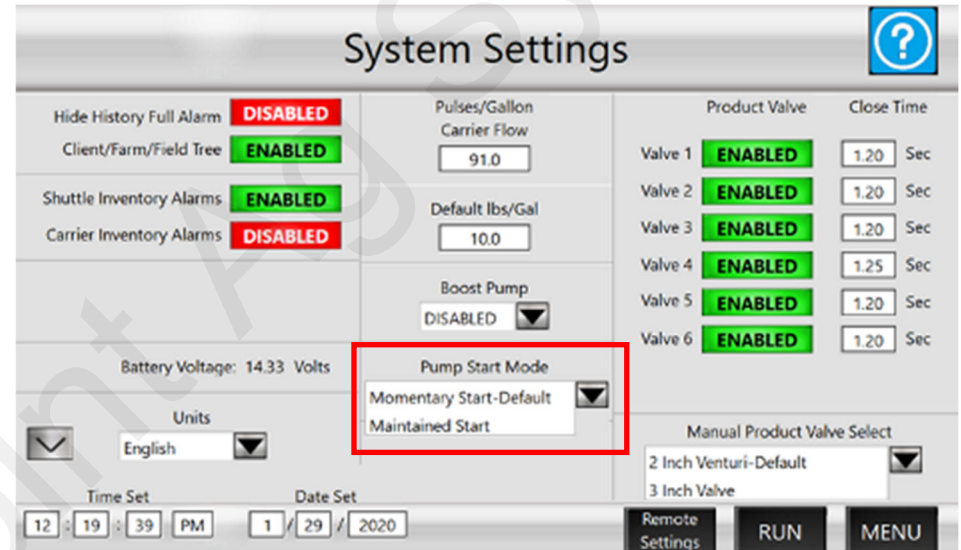

Boost Pump:

Choose **DISABLED** if no boost pump is present, or select the product valve the boost pump is connected to. Typically the 2" full ported Valve 1 is best for boost pump applications.

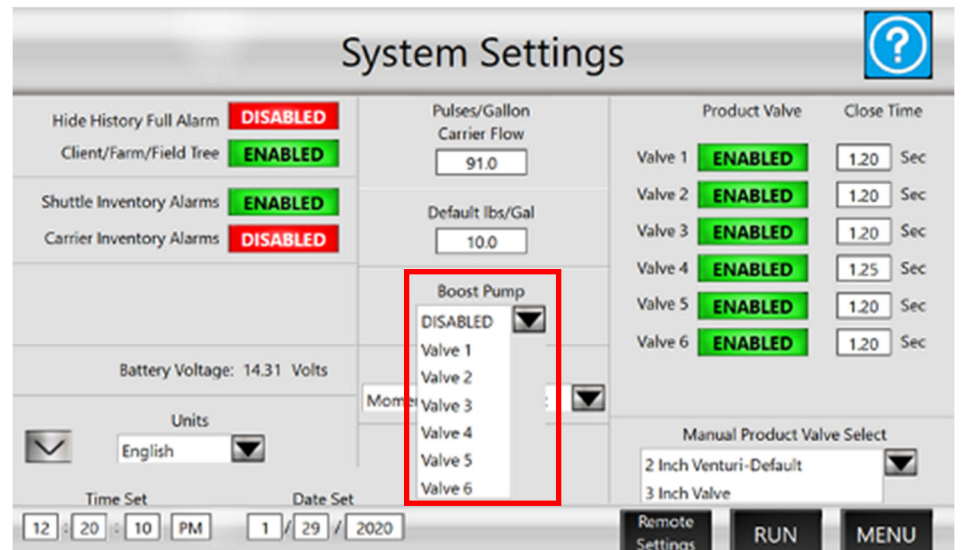



Remote Connectivity

Typically, Remote Connectivity is installed at the time of order by SurePoint Ag Systems. However, in some cases it may need to be installed in the field.

606-05-300150 - QuickDraw Remote Connectivity Kit

Installation Instructions:

1. Remove 3/4" pipe plug and gray PVC hole plugs. The existing Power Conditioner will need to be temporarily removed and relocated.
2. Install 3/4" cable gland and (2) SMA coax cable bulkheads (P/N: 217-3353Y1) into the pre-drilled and plugged holes.
3. Remove the existing 5" DIN rail and install the 4095Y1 mounting plate with (4) screws. Use 2" DIN rail and DIN rail stop to relocate the Mass Meter Power conditioner.
4. Install the QuickDraw modem using (2) Size 10 - 32 thread machine screws into the tapped mounting holes as shown.
5. Push the ethernet and power cable through the 3/4" cable gland and plug in.
6. Connect the ethernet cable to the bottom right M12 ethernet port on the QuickDraw controller.
7. Route the power cable to the **Modem Power** connector (under the battery tray) for 12VDC.
8. Remove the plug and install the GPS/Modem in the hole in the top of the cabinet. Connect the cable labeled GPS to the GPS SMA cable and one of the LTE (yellow label) antenn cables to the SMA cable. Make sure these correspond to the right connector inside the plastic enclosure.

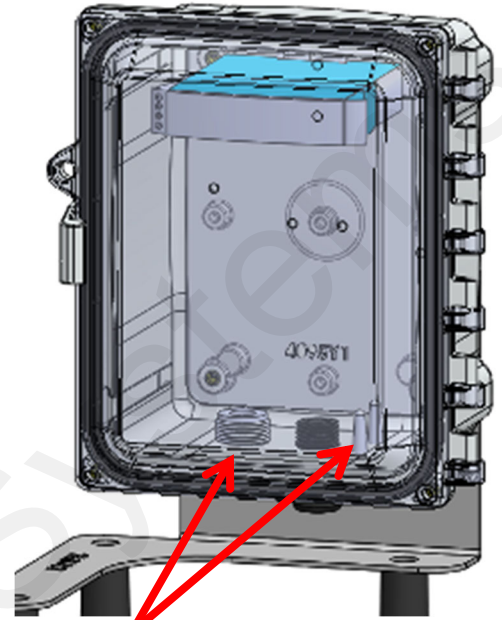

Step 1

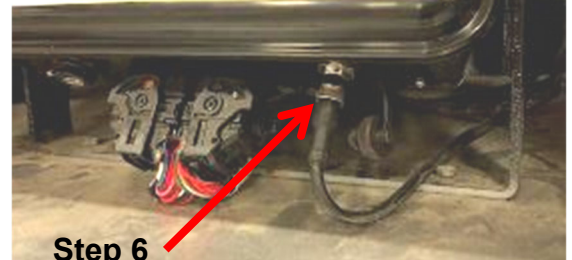

Step 6

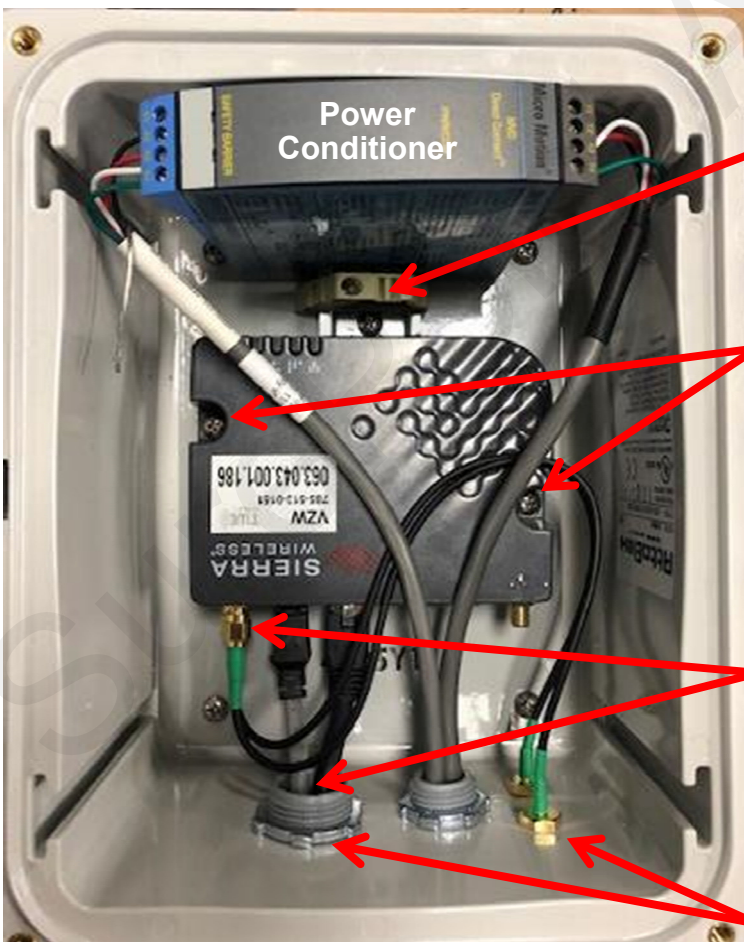

Step 3

Step 4

Step 5

Step 2



Step 8



Multiple Carrier Valve Wiring

QuickDraw 3000 has the functionality for up to 4 carrier products. During a batch the QuickDraw can switch between the different carriers by opening and closing CAN controlled valves.

Multiple Carrier Connection

- 103-3366Y1 - 3" CAN Valve or 103-2102Y1 - 2" CAN Valve
- 208-05-3363Y2 - CAN Valve Expansion Harness
- 208-05-3390Y1 - CAN Y Adapter
- 206-04-29__Y1 - 4-Pin Deutsch Extension Cable
 - 5 ft - 206-04-2913Y1
 - 10 ft - 206-04-2914Y1
 - 20 ft - 206-04-2915Y1
 - 30 ft - 206-04-2996Y1
 - 40 ft - 206-04-2997Y1
 - 50 ft - 206-04-2998Y1

Installation Instructions:

Before plugging in any valves, you'll need to enable Multiple Carrier in the QuickDraw controller. See the next page for setup and addressing the valves.

1. Layout plumbing system and install CAN valve(s).*
2. Remove the CAN Bus terminator (P/N 208-06-2912Y1) from the end of the QuickDraw harness connection labeled **Bus Extension/Termination**. This part may need to be re-used.
3. **1st Option:** If the CAN Valves are located close to each other, use the appropriate length extension harness and plug into the **Bus Extension/Termination** connector in the QuickDraw, then plug the 208-05-3363Y2 QuickDraw CAN Valve Expansion Harness to the end of the extension.

* Use Y fittings for optimal flow efficiency on the inlet side of a transfer pump. For better manifold cleanout, it is also recommended to have the end (straight) valve connected to clean water.

1st Option:

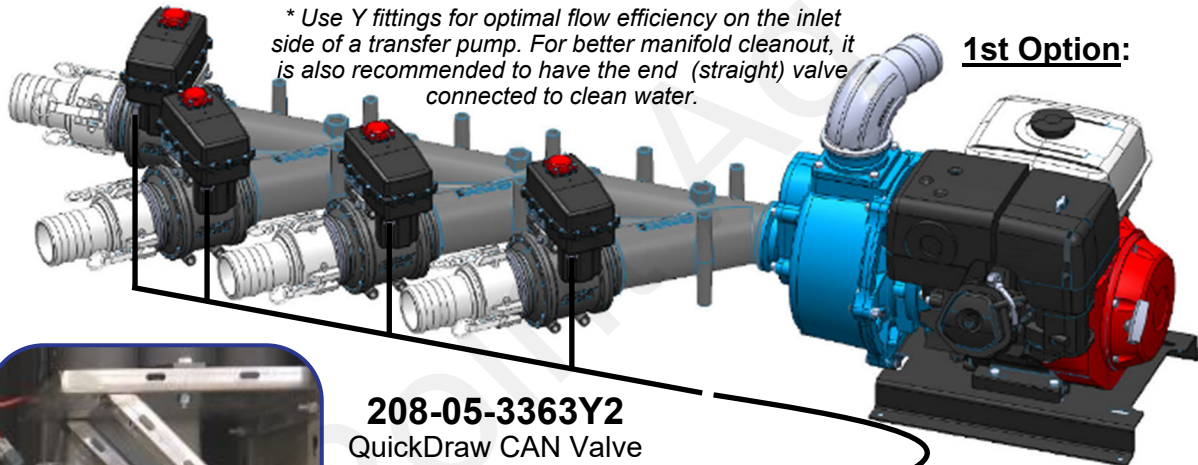

208-05-3363Y2
QuickDraw CAN Valve
Expansion Harness

206-04-29__Y1
4-Pin Deutsch Extension Cable



Step 2

2nd Option:

CAN Valve
Connection

208-06-2912Y1
CAN Bus Terminator

Connect to
Extension Cable

208-05-3390Y1
CAN Y Adapter



3. **2nd Option:** If CAN Valves are not in close proximity, use the appropriate length extension harness to route from the **Bus Extension/Termination** connector in the QuickDraw to the closest CAN Valve. Use CAN Y Adapter (208-05-3390Y1) to connect to the valve and extension cable to the next valve. Repeat until all valves are connected, re-use CAN bus terminator harness (208-06-2912Y1) at the final Y adapter.
4. Plug in the CAN valves in desired order, one at a time, so they are properly addressed within the QuickDraw controller. Valve order can also be reset, see next page.



Multiple Carrier Initial Setup

Setup Instructions:

1. Go to the menu, select Settings.
2. Press the area just left of the Battery Voltage. Hit Enter on the keyboard that pops up.
3. Select the appropriate number of Carriers (1-4). Press Menu. This will flash a CAN Bus error because the valves are not addressed.
4. Plug in the 3" CAN valves in desired order, one at a time, so they are properly addressed within the QuickDraw controller.
5. If the numerical order of the valves needs to be changed, use the Reset Address Carrier buttons on the Maintenance screen to readdress the valves to the desired order.

The screenshot displays three screens from the SurePoint Ag Systems control interface:

- System Settings:** Shows various system parameters. A red hexagon highlights the "PRESS HERE" button next to the "Battery Voltage: 14.33 Volts" display. Other settings include "Hide History Full Alarm" (DISABLED), "Client/Farm/Field Tree" (ENABLED), "Shuttle Inventory Alarms" (ENABLED), "Carrier Inventory Alarms" (DISABLED), "Pulses/Gallon Carrier Flow" (91.0), "Default lbs/Gal" (10.0), "Boost Pump" (DISABLED), "Pump Start Mode" (Momentary Start-Default), "Manual Product Valve Select" (3 Inch Valve), and "Time Set" (12:19:39 PM, 1/29/2020).
- MISCELLANEOUS:** Shows configuration options for "Carrier Meter Select" (ARAG), "Pressure Input" (AI[4] QD3), "Reset to Factory Defaults" (RESET), "Load Default File" (Load), "Number of Carriers" (1, 2, 3, 4), "Email vs Website" (il History), "Select Suction vs Non-Suction" (Non-Suction), and "Select 4 Product vs 6 Product" (6 Product). A red arrow points to the "Number of Carriers" dropdown menu.
- MAINTENANCE:** Shows "Model Code" (400-1.8-6-910), "Software Rev. 2.2.6", "Display Rev. 1.8", and "RESET ALL ADDRESSES" button. A red box highlights the "RESET ADDR CARRIER 1" through "RESET ADDR CARRIER 4" buttons. A note states: "Note: Pressing the RESET buttons will erase the current valve address." A photograph of the physical valve assembly is also shown.

Hose Reel Power Connection & Wiring

Hose Reel Harnesses

- 208-NAPA7578 - 12 Volt Battery, BCI Group 78 (Or customer provided)
- 205-2201Y1 - 40 Amp Y Cable (480 MP shroud x 2 480 MP tower's)
- 205-2213Y1 - 40 Amp 480MP Power Cable - 20' 6AWG

QuickDraw Power Connections (From Power Connection Section on page 5):

- Connect the ring terminals of the 205-2213Y1 harness to the truck/tractor battery and route to the hitch or disconnection point. (May have already been completed)
- Use the appropriate length or combination of 2-pin 480MP extension cables to route from the trailer hitch to inside the QuickDraw.
- Connect the extension harness to the connector labeled **External Power**.

Hose Reel Power Connections:

1. Provide battery cover and securely mount 12V dedicated hose reel battery. Connect the ring terminals of the 205-2213Y1 harness to the battery and route harness inside the QuickDraw Cabinet.
2. Connect 201-4241Y1 (40A 480MP Tower x 2 480MP Shroud Y Cable) to the connector labeled **External Power** inside the QuickDraw.
3. From the 201-4241Y1 (40A 480MP Tower x 2 480MP Shroud Y Cable), connect 206-02-220_Y1 (extension cable, length varies) from truck/tractor battery power supply harness and 205-2213Y1 (Fused Power Cable) from hose reel terminals.

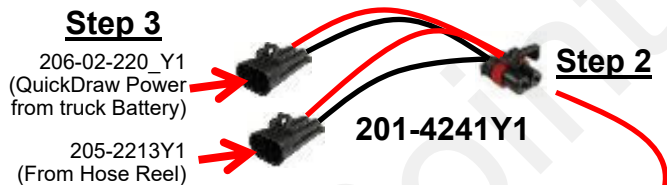

Step 1





Electric Carrier Fill Valve Control Trailer Layout and Wiring

Custom Trailer Harness

- 606-04-100400 - QuickDraw Trailer 3" Electric Valve Upgrade - 2 Carrier Tanks
 - 208-05-4193Y1 - Electric Carrier Fill Valve Control Harness
 - (2) 103-2417Y1 - 3" Manifold Electric Valve
- 606-04-100500 - QuickDraw Trailer 3" Electric Valve Upgrade - Single Carrier Tank
 - 208-05-4193Y1 - Electric Carrier Fill Valve Control Harness
 - (2) 103-2417Y1 - 3" Manifold Electric Valve

Installation Instructions:

1. Route harness on trailer as shown and plug 3-pin connectors into the 3" valves. *Note: For single carrier tank installations, the rear valve won't be used.*
2. Connect the 2-Pin 480MP tower connector to **Pump Power** in the QuickDraw. *Note: The harness is designed to extend the pump power connector for wiring the pump start/stop.*
3. Remove 1/4" bolt for Product Valve label and install 475-4266Y1-SS - QuickDraw Aux Switch mounting bracket. Mount valve switches in the mounting bracket.

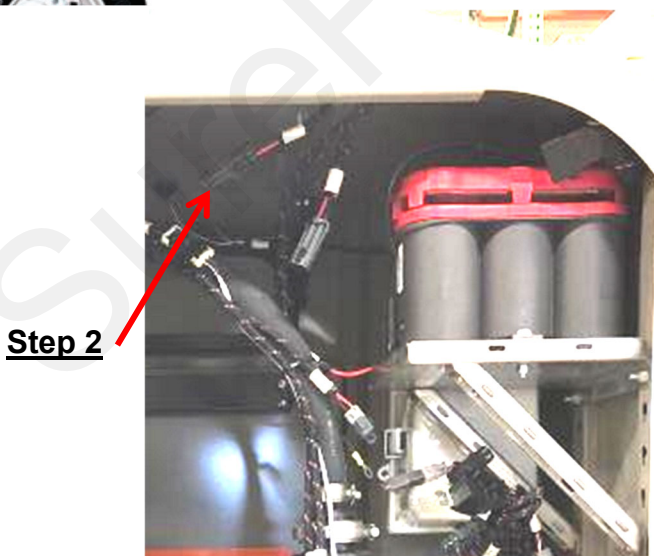
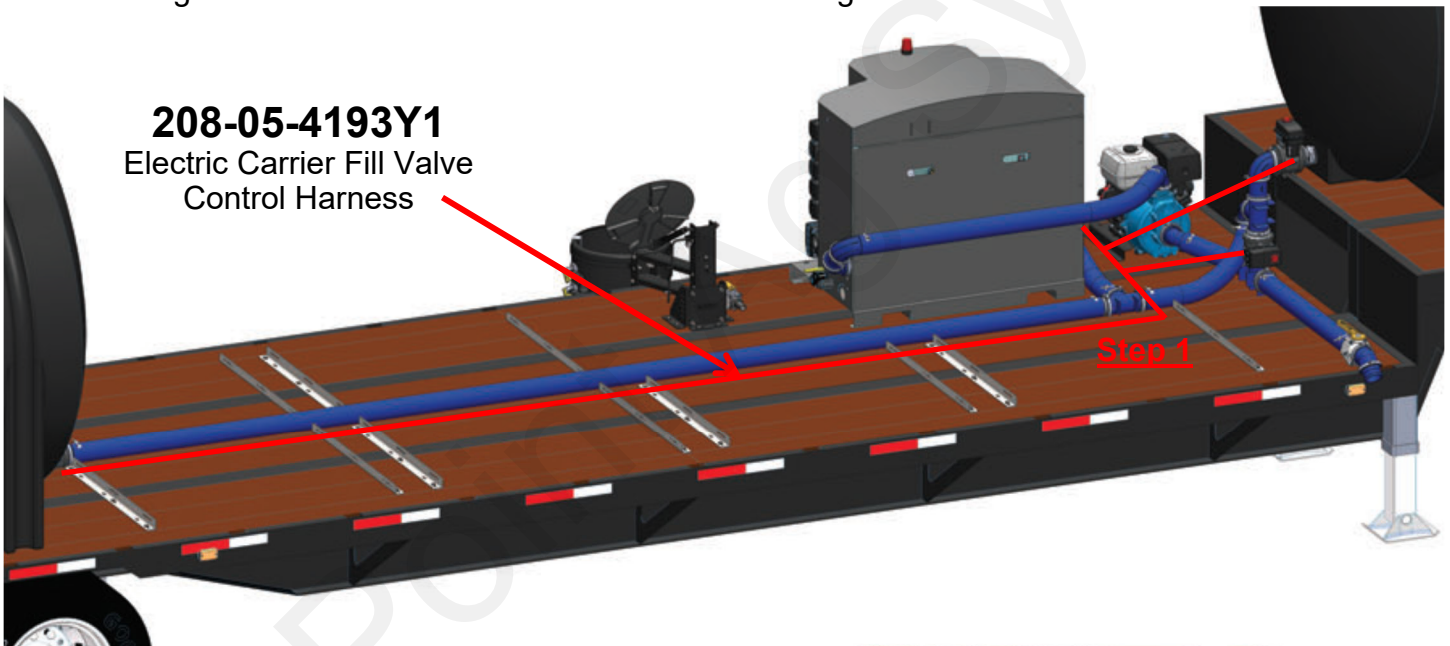

Step 3





3000

SurePoint FPS Systems