

396-3612Y1



Fertigation and Chemigation Injection Manual

AC Variable Frequency
Driven Pump



SureFire
Ag Systems



Table Of Contents

Introduction

- Safety
- Warranty Policy
- Marksman System Example Layout

Components - Liquid

- Common Parts List
- Pump Parts List
- Marksman Plumbing Accessories

Components - Wiring & Electrical

- VFD Control Box 480 VAC 3-Phase
- VFD Control Box 120 VAC
- Marksman Wiring Harness Schematic
- Marksman Harness Accessories

Controller Setup & Operation

- Controller Keys and Menu Structure
- Front Screen and Main Menus
- Advanced Menus
- Marksman Website

Troubleshooting

- Marksman Error Messages

Maintenance & Parts

- Winterization

A

B

Components
Liquid

D

Components
Wiring & Elec.

F

Setup &
Operation

G

Trouble-
Shooting

H

Maintenance



Safety

A

TAKE NOTE! THIS SAFETY ALERT SYMBOL FOUND THROUGHOUT THIS MANUAL IS USED TO CALL YOUR ATTENTION TO INSTRUCTIONS INVOLVING YOUR PERSONAL SAFETY AND THE SAFETY OF OTHERS. FAILURE TO FOLLOW THESE INSTRUCTIONS CAN RESULT IN INJURY OR DEATH.



**THIS SYMBOL MEANS
ATTENTION!
BECOME ALERT!
YOUR SAFETY IS INVOLVED!**

Note the use of the signal words **DANGER**, **WARNING** and **CAUTION** with the safety messages. The appropriate signal word for each has been selected using the following guidelines:



DANGER: Indicates an imminently hazardous situation that, if not avoided, will result in death or serious injury. This signal word is to be limited to the most extreme situations typically for machine components which, for functional purposes, cannot be guarded.



WARNING: Indicates a potentially hazardous situation that, if not avoided, could result in death or serious injury, and includes hazards that are exposed when guards are removed. It may also be used to alert against unsafe practices.



CAUTION: Indicates a potentially hazardous situation that, if not avoided, may result in minor or moderate injury. It may also be used to alert against unsafe practices.

NOTICE is used to address safety practices not related to personal safety.



Warranty Policy

A

SureFire Ag Systems, Inc. (hereinafter referred to as "SureFire") warrants the whole goods products it sells to be free from defects in material or workmanship for a period of one (1) year from the date of sale of the product(s) to the original user.

SureFire warrants the parts it sells to be free from defects in material or workmanship for a period of ninety (90) days from the date of delivery of the product(s) to the original user. This shall include replacement parts installed by SureFire.

Warranty of SureFire whole goods and/or parts applies only to material and workmanship. Misuse, misapplication, neglect, alteration, accident, normal wear, or acts of God affecting SureFire products are not eligible for warranty. Warranty shall apply only to the smallest reasonably serviced component (e.g. if a PWM solenoid fails on a hydraulic pump assembly, only the solenoid will be covered under warranty, not the entire pump assembly). In the event that multiple components are replaced, component warranty eligibility will be assessed once the parts are returned to SureFire for determination of failure (parts determined to still be in working order will be returned to the dealer and warranty will not apply to those components).

WARRANTY CLAIMS: A warranty claim and request to return defective product(s) must be presented to the SureFire Service Department, describing the defect in material or workmanship of the product(s). This claim may be made via phone, e-mail, fax, or written request. Claims for warranty of whole goods or parts must also include proof of date of sale of the product(s) to the original user.

The SureFire Service Department will proceed in making a preliminary decision as to the eligibility of the claim for warranty consideration. After the SureFire Service Department deems it necessary to proceed with warranty consideration, a determination will be made as to whether or not the original product needs to be returned to SureFire. In the event a return is deemed necessary, a Return Materials Authorization (RMA) will be generated by the SureFire Service Department. The defective product(s) in question must be sent, freight prepaid, within fourteen (14) days of the discovery of the product failure and initial warranty claim. Replacement product(s) may be sent to the selling dealer, directly to the customer, or picked up at the SureFire facility. At the discretion of the SureFire Service Department, replacement product(s) may be sent prior to, or after, the SureFire Returns Department receives the defective product(s).

Any variation in the above procedure is at the sole discretion of the SureFire Service Department.

SureFire agrees to handle all warranty claims in a timely manner and will inform dealers of any revisions or modifications to the SureFire Warranty Policy. Eligible warranty claims will be processed by SureFire within sixty (60) days of receiving failed product(s).

If a warranty claim is found to be ineligible for warranty coverage, the SureFire Service Department will be responsible to inform the dealer or end user in order to determine the course of action to be taken. SureFire reserves the right to make changes in specification and design without notice and without incurring any obligations to owners of products previously sold.



Typical Center Pivot Marksman Setup

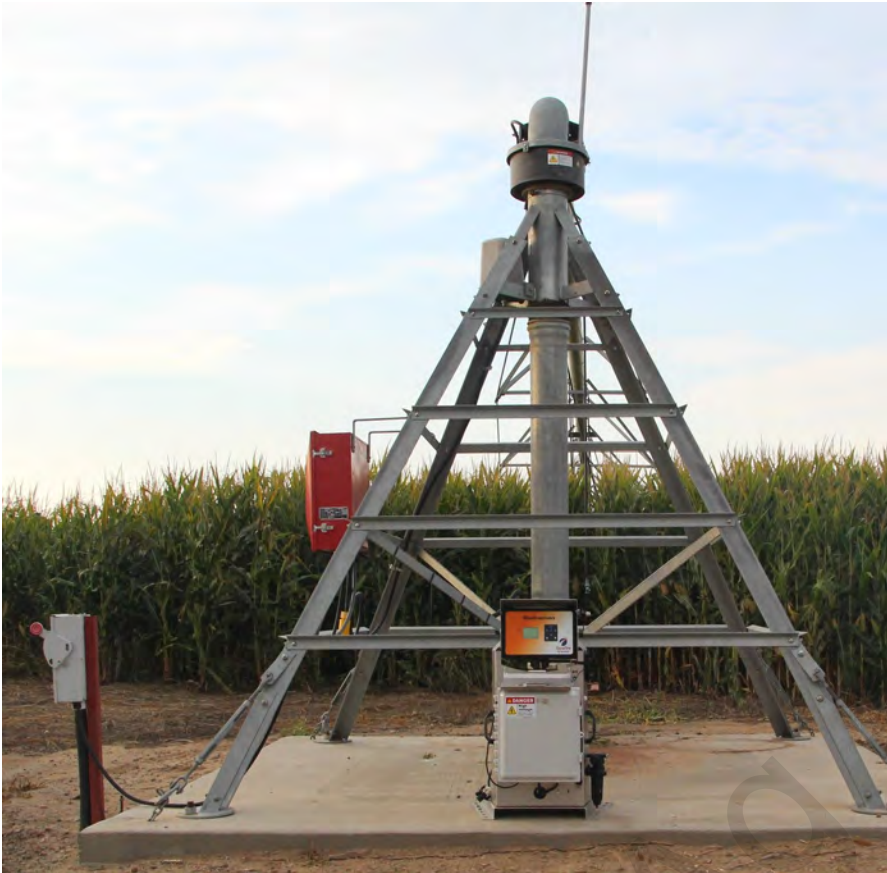
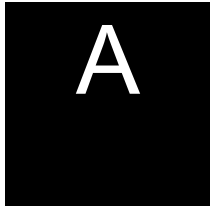

This picture shows Marksman setup at the pivot point. It is powered by 480 VAC from the center pivot control panel mounted directly to the pivot structure.

Marksman can easily be installed at the well location if that is preferred in your irrigation system.

Many customers also mount the Marksman on a trailer with a tank. To operate, pull the trailer up to the injection location, hook up power and the injection hose and start the Marksman.

A water pressure sensor can be installed with any Marksman. Here is it mounted in a tee that also has a pressure gauge. In this case, the water pressure sensor is used to shut down the Marksman if irrigation water pressure is lost.



The Marksman output hose is attached to the injection quill mounted in the irrigation system water one way valve assembly. A bleeder valve is mounted with the injection quill to let air out of the system.



Parts List

Controller & Common Plumbing

B

Components

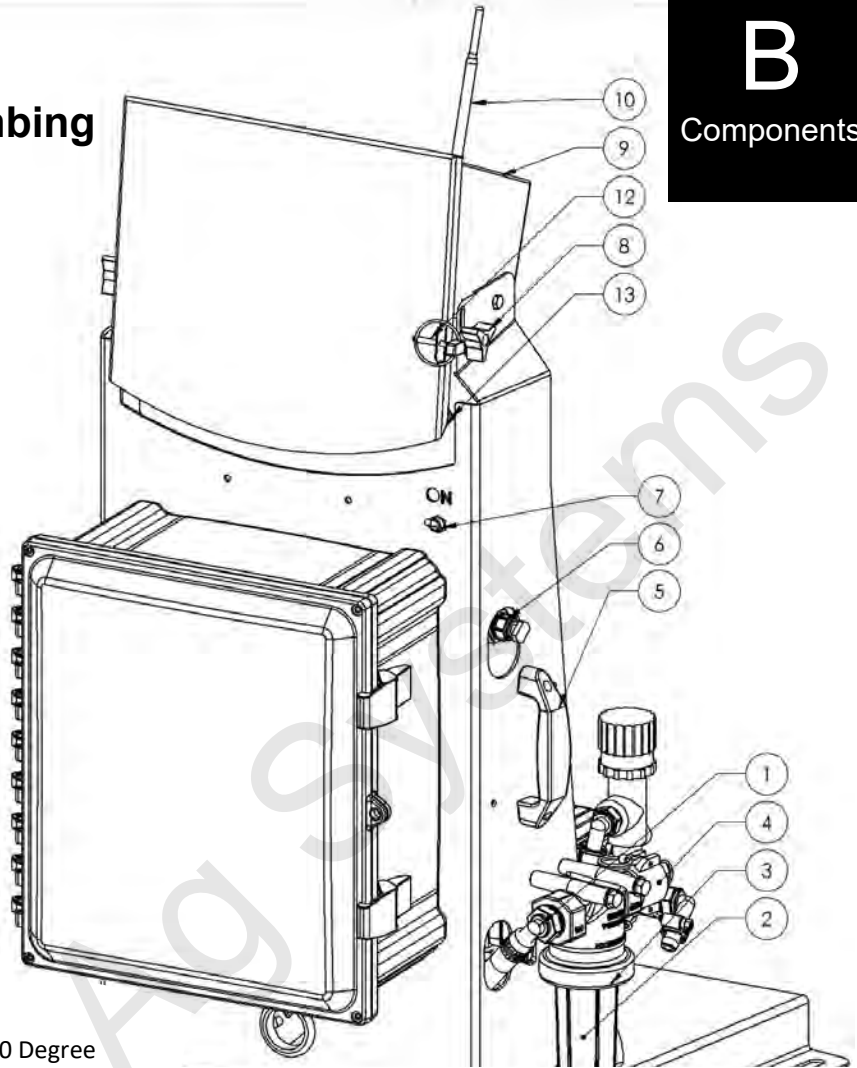
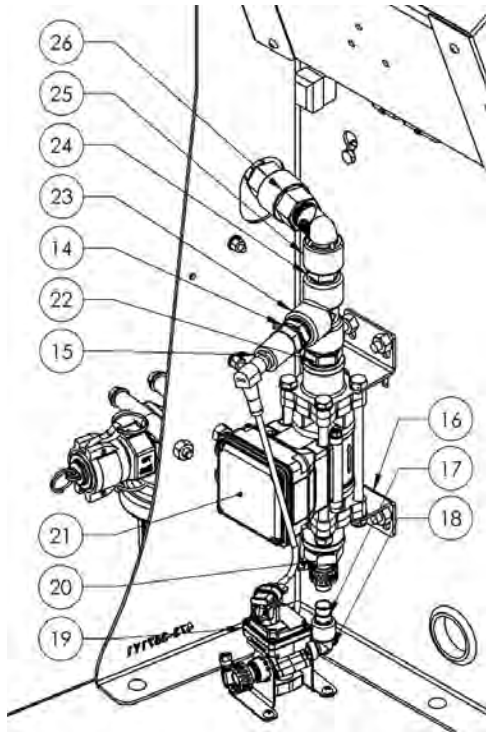

Item	Part Number	Description
1	101-075050-90	3/4" MPT x 1/2" HB - 90 Degree
2	110-LST150	LST 50 Mesh Screen (other size screens available)
3	109-075LST-50V	3/4" Viton Tee Strainer - 50 Mesh
4	106-075B	3/4" Female Coupler x 3/4" MPT
5	399-1950A3	Black Handle with Gray Dots
6	113-06-038050-P	QC to MPT - 3/8" QC x 1/2" MPT - polypropylene
7	217-3466Y1	Sealed Toggle Switch for Outdoor Mounting with 2 Pin MP150 Shroud Connector
8	757-57715K29	Controller Mounting Knob (1/4" thread bolt)
9	473-3823Y1-SS	Marksman Hinged Controller Shield
10a	217-3650Y1	Antenna (Round, 3/8" diameter, 7" Length)
10b	217-3916Y1	LTE Broadband Dipole Antenna (Flat, 1 1/8" wide, 8" Length) - qty 2 required, 1 top, 1 bottom
11	217-3761Y1	GPS Antenna
12	355-030109-WC	Lynch Pin - 3/16" x 1 - 9/16" with chain
13	224-3561Y1	Marksman Controller Assembly With Modem (224-3560Y1—No Modem)
14	100-050025RB	1/2" MPT x 1/4" FPT Reducer Bushing
15	521-05-050400	400 PSI 3 wire pressure sensor (0 - 5 V DC) with 3 pin 150 MP Tower connector
16	400-3826Y1-SS	SS Flowmeter Mounting Bracket
17	113-01-038050	Stem to HB - 3/8" Stem x 1/2" HB
18	113-12-038038-P	Stem Elbow - 3/8" Stem x 3/8" QC - polypropylene
19	103-3250Y1	Zip Valve 1/4" Nylon, 2-way, stainless steel ball, Deutsch Connector
20	101-075050-H	3/4" MPT x 1/2" HB
21	204-01-46211CUF00	Electro Magnetic Flow meter 0.13 - 2.6 GPM
22	100-075050RN	3/4" x 1/2" Reducer Nipple
23	100-050TEE	1/2" Pipe Tee
24	100-050NIP-SH	1/2" Short Nipple
25	100-050050SL-90	1/2" Street Elbow - 90 Degree
26	136-5492K999	1/2" Polypropylene Check Valve with Viton Seals and Stainless Steel spring

Parts List

Hydra-Cell 3 Piston Pump & Plumbing

B

Components

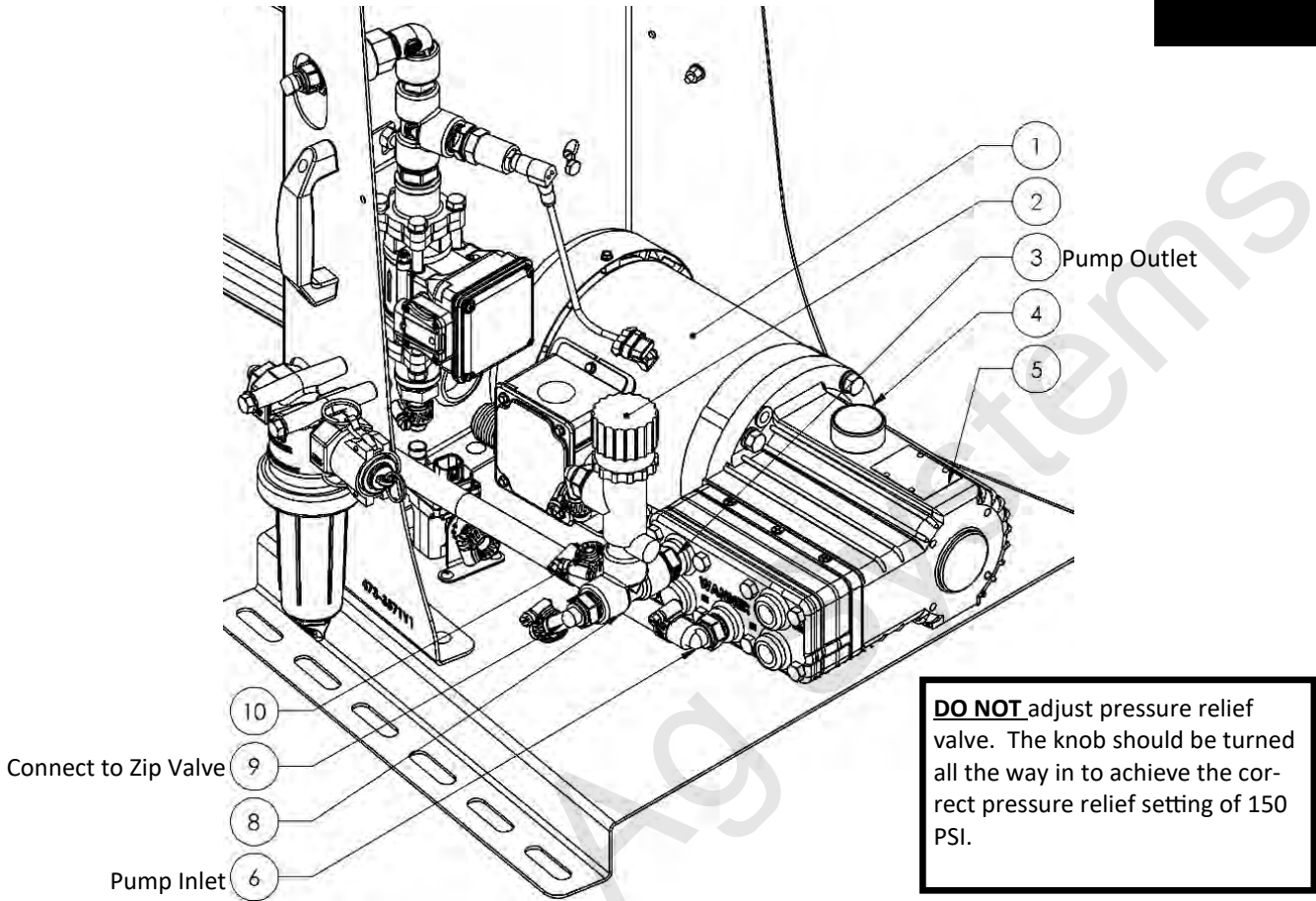

Item	Part Number	Description
1	210-3569Y1	Electric Motor, 1/2 HP, 1800, 10:1, 56C, 230/460 volt 3-phase
2	102-23120A-1/2-PP	1/2" Pressure Relief/Regulating valve w/ pressure port - 150 PSI (316SS Spring & Viton O-ring)
3	100-050038RN	PUMP OUTLET FITTING 1/2" x 3/8" Reducer Nipple
4	291-12-D03-039-1030	Oil Breather Cap
5a	290-04-3568Y1	HydraCell Pump - 3 GPM (M03XKPGSNEPA)
5b	290-04-3718Y1	HydraCell Pump - 1 GPM (M03BAPGSNEPA)
6	101-050050-90	PUMP INLET FITTING 1/2" MPT x 1/2" HB - 90 Degree
8	100-050TEE	1/2" Pipe Tee
9	101-050050-90	1/2" MPT x 1/2" HB - 90 Degree
10	101-050050050-HB	1/2" x 1/2" x 1/2" HB Tee (connects pressure relief into pump inlet hose)
11	101-050050-90	1/2" MPT x 1/2" HB - 90 Degree

Marksman Hydra-Cell 3 GPM Pump Specifications	
Minimum Flow:	15 GPH
Maximum Flow:	180 GPH
Maximum Operating Pressure:	125 PSI
Pressure Relief Pressure:	150 PSI

Marksman Hydra-Cell 1 GPM Pump Specifications	
Minimum Flow:	6 GPH
Maximum Flow:	60 GPH
Maximum Operating Pressure:	125 PSI
Pressure Relief Pressure:	150 PSI

Parts List

Acid Resistant Model

B

Components

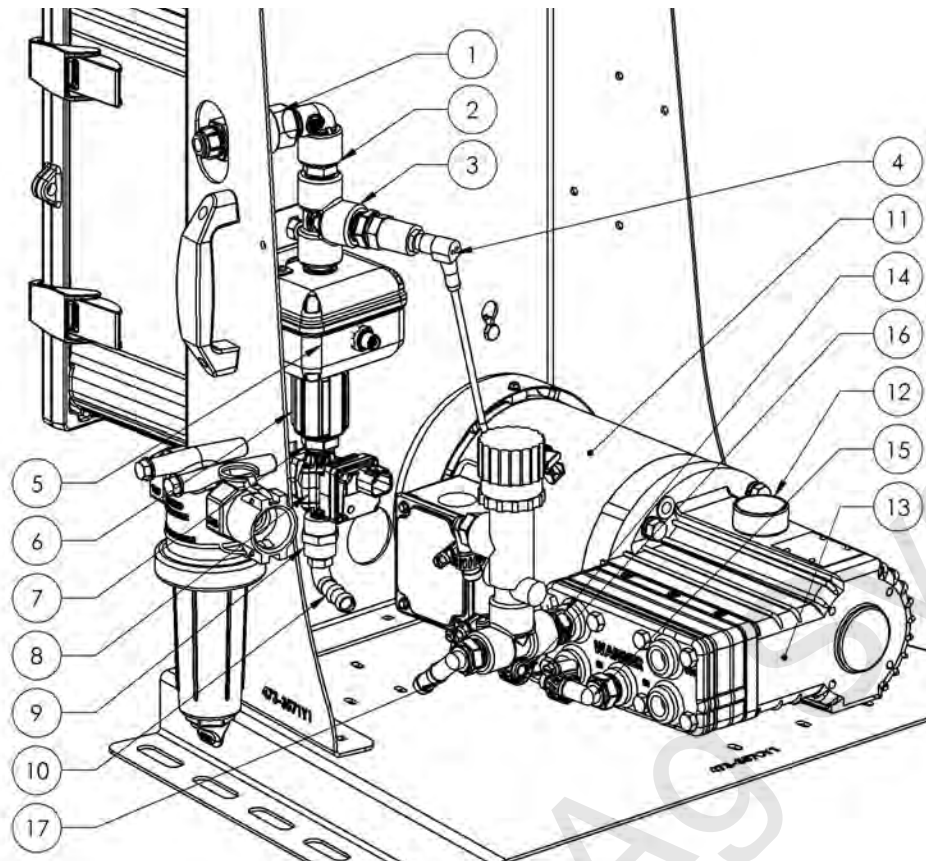

DO NOT adjust pressure relief valve. The knob should be turned all the way in to achieve the correct pressure relief setting of 150 PSI.

Item	Part Number	Description
1	136-5492K999	1/2" Polypropylene Check Valve with Viton Seals and Stainless Steel spring
2	100-050NIP-SH	1/2" Short Nipple
3	100-050TEE	1/2" Pipe Tee
4	521-05-050400	400 PSI 3 wire pressure sensor (0 - 5 V DC) with 3 pin 150 MP Tower connector
5	204-01-PE202	Seametrics PE202-038 Kynar Body Flowmeter (.03 - 3GPM)
6	100-050CPLG	1/2" Pipe Coupling
7	100-050025RB	1/2" MPT x 1/4" FPT Reducer Bushing
8	103-3841Y1	Zip Valve 1/4" MPT Kynar, 2-Way, Stainless Steel Ball, Deutsch Connector
9	100-025CPLG-A	1/4" Pipe Coupling
10	101-025050-90	1/4" MPT x 1/2" HB - 90 Degree
11	210-3569Y1	Electric Motor, 1/2 HP, 1800, 10:1, 56C, 230/460 volt 3-phase
12	291-12-D03-039-1030	Oil Breather Cap
13a	290-04-3568Y1	HydraCell Pump - 3 GPM (M03XKPGSNEPA)
13b	290-04-3718Y1	HydraCell Pump - 1 GPM (M03BAPGSNEPA)
14	100-050038RN	PUMP OUTLET FITTING 1/2" x 3/8" Reducer Nipple
15	101-050050-90	PUMP INLET FITTING 1/2" MPT x 1/2" HB - 90 Degree
16	101-050050050-HB	1/2" x 1/2" x 1/2" HB Tee (connects pressure relief into pump inlet hose)
17	101-050050-90	1/2" MPT x 1/2" HB - 90 Degree

Marksman Hydra-Cell 3 GPM Pump Specifications

Minimum Flow:	15 GPH
Maximum Flow:	180 GPH
Maximum Operating Pressure:	125 PSI
Pressure Relief Pressure:	150 PSI

Marksman Hydra-Cell 1 GPM Pump Specifications

Minimum Flow:	6 GPH
Maximum Flow:	60 GPH
Maximum Operating Pressure:	125 PSI
Pressure Relief Pressure:	150 PSI

Marksman Plumbing Accessory Items

B

Components

Marksman Inlet Plumbing Kit 546-05-100100



The inlet plumbing kit includes the items shown above along with hose clamps and thread sealer. It will attach connect a 2" male camlock to the marksman inlet (3/4" female cam lock on Marksman strainer). 3/4" hose maximum 20 feet long can be used for flows up to 180 GPH. Over this length and flow rate use a larger diameter inlet hose.

Marksman Outlet Plumbing Kit 546-05-100150



The Marksman outlet plumbing kit has a 3/8" stem fitting to connect to the Marksman outlet quick connect fitting. The kit contains 20' of 1/2" hose and either 3/8" stem or 1/2" MPT fitting to attach to your injection point.

The 3/8" stem x 1/2" hose barb fitting is also included with every Marksman to attach to an existing 1/2" hose.

What size Marksman outlet hose do I need?

There is no one size fits all answer to this question. However, the safe answer is a larger hose won't cause you any problems. **A 50 foot long 1/2" hose can be used at flow rates up to 180 GPH with a product no higher viscosity than 28% or 32% nitrogen.** This will have a pressure drop of 10 psi in the hose which is the maximum pressure drop SureFire recommends. If you are over this hose length, flow rate or viscosity use a larger hose; consult SureFire for recommendations.

3/8" tubing (1/4" ID) is a convenient choice and will work for lower flow rates. **A 15' foot length of 3/8" tubing can be used at flow rates up to 40 GPH with a product no thicker than 28% or 32% nitrogen.** If you are over that hose length, flow rate or viscosity use the 1/2" hose outlet plumbing kit above.

Marksman VFD Control Box

480 volt AC 3-phase input

D
Components
Wiring & Elec.



The Marksman uses a variable frequency drive (VFD) to control the speed of a pump with a 3 phase AC motor. The 480 volt 3 phase power in the VFD control enclosure will cause death or serious injury. Disconnect power before servicing.

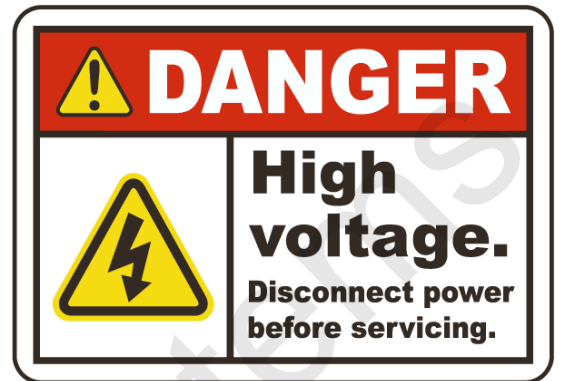

Power into VFD control box attaches to top of circuit breaker. This power will be on any time power supply is ON to Marksman, regardless of breaker switch position.

Relay provides signal for the VFD to turn output power on based on Marksman controller input.

Triple circuit breaker (4-amp) for 3 phase power. ON position is switches up (as shown) with red showing in the window under the switches.

Variable frequency drive (VFD) controls motor and pump speed based on 4-20 mA signal from Marksman. The variable frequency drive has a screen and input buttons. The VFD is setup by SureFire in the manufacturing process and should never require the operator to adjust settings in normal operation.

12 VDC Power Supply
Supplies power for Marksman controller from input 480 volt 3-phase AC power (voltage set to 14.0 volts)

12 VDC battery for backup power to send power loss messages and close product valve

Variable frequency drive line reactor to protect electrical system from electrical noise generated by VFD.

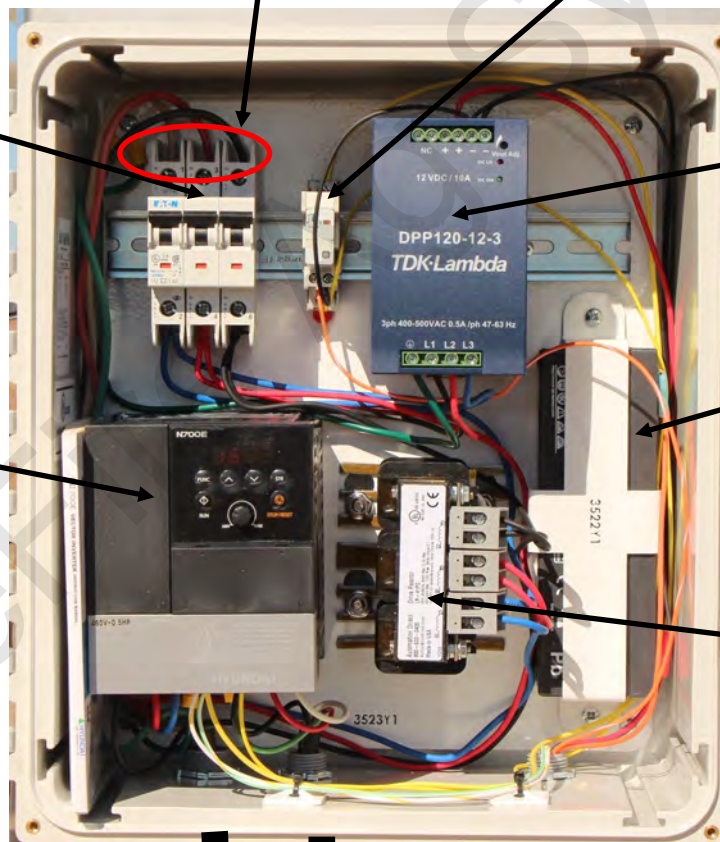

NEMA L16-30P plug for 480 VAC 3-phase input power

480 VAC 3-phase connected directly to motor



6-pin Deutsch connector to Marksman control harness



N700E VFD Settings for Marksman

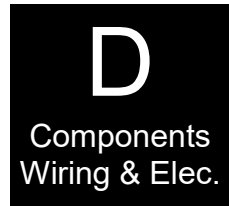

480 volt AC 3-phase input (Hyundai N700E VFD)

The Marksman variable frequency drive is factory programmed by SureFire and under normal conditions the user will not need to adjust anything on the VFD. However, for troubleshooting or special circumstances adjustments may be needed. The information is taken from the VFD manual to show the parameters SureFire customizes

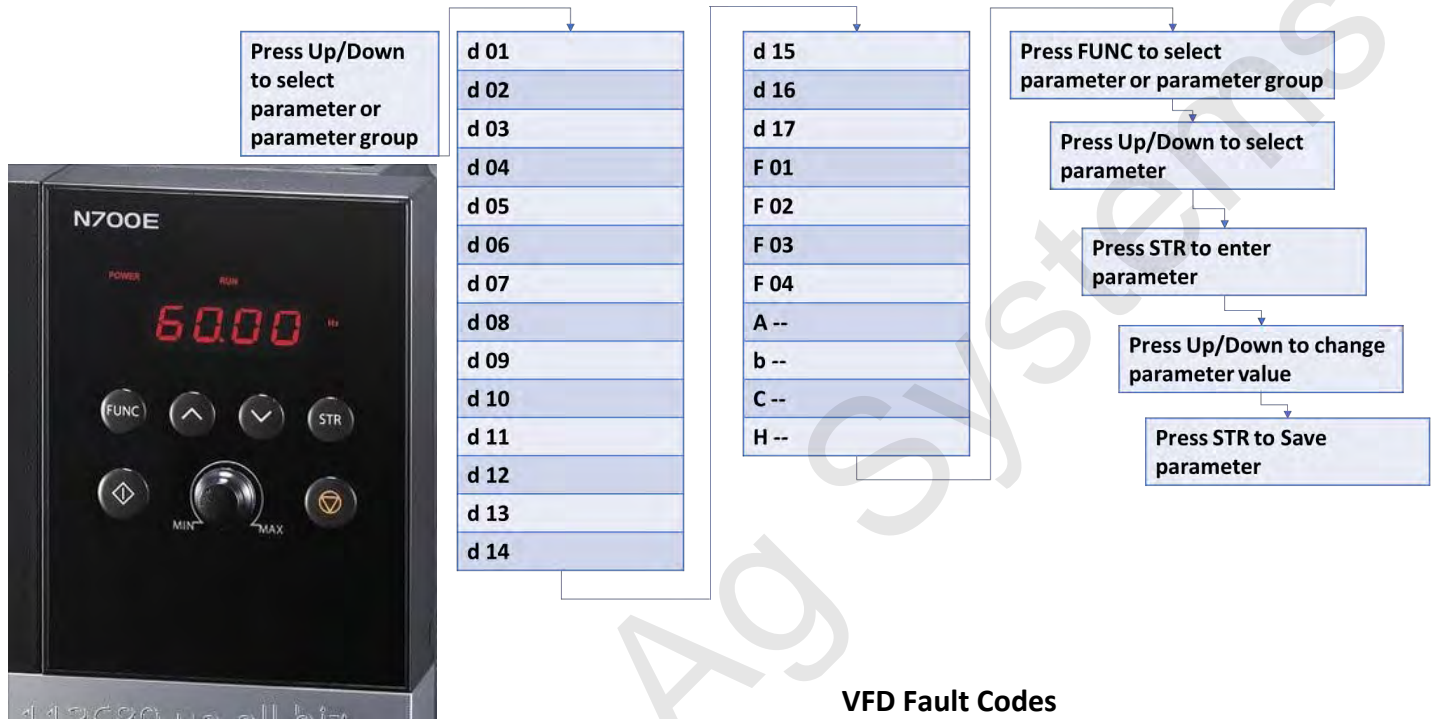

VFD Operating Information

The VFD display will show some information while running. Below is a partial list of some of the most helpful items you can view. Use the up/down buttons to move through these “d” group display parameters.

Parameter	Parameter Name	Description
d01	Output frequency monitor	Real-time display of output frequency to motor
d02	Output current monitor	Real-time display of output current to motor
d03	Output voltage monitor	Real-time display of output voltage to motor
d04	Rotation direction monitor	“F”orward, “R”everse, or “□”Stop
d08	RPM output monitor	Motor RPM
d12	DC link voltage	Internal voltage for troubleshooting

VFD Fault Codes

If an error occurs, the VFD display may show a fault code that begins with “E”. Use the chart below to help troubleshoot the problem. If you have either high or low voltage the first step will be to measure the input voltage to the Marksman with a voltmeter.

Fault Code	Name
E04	Overcurrent protection
E05	Overload protection
E07	Over voltage protection
E60	Communication Error
E09	Under-voltage protection
E04 or E34	Output short circuit
E13	USP Error
E08	EEPROM
E12	External Trip
E21	Temperature Trip
E14	Ground Fault

N700E VFD Settings for Marksman

480 volt AC 3-phase input
(Hyundai N700E VFD)

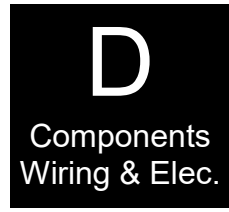

Default Settings

These are the settings SureFire sets to configure the VFD to work with the Marksman.

Parameter Number	Parameter Name	Marksman Setting	Description
F-02	Acceleration Time	0.3	The time to ramp from 0 to 100% speed
F-03	Deceleration Time	0.3	The time to ramp from 100 to 0% speed
A-01	Frequency Command	1	Use 4-20mA input for speed command
A-02	Run Command	1	Use external run command to start VFD
A-03	Base Frequency	65.00	Highest Frequency Available Setting
A-04	Max Frequency	65.00	Maximum Frequency Setting

Optional Settings

These settings can be changed for specific situations, but will not be SureFire default settings.

Parameter Number	Parameter Name	Marksman Setting	Description
B-01	Restart Mode	2	Use to allow the VFD to restart on low voltage (power shut off due to Pivot changing Direction)
A-32	V/F Characteristic Curve	2	Set to sensorless vector. This will allow the VFD to make the motor turn at lower output frequencies. Use if applying at a low rate and Marksman output is fluctuating.

The parameter below will reset the VFD and all parameters to factory defaults. After using Restore to Defaults you MUST reset the parameters listed above.

Parameter Number	Parameter Name	Setting to Restore Defaults	Description
B-12	Restore to Default	1	Set to 1 to restore factory defaults

Marksman VFD Control Box

120 volt AC single phase input

D
Components
Wiring & Elec.



The Marksman uses a variable frequency drive (VFD) to control the speed of a pump with a 3 phase AC motor. 120 volt single phase input power is converted to 240 volt 3 phase power in the VFD control enclosure which will cause death or serious injury. Disconnect power before servicing.

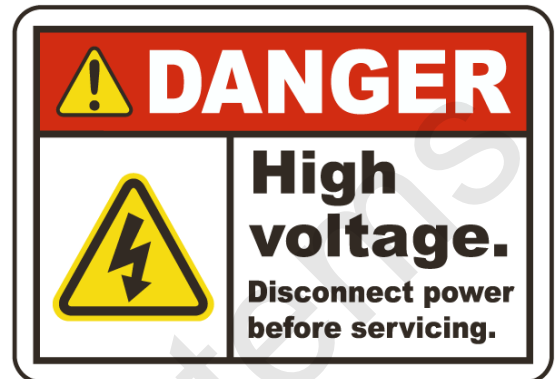

Power into VFD control box attaches to top of circuit breaker. This power will be on any time power supply is ON to Marksman, regardless of breaker switch position.

Relay provides signal for the VFD to turn output power on based on Marksman controller input.

Circuit breaker (6 amp) for input power. ON position is switch up (as shown) with red showing in the window under the switch.

Variable frequency drive (VFD) controls motor and pump speed based on 4-20 mA signal from Marksman. The variable frequency drive has a screen and input buttons. The VFD is setup by SureFire in the manufacturing process and should never require the operator to adjust settings in normal operation.

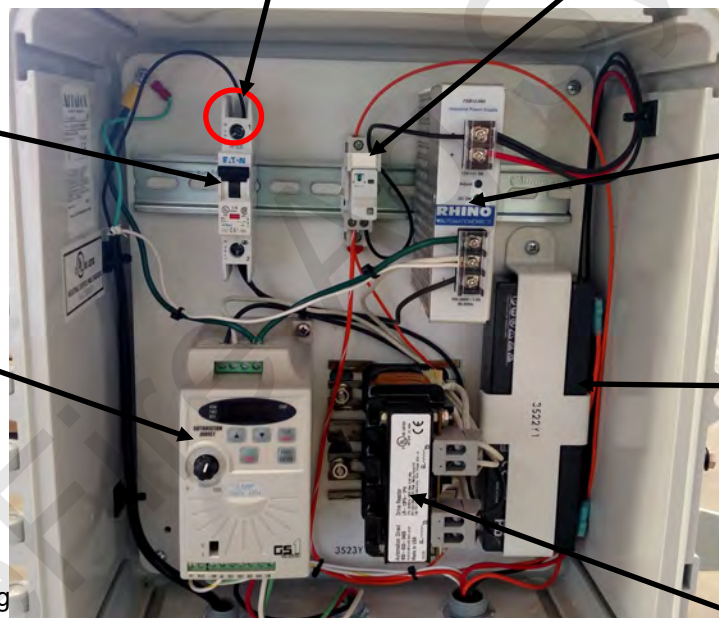

12 VDC Power Supply
Supplies power for Marksman controller from input 120 volt AC power (voltage set to 14.0 volts)

12 VDC battery for backup power to send power loss messages and close product valve

Variable frequency drive line reactor to protect electrical system from electrical noise generated by VFD.



240 VAC 3-phase connected directly to motor

6-pin Deutsch connector to Marksman control harness

Grounded 120 VAC plug for input power



GS1 VFD Settings for Marksman

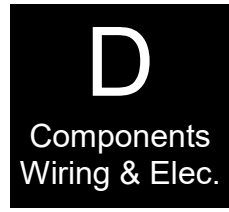

120 volt AC single phase input (GS1 AC Drive)

The Marksman variable frequency drive is factory programmed by SureFire and under normal conditions the user will not need to adjust anything on the VFD. However, for troubleshooting or special circumstances adjustments may be needed. The information is taken from the VFD manual to show the parameters SureFire customizes



Run/Stop Key and Potentiometer

The run /stop key and the potentiometer can be used to control the VFD. However, the Marksman is configured so the Marksman Controller handles these functions and the run/stop key and potentiometer have no function expect for troubleshooting.



Program/Enter Key

Press the PROGRAM/ENTER key to view parameters and store parameter settings.



Display/Reset Key

Press the DISPL/RESET key to cycle through the operational values (Status Display) of the AC drive. This key will also reset the AC drive when a fault has occurred.



Up/Down Keys

Press the UP/DOWN keys to scroll through the parameter set or to change parameter settings. Press the "Up" or "Down" key momentarily to change the parameter settings in single-unit increments. To quickly run through the range of settings, press and hold the "Up" or "Down" key.

VFD Operating Information

The VFD display will cycle through the 8 pieces of information shown at right. Push the Display/Reset key to cycle to the next item. Some of these items may be useful troubleshooting information.

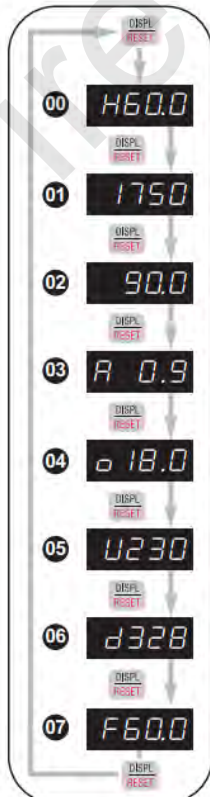

- 00 Actual Operating Frequency**
Displays the actual operating frequency present at the T1, T2, and T3 terminals. *Example: 60.0Hz*
- 01 RPM**
Displays the present *estimated* speed of the motor. *Example: 1750 RPM*
- 02 Scaled Frequency**
Displays the result of output frequency x P8.01. *Example: 60Hz x 1.5 = 90.0*
- 03 Amps**
Displays the output current present at the T1, T2, and T3 terminals. *Example: 0.9A*
- 04 % Load**
Displays the amount of load on the AC drive. *Example: (Output Current ÷ Drive Rated Current) x 100*
- 05 Output Voltage**
Displays the output voltage present at the T1, T2, and T3 terminals. *Example: 230V*
- 06 DC Bus Voltage**
Displays the DC Bus Voltage. *Example: 328 VDC*
- 07 Setpoint Frequency**
Displays the frequency setting of the AC drive. *Example: 60.0 Hz*

GS1 VFD Settings for Marksman

120 volt AC single phase input (GS1 AC Drive)

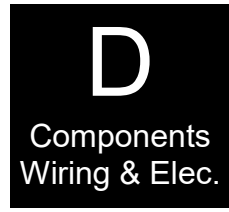

These are the settings SureFire sets to configure the VFD to work with the Marksman.

Parameter Number	Parameter Name	Marksman Setting	Description
P0.04	Motor Maximum RPM	1896	Sets maximum frequency based on max motor speed
P1.01	Acceleration Time 1	0.3	The time to ramp from 0 to 100% speed
P1.02	Deceleration Time 1	0.3	The time to ramp from 100 to 0% speed
P3.00	Source of Operation Command	1	Operation determined by external control terminals from Marksman controller. (for troubleshooting you can set this parameter to 0 to use the RUN/STOP keypad button)
P4.00	Source of Frequency Command	3	Frequency determined by 4-20 mA input on AI terminal being sent from Marksman Controller. AI switch must be set to "I". (for troubleshooting you can set this parameter to 0 to control speed with keypad potentiometer)

The parameter below will reset the VFD and all parameters to factory defaults. After using Restore to Defaults you MUST reset the parameters listed above.

Parameter Number	Parameter Name	Setting to Restore Defaults	Description
P9.08	Restore to Default	99	Set to 99 and push Program/Enter key. Default values will be restored and parameter will revert back to 0. Reprogram parameters above prior to Marksman operation.

VFD Fault Codes

If an error occurs, the VFD display may show a fault code. Use the chart at right to help troubleshoot the problem. If you have either high or low voltage the first step will be to measure the input voltage to the Marksman with a voltmeter.

Fault Code	Name	Fault Code	Name
oc	Overcurrent protection	ocA	Overcurrent during acceleration
ou	DC bus voltage high	ocD	Overcurrent during deceleration
oH	Over heat	ocn	Overcurrent during operation
Lu	DC bus voltage low	cF1 or cF2	Internal memory error
oL	Output current high	HPF	Hardware protection failure
oL1	Internal electronic overload	code	Software protection failure
oL2	Motor overload		

Marksman AC VFD Control Harness

208-08-3535Y3

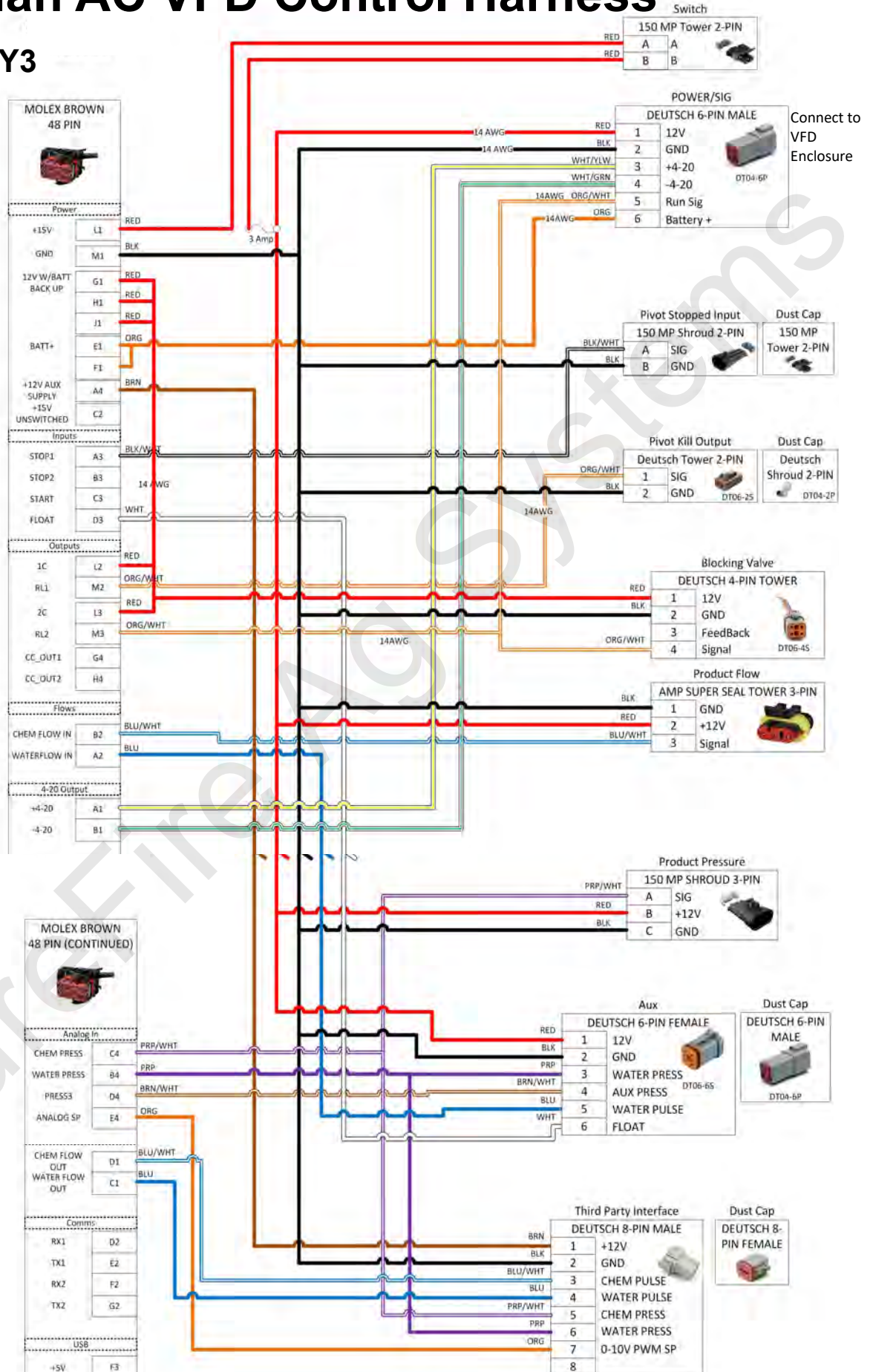

Marksman Accessory Items

Marksman Aux Function Adapter Harness 208-08-3548Y1

The Marksman aux adapter harness is required if you will connect a water pressure sensor or water flow meter. This adapter harness plugs into the 6-pin Aux connector on the Marksman control harness.

The Aux Pressure and Float connectors are for future Marksman features and are not functional as of mid-2017.

Water Flow Meter Compatibility

Marksman should be compatible with any water flow meter that produces a square wave output signal. Contact SureFire about specific flowmeter compatibility and extension harnesses for your meter. With a water flow meter Marksman will:

- Vary fertilizer or chemical flow proportionally to water flow. This will allow you to apply the correct rate of product in a corner swing arm system or any system where water flow and irrigated area vary.
- Send water flow reading and total to Marksman website for remote monitoring.

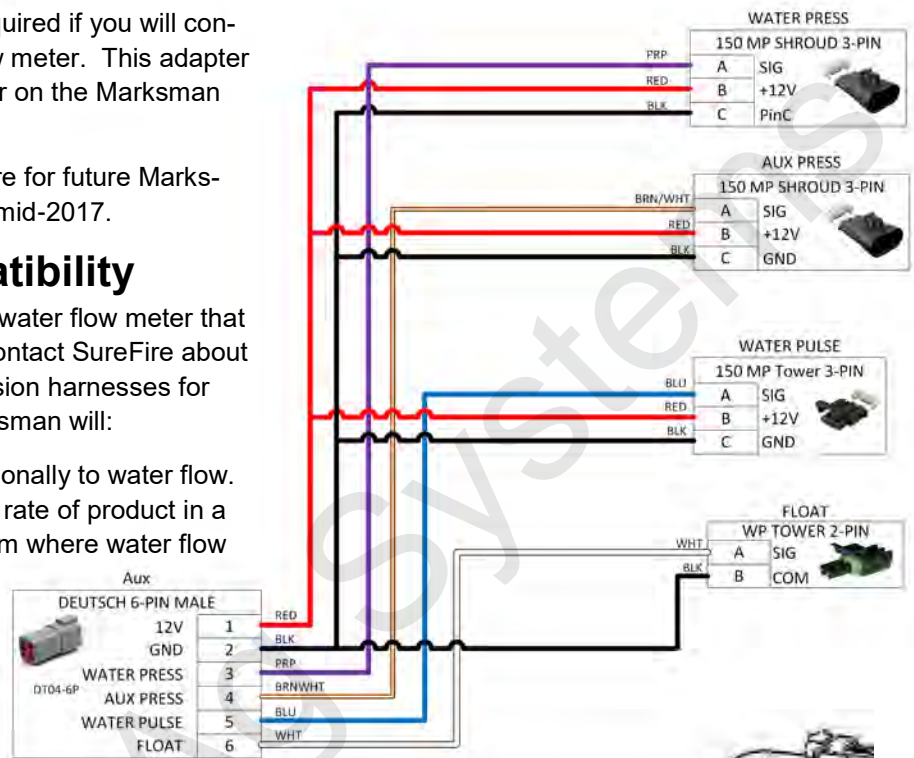

0-400 PSI Pressure Sensor Kit for Marksman 521-05-050400

Use this pressure sensor if you want to connect your Marksman to digitally read water pressure. It includes the sensor w/ 1/4" MPT connection and 2' connector harness. It is the same sensor used on the Marksman for chemical pressure too. With a water pressure sensor your Marksman will:

- Shut down if water pressure is too low (one method to shut off Marksman if irrigation system shuts down). User must set low pressure setting.
- Shut down if water pressure is too high. User must set high pressure setting.
- Send water pressure reading to Marksman website for remote monitoring

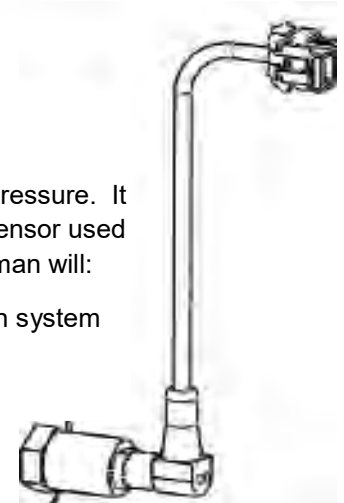

3 Pin Metripack 150 Extensions for pressure sensors

You will most likely need an extension harness to connect the water pressure sensor to the Marksman (the included harness is only 2' long). Choose the length to reach from the Marksman to the pressure sensor location.

5 feet	206-03-13205
10 feet	206-03-13206
15 feet	206-03-13207
20 feet	206-03-13208
25 feet	206-03-13209
50 feet	206-03-13419

Marksman Accessory Items

Marksman Third Party Compatibility Adapter Harness 208-08-3534Y1

The third party compatibility harness is designed to allow Marksman to communicate with the AgSense CropLink. With a connection to CropLink you can use AgSense to:

- Monitor Chemical Pressure
- Monitor Chemical Flow
- Monitor Water Pressure
- Monitor Water Flow
- Command Marksman Rate for variable rate application

Marksman also provides power to the CropLink box (red and black wires) so no other power source is required for CropLink.

Route the 7 wires on harness 208-08-3534Y1 through a grommet already in the bottom of the CropLink box. Attach to terminal blocks as shown in the diagram at right. Plug the 8-pin connector into the Marksman harness connector labeled "Third Party Interface".

The harness is 8 feet long so no extension is required in many cases. If mounting CropLink over 8' from the Marksman order the correct 8-pin extension.

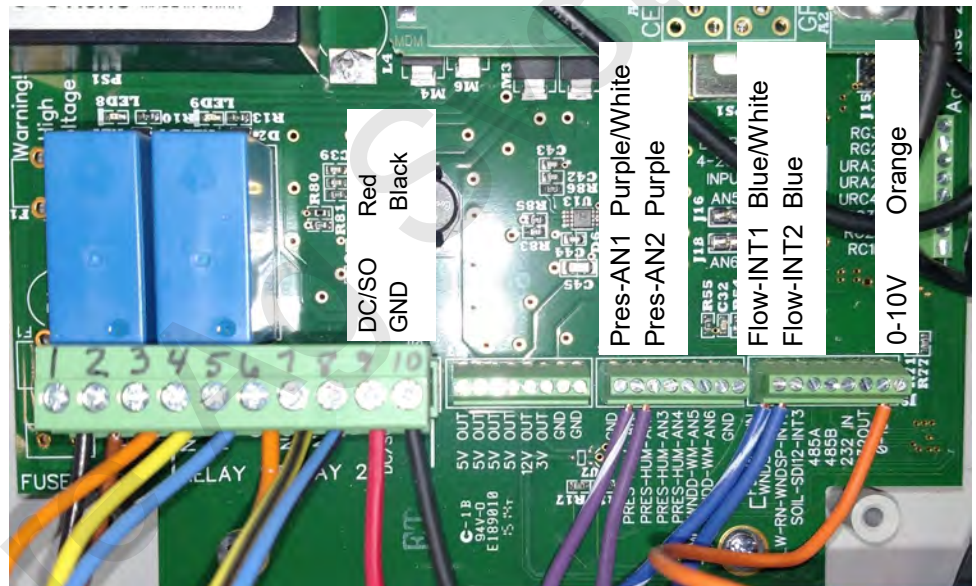
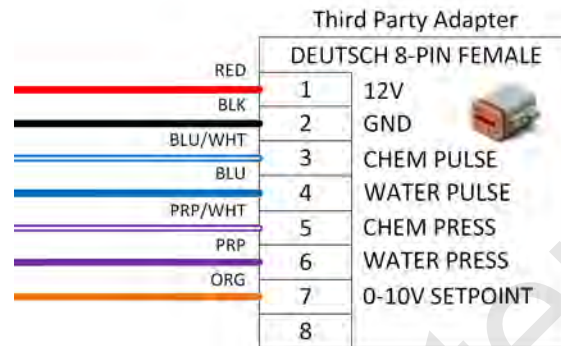

KEYS

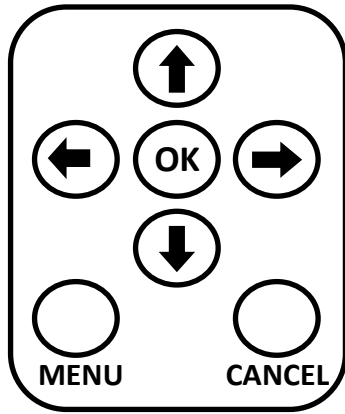

The Injection Controller is controlled by 7 keys on the front panel.

MENU

The menu key is used to enter the advanced menus. Press and hold MENU for 3 seconds to enter the advanced menus. Press MENU again to exit any menu and return to the home screen.

CANCEL

The cancel key will stop the pump, exit any menu and return you to the front screen. On the Diagnostic 1 and 2 screen CANCEL will stop the pump and not return you to the home screen so you can continue any troubleshooting activity.

OK

The OK button will start the pump when on the front screen. In the menu screens, the OK key will enter and exit programming fields. The OK button will also start the pump on the Diagnostic 1 screen for troubleshooting in the advanced menus.

ARROW KEYS

The **up and down arrow keys** are used to navigate up and down the menu pages. After selecting a menu item, the up and down keys are used to increase or decrease the value. If the value is a list of choices, the up and down keys will scroll through the available choices.

The **left and right arrow keys** are used to select which digit to change when changing a number in the menus. Also, the left and right keys will let you move between menu pages forward or backward one page.

MENU STRUCTURE

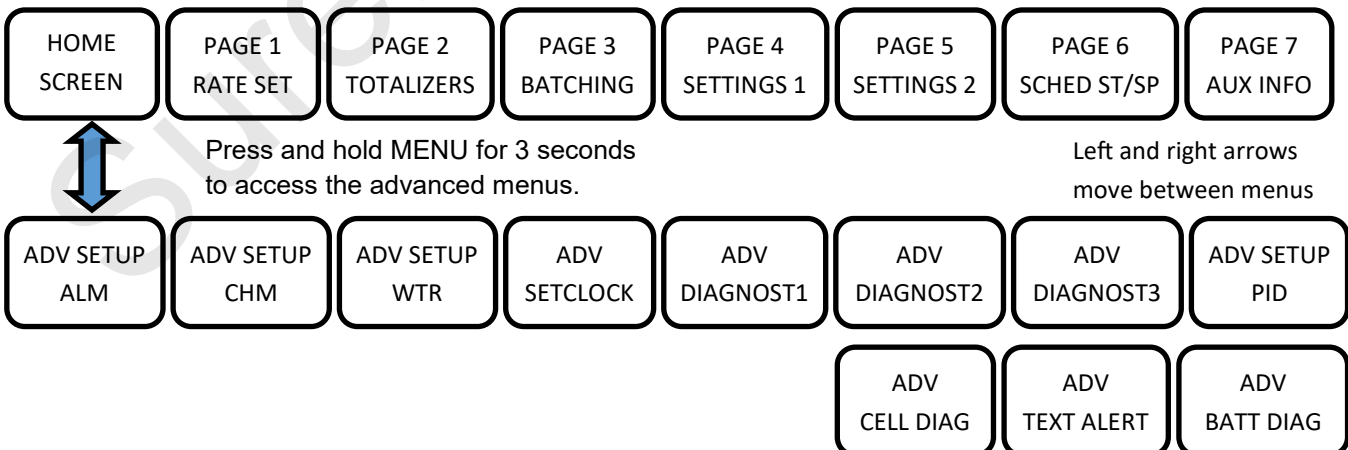

* After 5 minutes of inactivity, the controller will exit advanced menus and return to the home screen

HOME SCREEN

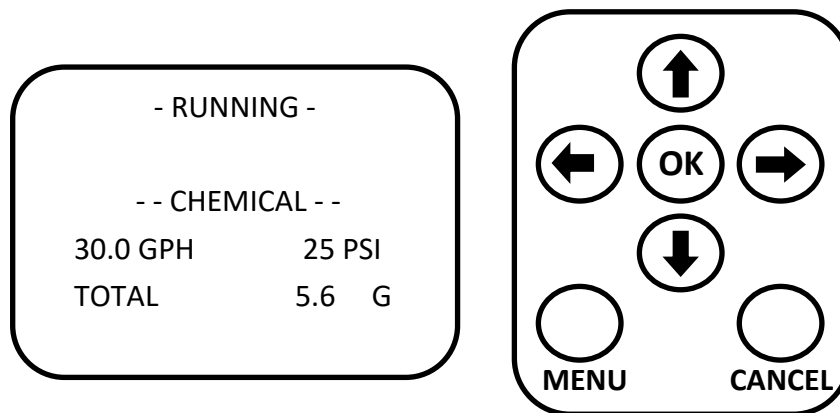

The main screen of the injection controller is shown above. This screen communicates the current status and operation of the unit.

STATUS LINE

The top line currently shows RUNNING, which is the status when pumping. When the pump is stopped (and not in an alarm condition) the status will show STOPPED. If a start delay is used, DELAYED START will be displayed with seconds remaining. When a scheduled start or stop is active, it will periodically flash SCHED STRT&STP. If calculated tank alarm is used and is below the set alarm value, LOW TANK LEVEL will periodically flash. In the event that batch irrigation kill delay is being used, IRRIG KILL DELAY will be displayed along with minutes remaining. If an alarm event occurs, the top line will show the error message. See section G for a full list of error messages and troubleshooting steps for each.

CHEMICAL (FERTILIZER) STATUS

This section will indicate the current operation of the injection unit. The screen above is showing a current injection rate of 30.0 GPH (gallons per hour). This may be displayed in other units which are set on RATE SET screen. The screen above shows 25 PSI from the pressure sensor.

The TOTAL line shows the amount dispensed in the current batch. TOTAL (BATCH TOTAL) resets in two ways.

- If using the batch function (BATCHING) the TOTAL counts up until the batch amount is reached and then injection automatically stops. TOTAL will continue to show the batch total after product stops dispensing. When OK is pressed again, the batch will automatically reset to 0.0 and another batch will be dispensed.
- The TOTAL may also be manually reset on BATCHING screen.

If the batch function is enabled a SPT line will appear below TOTAL. This will display the setpoint for the batch. This line will be blank when batching is disabled.

WATER STATUS

This section will indicate the current water flow and pressure in the irrigation system if water flowmeter and/or pressure transducer are connected. The water flow will display in G/MIN and the pressure in PSI.

REMOTE RATE

If remote setpoint is enabled (SETTINGS 1), water status will be replaced by the current target commanded by the remote device.

MENU 1/7 RATE SET

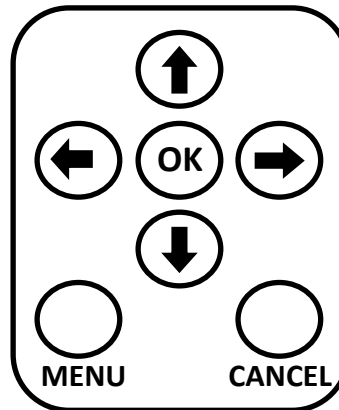
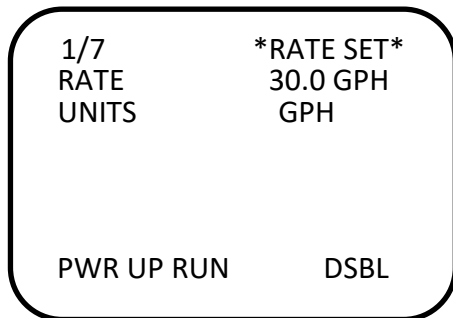

From the HOME screen, press right arrow once to access this page.

RATE

Set the desired application rate. The units shown above are GPH (gallons per hour). Change the units before setting the application rate.

UNITS

This sets the units the application rate will be set and measured in. This can not be changed while running.

ML/M Milliliters per minute (see box to right)

GPH Gallons per hour

OZ/M Ounces per minute

GPM Gallons per minute

G/AC Gallons per acre—for use with center pivots, requires setting pivot length and speed on menu 5/7

OZ/AC Ounces per acre—for use with center pivots, requires setting pivot length and speed on menu 5/7

Milliliters / Minute Operation

1. Set the UNITS to ML/M
2. The calibration number will automatically be converted to pulses / liter and totals will be converted to liters once this screen is exited; it will show PULSES/L on ADV SETUP CHM page and totals in L. For the default 3000 PULSES/G, it will convert to 793 PULSES/L.
Conversion: $3000 \div 3.78 \text{ L/gal} = 793$

POWER UP RUN

With this mode turned on (ENBL—enable), the pump will immediately begin running when the power is turned on. If used in conjunction with Batch mode enabled, the controller will dispense the batch amount every time the power is turned on. If it didn't complete the batch before it was turned off, it will complete the batch instead of starting over.

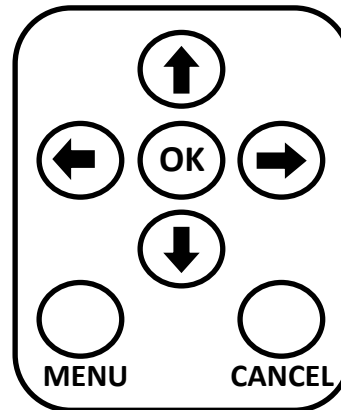
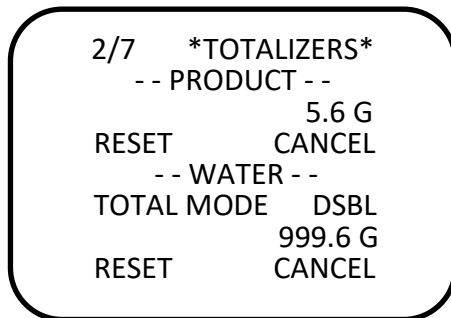

PRODUCT TOTALIZER

The Product totalizer can be used for measuring any total the user desires (total on a field, total dispensed out of a tank, etc.). The Product totalizer is only reset by choosing reset on this page (or the website if applicable). The Product totalizer is saved to memory and will not reset on power down.

If using the mL/M (Milliliters per minute) units the batch total will be set in Liters.

The Product totalizer will rollover back to zero at 100,000,000 (Gallons or Liters)

PRODUCT TOTALS IN METRIC UNITS

If using the mL/M (Milliliters per minute) units the user and batch total will be in liters. If you switch to mL/M units, the current total will be converted to liters. They will also convert back to gallons when US units are selected.

WATER TOTALIZER

The Water totalizer can be used for measuring the water usage if a water meter is connected to the Marksman. The Water totalizer is reset by choosing reset on this page (or the website if applicable). The Water totalizer is saved to memory and will not reset on power down.

Water is totalized in either G or L, depending on what is selected on the ADV SETUP WTR page.

The Water totalizer will rollover back to zero at 100,000,000 (Gallons or Liters)

WATER TOTALIZER MODE

There are three settings for totalizing water:

DSBL Water is not totalized although water rate will still be reported

MARK Water is only totalized while the Marksman is pumping

ALWY Water is totalized anytime the meter reports flow

If water is in ALWY mode, the Marksman will continue to record info to update the water total every hour or when water flow drops below 25 GPM when the product pump isn't running.

3/7 *BATCHING*	
BATCH	ENBL
SPT	200.0 G
TOTAL	123.4 G
RESET	CANCEL
IRRIG KILL	DSBL
PK DLY	2MIN

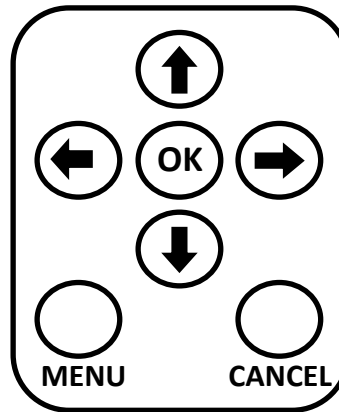

BATCH

This turns on or off the batch function; set to ENBL (Enable) or DSBL (Disable). When enabled, the controller will dispense up to the setpoint and turn off. When disabled, the controller will run at the application rate indefinitely until turned off by some other input (CANCEL button, remote stop input, etc.) **When enabling the batch function also reset the batch totalizer to zero.** The totalizer will not reset to zero the first time batch is enabled. However, when each batch is complete, the totalizer will reset to zero when a run command is given again to start the pump and dispense another batch.

BATCH SPT

The batch setpoint is the amount to dispense in each batch in gallons (or liters if ml/m is the rate unit). When BATCH is disabled, this setting is not used. If BATCH SPT is set to zero and BATCH is enabled, the system will not batch, but pump continuously.

TOTAL

This is a totalizer independent of the Product totalizer on the previous page. The BATCH totalizer will count up until the batch setpoint is reached. When a run command is given again, the batch totalizer will reset and once again dispense the batch setpoint. The Batch totalizer will also keep its value on power down or power loss. If the batch is stopped (manually, power loss, or by another alarm) before it is completed, the batch total it will resume where it left off when the pump is started again. If a complete batch is desired in these situations, the batch must be reset using the batch reset on this screen.

If you are NOT using the batch function, this totalizer can be used for information and the BATCH totalizer can be reset by the user on this screen if desired.

IRRIG KILL

The default setting is that the irrigation kill output is not turned on when a batch is completed, but only for alarm conditions. If a irrigation kill is desired at the end of the batch, it can be enabled here. "IRRIG KILL DELAY" will display on the front screen with minutes remaining if active.

IK DLY

The irrigation kill delay determines how long (in minutes) the Marksman will wait before issuing a irrigation kill output on batch completion. This may be useful for flushing the system before shutdown. 0-65535 Minutes

MENU 4/7

SETTINGS 1



4/7	*SETTINGS 1*
WATER SPT	DSBL
SPT	200.0 GPM
REMOTE SPT	DSBL
MAX	100.0 GPH
MIN	0.0 GPH
ROFF	1.0 GPH

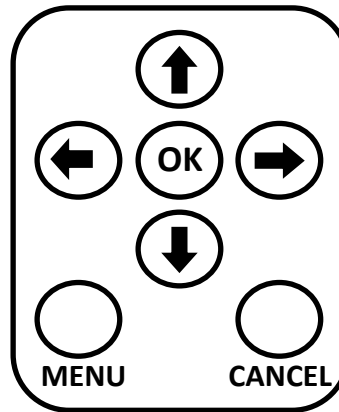

WATER

This turns on or off the water proportional mode with rate control based on water flow rate; set to ENBL (Enable) or DSBL (Disable). An optional water flowmeter must be connected to use this function. Set the water flow meter calibration on ADV SETUP - WTR page.

WATER SPT

The water setpoint is the water volume at which the application rate (RATE on Menu 1/7) will be dispensed. As the water flow increases or decreases from this setpoint the application rate will vary. With a setpoint of 200.0 GPM, when water flow is actually 100 GPM, the application rate will be 50% of the rate shown on menu 1/7. When the water flow is actually 250.0 GPM, the rate will be 125% of the rate shown on menu 1/7.

REMOTE SPT

Remote rate is used for prescription injection. The controller will accept a voltage varying from 0-5 volts. At 5.0 volts, the MAX rate will be applied (100.0 GPH shown above). Also set the ROFF setting on PID SETUP page when using this mode. BATCH mode cannot be used with REMOTE SPT mode.

REMOTE RT MAX

The application rate when signal voltage is 5.0 volts.

REMOTE RT MIN

The application rate when signal voltage is 0.0 volts. SureFire recommends setting this at 0 GPH.

ROFF

This setting is used with prescription control for remote rate. Any incoming signal lower than ROFF setting will turn off the Marksman pump.

NOTE: RATE on menu 1/7 will show the calculated rate based on input voltage when REMOTE RT is enabled. However, you will have to leave menu 1/7 and come back to the page to see the RATE update based on a voltage change.

MENU 4/7

SETTINGS 2



5/7	*SETTINGS 2*
FIELD #	1
PIVOT FT	1300
FEET/MIN	2.5
LOG INT	10 MIN
WTR INT	60 MIN
START DLY	0 MIN
13:03	01/08/18

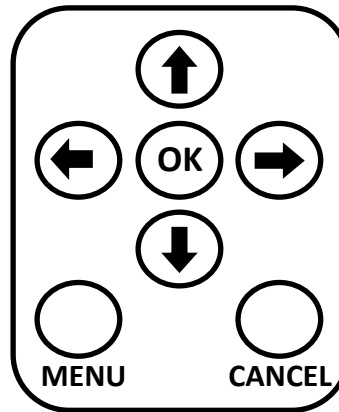

FIELD

Field # is user settable to identify what field the chemical or fertilizer application is being made on. This will be recorded in the USB log file and transmitted to the website if equipped with remote access.

PIVOT FT

The pivot feet setting is only needed if using the gallons or ounces per acre units (Menu 1/7). If using those per acre units, the controller will calculate the area covered and apply the correct rate per acre.

FEET / MIN

The speed of the end of the pivot in feet per minute needs to be entered to apply in per acre units also. The most accurate way to get this number is to actually measure how far the end of the pivot moves and time that movement for 2 -3 cycles of the end tower moving.

NOTE: Pivots with corner swing arm can use both the per acre application units and the proportional water control. The pivot feet will be set to the length for the standard pivot less swing arm. The pivot speed will be the speed at that point (less swing arm). Then, when the swing arm is engaged, the water flow increases. The controller will detect this increased water flow and increase the water rate proportionally. The end result is accurate application over the entire watered area.

LOG INT

The controller can keep a log of application info on a USB drive and send the same data to the SureFire website if equipped with a modem. The log function is turned off if set to zero. You can set an interval from 1 - 30 minutes. If equipped with remote access, the controller will send data to the website. The default setting is 10 minutes and additional data charges may apply if set to less than 10 minutes.

WTR INT

When the controller is in Water Totalizer mode of 'ALWY' and the Marksman is not pumping product, data will still be logged at this interval to record water totals. Default it 60 minutes. If set to zero, data is not logged if Marksman is not pumping product.

START DLY

The controller can delay 0-99 minutes after a start command is received before running. "DELAYING START" will display on the front screen with seconds remaining. If a stop command is received during the delay, the count is reset and the start command is canceled. Set to 0 if no delay is desired.

TIME AND DATE

Date and Time displayed here (see Advanced Menu to set time). If using the remote connectivity modem the time can be auto set via the cellular network.

MENU 6/7 SCHEDULED START/STOP



6/7	*SCHED ST/SP*
STRT MODE	DSBL
HOUR	8
MIN	15
STP MODE	DSBL
HOUR	20
MIN	59

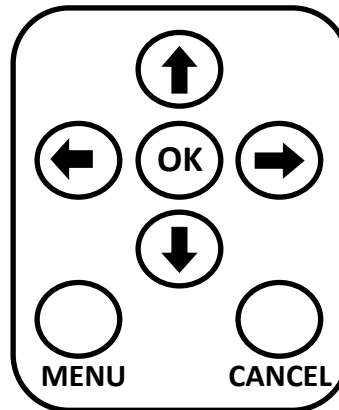

SCHEDULED STRT/STP MODE

The Marksman has a scheduled start and stop feature which has three modes:

- DSBL No scheduled start or stop
- ONCE The scheduled start or stop will occur once. After the event is triggered, the mode will change to DSBL.
- REP The scheduled start or stop will repeat whenever the trigger time is encountered.

STRT/STP HOUR/MIN

This is the scheduled time that the start or stop will occur. This time is specified in 24 hour format (8 PM = 20, 12 AM=0). To prevent the user from inadvertently causing a start or stop event while setting the scheduled time, the mode will be placed in DSBL automatically whenever the time is adjusted. After the time is set, the user must then select the mode (ONCE or REP).

If a ONCE start or stop is set, but the unit is already in the desired run state when the scheduled time is crossed, the mode will still be changed to DSBL. The one time start or stop command will be “used up” any time the scheduled time is past.

BATCH MODE AND SCHEDULED STRT/STP

Batch mode can be used with scheduled start / stop. You could set a scheduled start time and enable batch mode. Marksman will start at the scheduled time, dispense the batch amount. You could use a ONCE start do just do this one time, or a REP start to dispense the batch amount every day at the set time. A scheduled stop time would not be used in this case.

Batch mode can be used with a scheduled stop. If the batch completes before the scheduled stop occurs, the Marksman will stop. If the scheduled stop occurs before the batch is complete, Marksman will stop. However, the next time Marksman starts it will finish the remainder of the batch.

EXAMPLE 1

At 8:15 AM, a user sets a ONCE start time of 8 AM and a ONCE stop time of 8 PM (20:00). The Marksman will issue a stop that evening and will start again at 8 AM the next morning and keep running.

EXAMPLE 2

At 1 PM (13:00), a user sets a REP start time of 7 PM (19:00) and a ONCE stop time of 10 AM. The Marksman will start up that evening and run until 10 the next morning. Because REP was selected for the start, the Marksman will start again that next evening and keep running.

**Timed Start/Stop is ignored when Remote Setpoint is enabled.

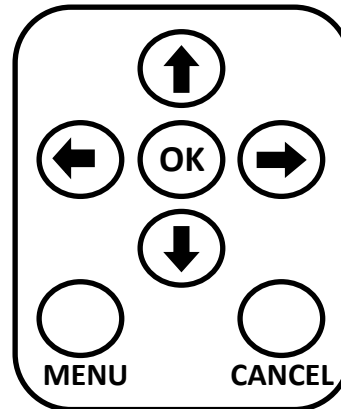
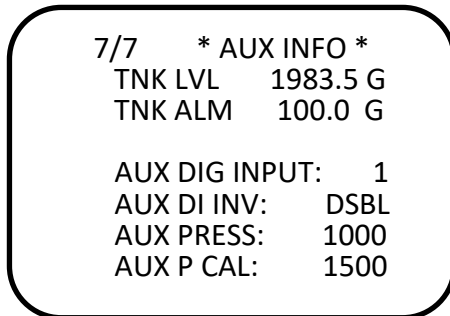

TNK LVL

This is a tank level estimate based off of starting value and usage recorded by the flow meter. It is essentially a totalizer that counts down to zero. If using the mL/M (Milliliters per minute) units for rate setpoint, the tank level will be in liters. This value automatically converts G<->L when the rate unit is changed. When the tank is filled or at a known value, the current level can be edited by the user. This value can be edited while running. 6553.5 G or L is the maximum value.

TNK ALM

Once tank level is at or below this value, an alarm is shown on the front screen. This will not shut down the Marksman, it is a visual alarm only. Setting this value to 0 disables the alarm.

AUX DIG INPUT

This shows the state (1 or 0) of the auxiliary digital input. This input is called **FLOAT** on the Aux Adapter harness. When a connection is made between the two wires of the connector, the state changes to 1. This input can be inverted with the AUX DI INV setting below. If it is desired to have this input stop and alarm the Marksman, contact SureFire. Advanced settings will need to be changed. The system will then be in alarm when the state shows '1'.

AUX DI INV

When enabled, this setting inverts the state of the auxiliary digital input.

AUX PRESS

This displays the current value of the auxiliary pressure. This input is called **AUX PRESS** on the Aux Adapter harness. It can be used to display the value of any 0-5VDC signal and is scaled depending on the value of AUX P CAL.

AUX P CAL

This is the calibration number for the AUX PRESS reading. AUX PRESS will read 0 at 0VDC. Set this number to what value is to be displayed when incoming voltage is at 5VDC. Readings in between will be scaled linearly. 65535 is the max value.

ADVANCED MENU - ADV SETUP-ALM

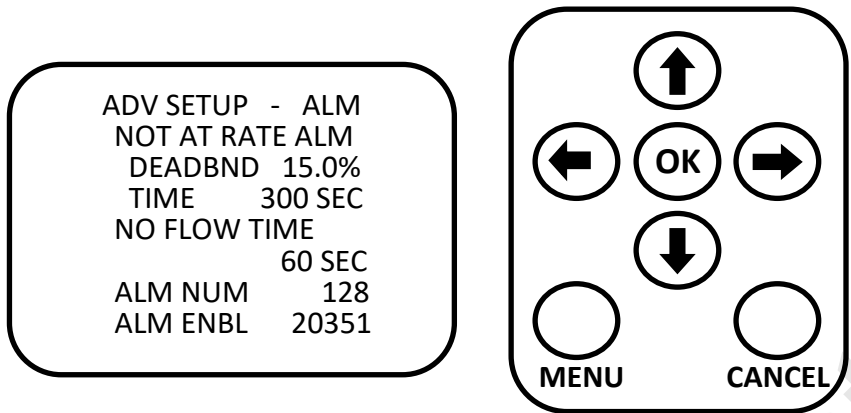

NOT AT RATE ALM

This alarm sets the percent off rate when the unit will shut down. As shown here, the unit will have to be 15% above or below the set rate amount for 300 seconds (5 minutes). If these conditions are met the unit will shut down automatically. You can increase or decrease the **DEADBAND** and **TIME** settings. Deadband can be set from 15-100% and Time can be set from 10-65535 sec.

NO FLOW TIME

If the chemical flow goes to zero, the unit will shut down after this many seconds. As shown on the screen, the unit would shut down after 60 seconds at zero flow. Time can be set from 10-65535 sec.

No Flow Time also will apply to the water flow if water proportional control is enabled.

ALM NUM

Alarm number shows which alarms are currently in alarm state. Consult with SureFire to interpret this number if necessary.

ALM ENBL

This number determines which alarms are allowed to shut down operation. Consult with SureFire to interpret this number if necessary.

ADVANCED MENU - ADV SETUP-CHM

ADV SETUP	- CHM
PRES HI	400 PSI
HI DLY	0 SEC
PRES LO	0 PSI
LO DLY	2 SEC
PULSES/G	3000
PRESS CAL	400 PSI
CONTROL	4-20

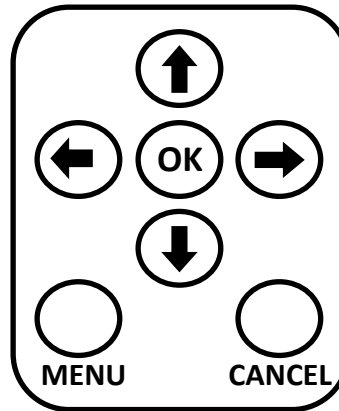

PRES HI

This is a high pressure shutdown point for the chemical / fertilizer being pumped. The pump will be turned off when this pressure is reached. High pressure shutdown is disabled when set to the PRES CAL value.

HI DLY

High Delay is the number of seconds the high pressure condition must be met before shutdown. If the pressure drops below the high setpoint, the timer is reset. 0-255 Sec

PRES LO

This is a low pressure shutdown point for the chemical / fertilizer being pumped. The pump will be turned off when this pressure is reached. Low pressure shutdown is disabled when set to zero. The low pressure alarm is ignored for 2 minutes after the pump starts to give the system pressure time to stabilize.

LO DLY

Low Delay is the number of seconds the low pressure condition must be met before shutdown. If the pressure rises above low setpoint, the timer is reset. 0-255 Sec. When the Marksman is first started, the controller waits 2 minutes to start checking for low pressure. If the low delay is set for 10 sec, the Marksman will alarm if the pressure is low for 10 seconds after the initial 2 minute starting period.

PULSES G

This is the pulses per gallon from the chemical / fertilizer flowmeter (pulses / L if unit selected).

- 3000 pulses per gallon for the SureFire 0.13—2.6 GPM flowmeter typically used on Marksman.
- 3785 pulses per gallon for the Seametrics flow meter (Model PE202-038) used on acid resistant Marksman.
- 22710 pulses per gallon for the SureFire 0.08 - 1.6 GPM flowmeter used on some Marksman.

PRES CAL

The controller uses a 0-5 volt pressure transducer. PRES CAL is the full range value of the pressure transducer. This is the pressure at which a 5.0 volt signal happens. Set to 400 for the standard Marksman pressure sensor.

CONTROL

Set to 4-20 for AC VFD Marksman systems. Set to PWM to control a 12 VDC pump with an electric pump driver (EPD).

ADVANCED MENU - ADV SETUP-WTR

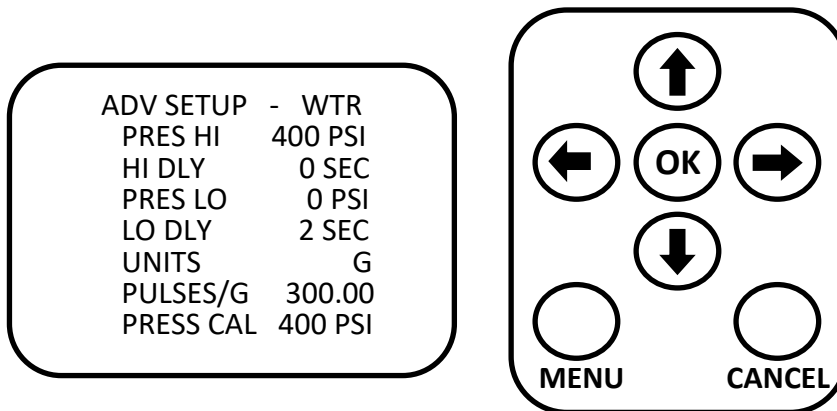

All items on this page are optional and are for the irrigation water being applied. If you are using the Water Proportional Control (Menu SETTINGS 1) the water flow must be connected and a flow calibration entered for the water flowmeter.

PRES HI

This is a high pressure shutdown point for water. The chemical / fertilizer pump will be turned off when this pressure is reached. High pressure shutdown is disabled when set to the PRES CAL value.

HI DLY

High Delay is the number of seconds the high pressure condition must be met before shutdown. If the pressure drops below the high setpoint, the timer is reset. 0-255 Sec

PRES LO

This is a low pressure shutdown point for water. The chemical / fertilizer pump will be turned off when this pressure is reached. Low pressure shutdown is disabled when set to zero. The low pressure alarm is ignored for 2 minutes after the pump starts to give the system pressure time to stabilize.

LO DLY

Low Delay is the number of seconds the low pressure condition must be met before shutdown. If the pressure rises above low setpoint, the timer is reset. 0-255 Sec. When the Marksman is first started, the controller waits 2 minutes to start checking for low pressure. If the low delay is set for 10 sec, the Marksman will alarm if the pressure is low for 10 seconds after the initial 2 minute starting period.

UNITS

This determines whether to use G or L for water total and flow rate.

PULSES/G

This is the pulses per gallon from the water flowmeter (pulses / L if unit selected).

PRES CAL

The controller uses a 0-5 volt pressure transducer. PRES CAL is the full range value of the pressure transducer. This is the pressure at which a 5.0 volt signal happens. Set to 400 for the standard Marksman pressure sensor.

See Marksman accessory items in this manual for pressure sensor and extension cables to connect to the Marksman.

ADVANCED MENU - ADV - SETCLOCK

ADV - SET CLOCK	
HOUR	23
MIN	59
MONTH	1
DAY	11
YEAR	18

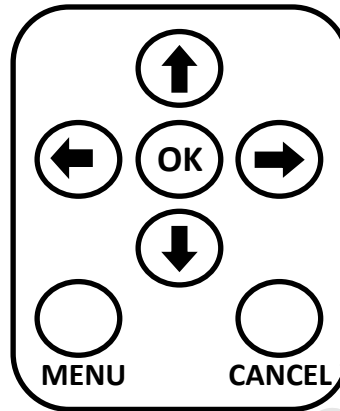

HOUR

Enter hour in 24 hour format.

MINUTE

Enter minutes.

MONTH

Enter month

DAY

Enter day of the month

YEAR

Enter the last two digits of the year.

If the Marksman is equipped with remote access, the time can be automatically set from the time received via the cellular network. This feature can be disabled (on CELL DIAG menu) and the time set manually. This may be desirable if you are near a time zone change and the cellular network may pick up a tower in the adjacent time zone.

ADVANCED MENU - DIAGNOST 1



```
ADV - DIAGNOST 1
CHM PR      0 PSI
CHM         0 Oz/M
CHM         0 GPA
CHM         0 GPM
CHM         0 GPH
           0Hz F 0.00%
SP=         0 PV   0
```

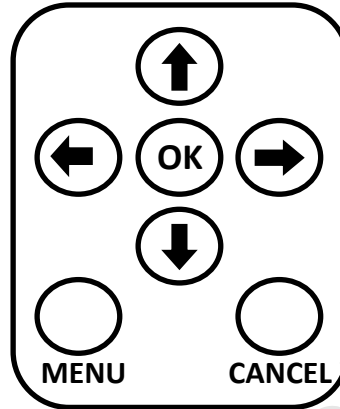

CHM PR

Displays chemical pressure in PSI.

CHM (1-4)

CHM on the Diagnostics screen displays the calculated flow or application rate in multiple units. These values report raw flowmeter feedback and can be used for diagnosing any performance issues. These values have no averaging so they will always fluctuate and never lock on to the application rate.

FLOWMETER FEEDBACK IN Hz

This reports the pulses per second received from the flowmeter.

Forward/Reverse

F or R will appear to indicate motor direction, only meaningful in servo valve operation.

4-20mA or PWM OPERATING PERCENTAGE

This displays the current 4-20mA or PWM percentage the pump is being commanded to run at. For 4-20mA, 0%=4mA and 100%=20mA.

SP & PV

These are internal control values that may be used for troubleshooting. SP is based on the rate setpoint. The controller is continually adjusting to make PV equal to SP.

ADVANCED MENU - DIAGNOST 2

```
ADV - DIAGNOST 2
MODE      AUTO
MANUAL%   50.00%
LAST STOP #: 0
CPU RST   130
RESTARTS: 0
RATE:     0.0GPH
LOG:      0.0GPH
```

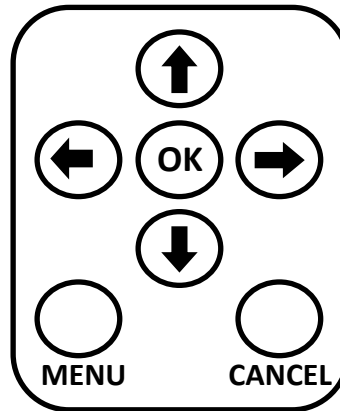

MODE

The mode of operation is either AUTO or MANUAL. Manual allows you to set the PWM or 4-20mA percentage directly. Manual is only used for troubleshooting. Always set to AUTO for normal operation.

MANUAL%

If the mode is set to manual, then the controller will start the pump at this percentage. This field is meaningless for normal operation in AUTO mode. Manual mode will not operate slower than Min PWM setting (Advanced Menu - PID). For example, you can set MANUAL to 10%. However, if MIN PWM (Advanced Menu - PID) is set to 20%, the controller will operate at 20%.

LAST STOP

This displays the last reason the pump was turned off. This information is sent to the website to aid in remotely diagnosing why a unit has shut down. The list of stop reasons is shown below

- 0=No Stop (the only time it will show 0 is after startup)
- 1=Stop 1 (connected to Pivot Stop Input in standard wiring harness)
- 2=Stop 2 (not used in standard wiring harness)
- 4=Water Pressure High
- 5=Water Press Low
- 6=Chem Press High
- 7=Chem Press Low
- 8=USB Error
- 9=No Chem Flow
- 10=Chem Off Rate SP
- 11=No Water Flow (only active in Water Proportional Control mode)
- 12=Power Loss (message created via battery backup)
- 13=Aux Input (when enabled in advanced alarm settings)
- 14=Batch Done Pvt Kill
- 15=Memory Error (Memory was set to defaults due to an error)
- 32=Remote Stop (through website)
- 33=Controller Push button (cancel)
- 34=Batching Operation completed
- 35=Remote STP Mode Turned Off (signal below ROFF setting, see Advanced Menu PID)
- 36=Scheduled Stop

CPU RST / RESTARTS

CPU RST is for processor troubleshooting and RESTARTS will increment every time the processor turns on.

RATE

This is exactly the same rate displayed on the HOME screen. It is shown here to aid in troubleshooting without exiting the advanced menus.

LOG

This rate is sent to the website and the log file. The LOG rate is a longer duration average to aid in remote monitoring.

ADVANCED MENU - DIAGNOST 3

```
ADV - DIAGNOST 3
VER:D_INJECTV1.3.1
ID:7855552186
CHM PLS  0
WATR PULSES  0

USB READY
```

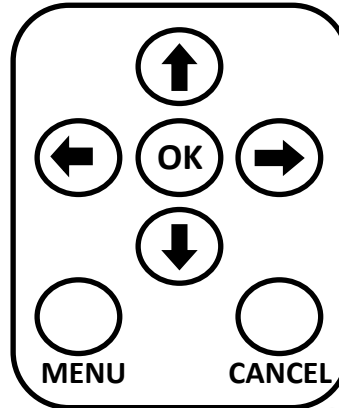

VER

This shows the software version installed on the controller.

ID

The ID will be the phone number of the cellular modem if present.

CHM PLS

This rolling counter shows the controller is receiving pulses from the chemical flowmeter. (0-255)

WATR PULSES

This rolling counter shows the controller is receiving pulses from the optional water flowmeter. (0-255)

USB STATUS

'USB READY' or 'INSERT USB' will display here depending on USB flash drive status.

ADVANCED MENU - PID

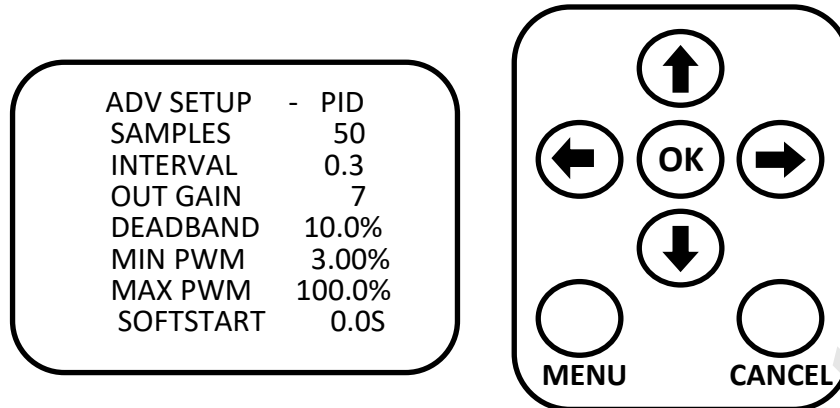

This screen will be used to adjust the control algorithm. If the unit is slow to respond, unstable, or otherwise not performing acceptably, these parameters may need adjusted.

SAMPLES

This is the amount of flowmeter pulses that will be used in a rolling average calculation. The default value is 50. To make the unit respond faster, reduce this number. To make the unit more stable (but slower to respond) increase this value.

INTERVAL

This is the time between PWM adjustments. A higher number causes the controller to adjust more slowly. Default value is 0.3 seconds. Recommended range is 0.1—1.0 seconds. If the rate is not stable and the PWM% is moving up and down quickly (likely causing instability) increase this value. You should see the PWM% adjust more slowly.

OUT GAIN

Out gain sets how large of an adjustment the controller can make. Default value is 7. Lower this setting if the controller is not able to lock onto rate. Increase the out gain if the controller needs to adjust faster to get to rate.

DEADBAND

Deadband is the % from target the controller will start making finer adjustments. Default setting is 10%. If the controller will not lock onto rate raise this setting.

MIN PWM

Min PWM is the minimum percentage the controller will command the pump to run at. Default value is 3%.

MAX PWM

Max PWM is the maximum percentage the controller will command the pump to run at. Default value is 100%.

SOFTSTART

The Marksman will ramp the pump up to speed over the soft start time setting. The default is 0 seconds.

Tips for Running at Lower Rates

At lower rates the PID settings may need modified. If the rate stays above the setpoint you may need to lower the MIN PWM. Watch the rate on the Diagnostic 1 Screen, if the rate (and PV) are bouncing down to zero increase the MIN PWM until this does not happen.

If the system is still not stable (typically at rates under 20 GPH) adjusting INTERVAL and DEADBAND are recommended. Increase INTERVAL to 0.4– 1.0. Increase DEADBAND TO 15-25%. These settings will make the controller slower to reach a new rate, but will increase the stability when running a rate under 20 GPH.

ADVANCED MENU - ADV - CELL DIAG

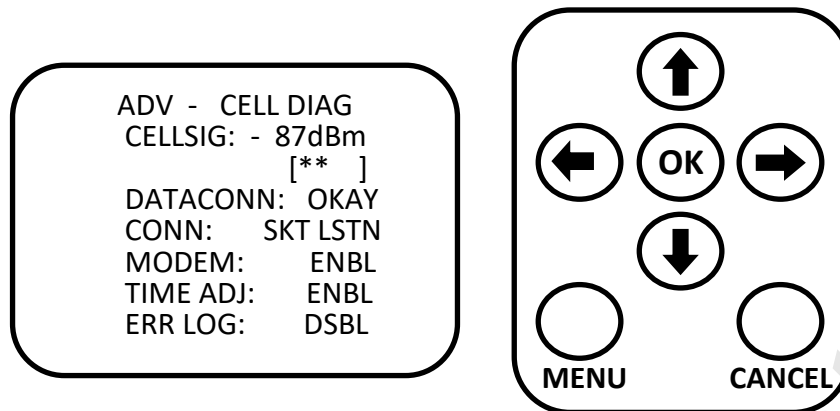

This screen is for the remote access cellular modem if equipped.

CELL SIG

This shows the strength of the cell phone signal. This value will vary from about 70—100. Below it is a cell phone strength graph using “*”. No * means you have no cell phone signal. One * is a weak signal up through a very strong signal of four *.

DATACONN

This displays if the modem is on the data network. Cell signal strength is not always a good indication of data service.

NONE = No Data Signal
OKAY = Data Signal

CONN

This displays the actual status of the cell modem. This should change from SCKT LSTN to SCKT CLSD to SCKT OPEN during normal operation with a good cell signal.

RESETTING = Modem is being initialized and trying to connect to network
NO COMMS = Error communicating with modem
NO PDP = No connection with network, possibly a poor signal
SCKT CLOSED = Connection to server closed
SCKT OPEN = Modem is transferring to or getting information from server
SCKT LSTN = Modem is listening for incoming communication from server

MODEM

This field must be set to ENBL (Enable) if a cell modem is attached. This can be set to DSBL if no modem is attached

TIME ADJ:

Enable this to automatically update the controller date and time with the date and time from the cellular network. If the date/time is more than 2 days off, the date/time will not be updated to prevent a bad date/time from the modem getting set. Set the date manually and the modem should update the time properly. The time adjust feature can be disabled and the time set manually. This may be desirable if you are near a time zone change and the cellular network may pick up a tower in the adjacent time zone.

ERR LOG:

This can be enabled to aid a SureFire technician if modem problems are occurring. It keeps a log on the USB flash drive of modem errors. This should be disabled unless directed to enable by SureFire.

ADVANCED MENU- ADV-TEXT ALERT

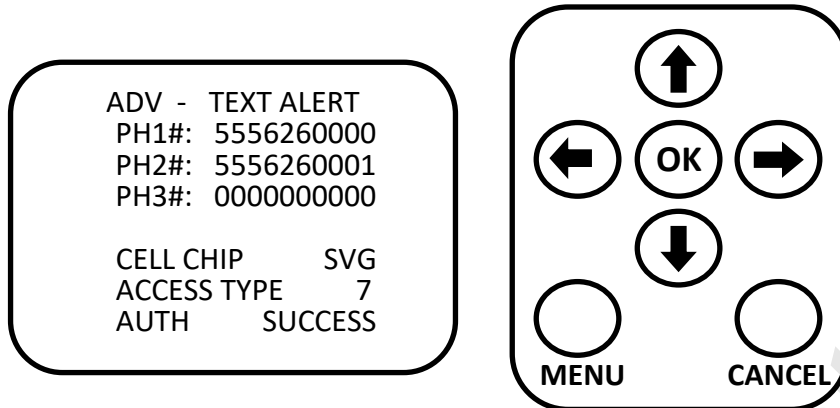

This screen is for setting phone numbers for text alerts

PH 1# - PH#3:

These are the phone numbers that will be sent text messages any time the unit starts or stops. Set the phone number on the controller using the arrow keys to set each digit. The phone numbers to send text messages to can also be changed from the website.

CELL CHIP:

This is for SureFire to identify what cellular modem is in the Marksman unit.

ACCESS TYPE:

This lets SureFire know what network the modem is connect to for troubleshooting.

AUTH:

This lets SureFire know what is going on with the Marksman's server authorization for troubleshooting purposes. In normal conditions, this should cycle between 'ATTEMPT' and "SUCCESS". Occasionally, the Marksman will need to renew its security token, so 'TOKEN FAIL', 'REF TRY' and 'CREATED' will appear during this process.

- (BLANK) = The modem is still initializing, no authorization information is known.
- ATTEMPT = Attempting communication with the server that requires security token.
- SUCCESS = Successfully transferred data with a security token, existing credentials are good.
- CREATED = Successfully obtained new security tokens.
- TOKEN FAIL = Communication has failed, the existing token has expired or is invalid.
- REF TRY = Attempting to obtain a new security token with an existing refresh token.
- REF FAIL = The existing refresh token is invalid, should attempt 'LOGIN TRY'
- LOGIN TRY = Attempting to obtain tokens with username and password.
- LOGIN FAIL = Username and password are incorrect, may require loading login information via USB

ADVANCED MENU - ADV - BATT DIAG

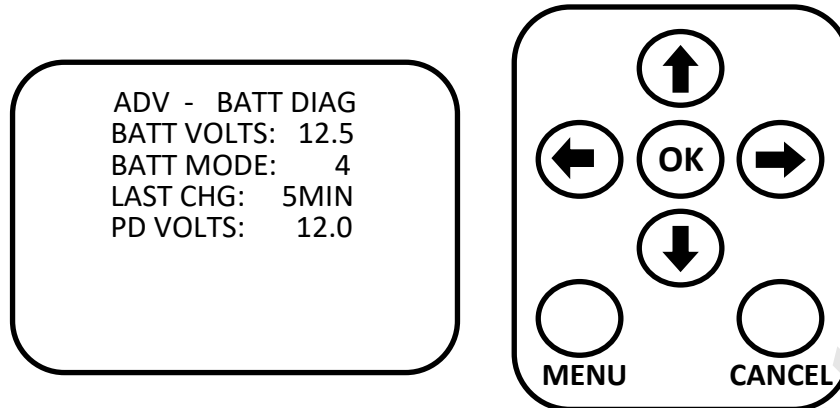

This screen is for battery information

BATT VOLTS

This is the voltage of the 12 VDC backup battery which is checked periodically

BATT MODE

The mode is what state the battery is currently in.

- 0=Currently checking battery voltage
- 1=Voltage sample taken
- 2=Battery is completely dead or a short is detected, charging will not occur.
- 3=Battery is very low and charging
- 4=Battery is OK and charging
- 5=Battery is full charged, not charging
- 6=Power loss detected, running off battery backup
- 7=Error

LAST CHG

This will display how long in minutes it took to recharge the battery to full voltage. It updates when the battery is fully charged.

PD VOLTS

This shows the voltage during the last power loss incident, while the controller was running off of battery backup. If this drops below 10, issues could start to develop during power loss incidents.

BATTERY BACKUP FUNCTION

The Marksman has battery backup to accomplish two functions.

1. Close the Marksman product valve. This prevents any chemical flow through the Marksman into the irrigation system or any irrigation water flow back into the chemical tank. Use of check valves and other regulations must still be met, but the valve closing provides an additional safeguard all flow will be stopped when power is lost.
2. Power the modem for notification of Power Loss failure via text message and website data upload.

Immediately when power is lost the Marksman will initiate shut down and complete the 2 items listed above. When the modem has successfully completed notification the controller will shut down. This could take up to 1 minute.

Error Messages & Troubleshooting

G

Troubleshooting

The Marksman controller has several alarms which will stop the pump. This is a list of these error messages and troubleshooting steps for each. These error messages are displayed on the top of the front screen.

Controller Message	Website Alarm & Stop Reason	Description and Troubleshooting Steps
NO CHEM FLOW	No Chemical Flow	<p>The controller is not receiving pulses from the chemical flowmeter. Either the flow has gone to zero or the flowmeter pulses are not being received by the controller. The time to receive this error is set on the ADV SETUP - ALM page under NO FLOW TIME. The default is 60 seconds to shut off with no flow detected.</p> <ol style="list-style-type: none"> 1. Check for empty tanks, closed valves, plugged strainers or other flow obstructions. 2. Verify if flow is present by taking the hose off the injection point or opening bleeder valve. Push OK to start pump and see if product is actually being pumped. 3. If product is not being pumped verify if pump is running. First, open the VFD box to see what Hertz is being sent to the pump. At 100%, the VFD should read 65 Hz. Feel pump and motor to see if you can feel any vibration indicating pump is 4. If product is being pumped check flowmeter connector and wiring for damage.
OFF RATE STP	Off Rate Setpoint	<p>The flow is too far off the set rate and has stopped the pump. The time and percent off rate to receive this error is set on the ADV SETUP - ALM page under DEADBAND % and TIME. The default is 15% off rate for 300 seconds (5 minutes).</p> <ol style="list-style-type: none"> 1. Is the rate set higher than the pump can achieve? If so, reduce rate or possibly reduce pressure so pump can achieve a higher flow rate. Check for partial blockages, especially on the inlet side such as a plugged strainer. 2. Is the rate set lower than the pump can achieve? If so increase the rate. You may be able to run the pump slower by reducing the MIN PWM on PID SETUP page. Raise MIN PWM until the display will never read zero flow with pump on. 3. Is the pump close enough to rate and you want it to continue to run? If so, increase the DEADBAND on the ALM page. 4. Is the pump oscillating around the rate? If so, check for fluid obstructions such as a blocked strainer. See page PID setup; increase INTERVAL, reduce OUT-GAIN and/or increase DEADBAND.
CHM PRES LO	Chem Press Low	<p>The chemical pressure has dropped below the PRES LO value on ADV SETUP-CHM page. This alarm is disabled for 2 minutes after starting the Marksman to allow stable chemical pressure to be achieved. After 2 minutes of runtime, the pump will stop immediately if the pressure drops below the PRES LO setting.</p> <ol style="list-style-type: none"> 1. Did a hose break or other failure occur causing pressure to drop? 2. What is your operating pressure at the current or a minimum flow rate? Set PRES LO 10-20 psi below this pressure. 3. To disable the low chemical pressure alarm set PRES LO to 0.
CHM PRES HI	Chem Press High	<p>The chemical pressure has increased above the PRES HI value on ADV SETUP-CHM page.</p> <ol style="list-style-type: none"> 1. What is your operating pressure at the current or a maximum flow rate? Set PRES LO 10-20 psi above this pressure. 2. To disable the high chemical pressure alarm set PRES HI to PRES CAL value.

Error Messages & Troubleshooting



The Marksman controller has several alarms which will stop the pump. This is a list of these error messages and troubleshooting steps for each.

Controller Message	Website Alarm & Stop Reason	Description and Troubleshooting Steps
WTR PRES LO	Water Press Low	<p>The water pressure has dropped below the PRES LO value on ADV SETUP-WTR page. This alarm is disabled for 2 minutes after starting the Marksman to allow stable water pressure to be achieved. After 2 minutes of runtime, the Marksman will stop immediately if the pressure drops below the PRES LO setting.</p> <ol style="list-style-type: none"> 1. Did a problem occur in the irrigation system causing low water pressure? 2. What is your irrigation water pressure? Set PRES LO 10-20 psi below this pressure. 3. To disable the low water pressure alarm set PRES LO to 0.
WTR PRES HI	Water Press High	<p>The water pressure has increased above the PRES HI value on ADV SETUP-WTR page.</p> <ol style="list-style-type: none"> 1. Did a problem occur in the irrigation system causing high water pressure? 2. What is your irrigation water pressure? Set PRES HI 10-20 psi above this pressure. 3. To disable the high water pressure alarm set PRES HI to PRES CAL value.
NO WATR FLOW	No Water Flow	<p>The no water flow alarm is only active if you have the proportional water control enabled (WATER on menu 5/7). In this mode, the Marksman will shut off if no pulses received from the water flowmeter after the NO FLOW TIME set on ADV SETUP - ALM page (default 60 seconds).</p> <ol style="list-style-type: none"> 1. Did a problem occur and water flow has stopped? 2. Did the water flowmeter wiring connection get unplugged or damaged? 3. Increase the NO FLOW TIME if this alarm is coming on too quickly.
USB ERROR		<p>This alarm means a good USB drive is not detected by the Marksman controller. The Marksman logs data to the USB drive in addition to sending it to the website. This alarm is not a shutdown alarm and is grayed out on the website for that reason.</p>
STOP 1	Stop 1	<p>Stop 1 comes on if the Pivot Stopped Input (labeled on the wiring harness) detects continuity (a closed relay).</p>
STOP 2	Stop 2	<p>Stop 2 is not wired in the standard Marksman harness. It comes on if the controller terminal S2 is grounded. Use it by attaching a relay that will close and connect ground to terminal S2.</p>
NO POWER	Power Loss	<p>This alarm will show if power is lost and the unit is running off of battery backup. The Marksman controller will send out status info and then shut down.</p>
AUX INPUT	Auxillary Input	<p>This alarm means that the auxiliary input is in a state that has triggered a stop. This alarm is by default not a shutdown alarm and is grayed out on the website. To enable this alarm, advanced settings must be changed, consult SureFire.</p> <ol style="list-style-type: none"> 1. If you aren't using an auxiliary input, contact SureFire to disable the alarm 2. Check status and settings on the AUX INFO page (menu 7/7).

Error Messages & Troubleshooting



The Marksman controller has several alarms which will stop the pump. This is a list of these error messages and troubleshooting steps for each.

Controller Message	Website Alarm & Stop Reason	Description and Troubleshooting Steps
BATCH DONE	Batch Complete (alarm)	Batch mode is enabled and the batch amount has been reached. If Irrig Kill Delay is enabled, "IRRIG KILL DELAY" will display on the main screen and count down the minutes until the irrigation kill output is energized.
MEMORY ERROR	Memory Error	A memory error has occurred and settings may have been returned to factory default. Check all user settings are as desired before restarting. If this happens, notify SureFire personnel.
	Batch Complete (no alarm)	Batch mode is enabled and the batch amount has been reached. If this isn't the correct function either increase the batch size or disable batch mode (Menu 3/7)
Pump Stops but no error message shown		Go to Advanced Menu - Diagnostic 2. Look at the LAST STOP # and find the reason on the Diagnostic 2 page in this manual. The last stop # will remain there until the OK button is pushed to start the Marksman.

Controller won't turn on

The Marksman controller is powered by 12 volts DC. The power supply in the VFD Box converts 110 VAC or 480 VAC 3 phase power to 12 VDC for the controller. If your controller will not turn on follow these steps to find and fix the problem.

1. Make sure that the power toggle switch is in the on (up) position.
2. There is a 3 amp automotive style fuse in the main harness. Check fuse visually or check continuity with a multimeter. If fuse failed, replace with 3 amp fuse.



Step 3 & 4 require opening the VFD Control Box where high voltage is present. Do so carefully and do not touch anything or use an uninsulated metal object to touch anything inside the control box. Close and latch the VFD control box immediately when done.

3. If fuse is good, open the VFD control box and observe if the light on the DC power supply labeled "DC ON" or "DC OK" is on.
4. If Light on DC power supply is not on, check circuit breaker(s) in the VFD control box and ensure they are in the up ON position. Red should be showing in observation window below circuit breaker switch.
5. If the above steps do not locate the problem check input AC power and consult an electrician as necessary to provide power to the Marksman.

Recommended Care and Maintenance

H

Maintenance

Winterization

SureFire recommends flushing your fertilizer pump and complete system with adequate amounts of water first. Next, use RV antifreeze to winterize your system by pumping an adequate amount through all components. At the beginning of the next season, begin with water to verify the system is in working order with no leaks.

SureFire recommends storing the Marksman indoors during winter or any season of extended non-use.



SureFire Ag Systems

9904 Hwy 25

Atwood, KS 67730

www.surefireag.com

©2016 SureFire Ag Systems, Inc.—All Rights Reserved

